

LCD Readout Digital Pressure Switch

Series **ZSE3** (For Vacuum)/**ISE3** (For Positive Pressure)

For General Pneumatics

The ZSE3/ISE3 series is to be discontinued. We recommend you consider using the Z/ISE10 series or the Z/ISE20A series digital pressure switch as a substitute. (Dimensions, mounting, and specifications are not compatible.)



RoHS



Easy pressure setting with the digital display

Can be integrated with a vacuum unit, Series ZX



ZSE30
ISE30
ZSE40
ISE40
ZSE10
ISE10
ISE70
ZSE80
ISE80
ZSE□
ISE□
ZSP
PS
ISA2
PSE
IS
ISG
ZSM1

Built-in failure prediction output function

When system performance declines due to filter element clogging, worn vacuum pads, piping leakage, etc., the switch can detect and indicate an oncoming problem before failure occurs.

Two independent outputs

Allows the calibration of two different setpoints e.g. change of vacuum pad size requiring different setpoints, two different supply pressures requiring different pressure confirmation points.

Self-diagnostic function

- Excessive current
- Excessive pressure
- Data error

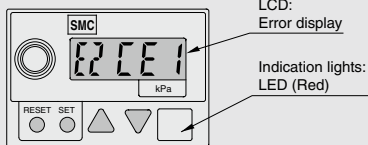

Calibration data

The calibration data is stored in an EEPROM. The EEPROM is rated to keep its memory for 100,000 hours (approx. 11 years) without having power supplied.

Suction filter comes as standard



LCD Readout Digital Pressure Switch RoHS

Series **ZSE3/ISE3**

The ZSE3/ISE3 series is to be discontinued. We recommend you consider using the Z/ISE10 series or the Z/ISE20A series digital pressure switch as a substitute. (Dimensions, mounting, and specifications are not compatible.)

How to Order

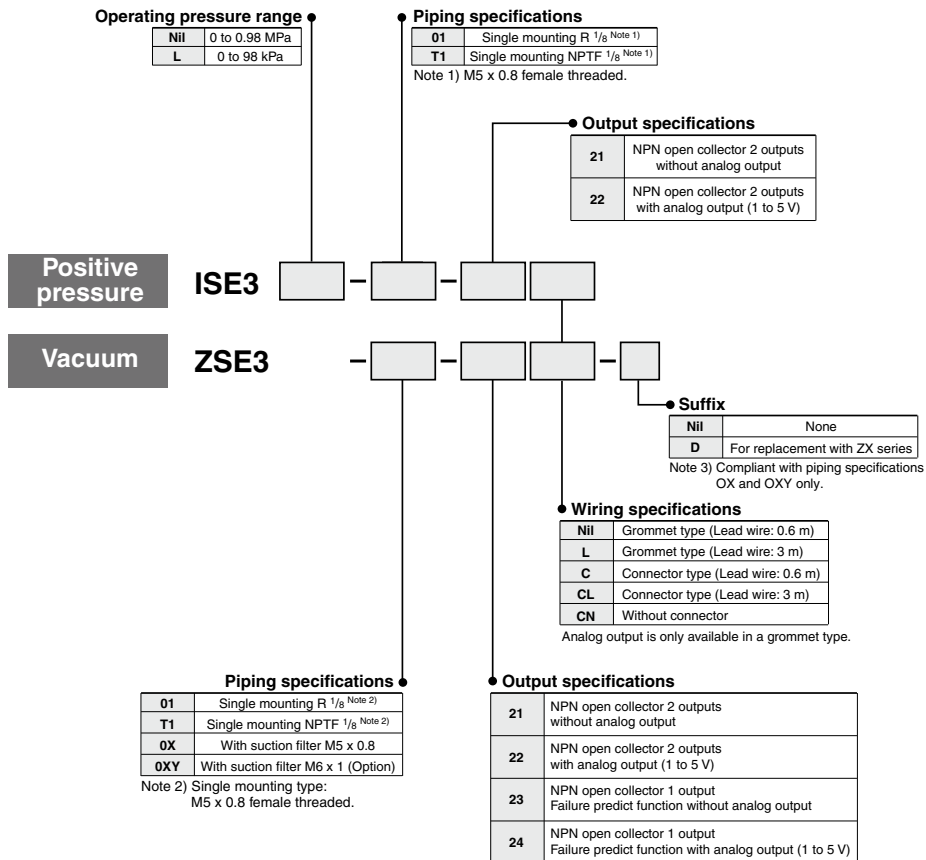

With Connector/How to Order

- Without lead wire (Connector 1 pc., Socket 4 pcs.)... **ZS-20-A**
- With lead wire..... **ZS-20-5A-**

Note 3) When ordering switch with 5 m long lead wire, indicate both part numbers.

Lead wire length

Nil	0.6 m
30	3 m
50	5 m

Ex.) ZSE3-01-21CN..... 1 pc.
ZS-20-5A-50..... 1 pc.

Replacement Element (Filter) Part Number (Refer to page 843)

- Filter vessel assembly (Filter vessel, Filter element)..... **ZX1-FK-PC**
- Filter element **ZX1-FE**
- Filter gasket **ZX1-FG**

LCD Readout Digital Pressure Switch *Series ZSE3/ISE3*

For details about the Pressure Switch Precautions, refer to pages 763 and 764. For details about the Specific Product Precautions, refer to the Operation Manual at SMC website. Click [here](#) for details.

Specifications

Model		Vacuum ZSE3	Positive pressure 100 kPa ISE3L	Positive pressure 1 MPa ISE3
Operating pressure range		0 to -101 kPa	0 to 98 kPa	0 to 0.98 MPa
Max. operating pressure		200 kPa ⁽¹⁾		1 MPa
Min. display unit	kPa	1	1	—
	MPa	—	—	0.01
Indicator light ⁽²⁾		N: When Green LED (OUT1) or Red (OUT2) turns on		
Frequency response		200 Hz		
Hysteresis ⁽³⁾	Hysteresis mode	Adjustable (Variable from 0)		
	Window comparator mode	Fixed (3 digits)		
Fluid		Air, Non-corrosive gases		
Temperature characteristics		±3% F.S. or less		
Repeatability		±1% F.S. or less		
Power supply voltage		12 to 24 VDC ±10%, Ripple (p-p) 10% or less (With power supply polarity protection)		
Switch output		NPN open collector 30 V 80 mA or less		
Current consumption		25 mA or less		
Error display		Red light blinks. Display the error code on LCD.		
Pressure indication		3 1/2 digits (5 mm-size numerals)		
Self-diagnostic function		Overcurrent, Overpressure, Data error Pressure during 0 clear		
Operating temperature range		0 to 60°C (No dewing)		
Noise resistance		1000 Vp-p, Pulse width 1 μs, Rise time 1 ns		
Withstand voltage		1000 VAC in 50/60 Hz for 1 minute between terminals and housing		
Insulation resistance		2 MΩ or more (500 VDC measured via megohmmeter) between terminals and housing		
Lead wire	Connector type	Heat-resistant vinyl electric wire, 4-wire, Conductor area: 0.31 mm ² , Insulator O.D.: 1.55 mm		
	Grommet type	Oilproof heavy-duty vinyl cable -21, -23: 4 cores, ø3.5, Conductor area: 0.14 mm ² , Insulator O.D.: 1.0 mm -22, -24: 5 cores, ø3.5, Conductor area: 0.15 mm ² , Insulator O.D.: 1.0 mm		
Weight		40 g (including 0.6 m-long lead wire)		
Port size		R 1/8, M5 x 0.8, NPTF 1/8, M5 x 0.8 ZX ejector mounted type: M5 x 0.8	R 1/8, M5 x 0.8 NPTF 1/8, M5 x 0.8	
Enclosure		IP40		
Standard		CE, RoHS		

Note 1) Instant pressure supply of 0.5 MPa has no influence on the switch.

Note 2) ZSE3-□-2324; Failure predictive output is Red.

Note 3) Window comparator mode:

The hysteresis is 3 digits, so separate P1 from P2 by 7 digits or more and set them. 1 digit is the minimum pressure display unit. (See the table above.)

ZSE30
ISE30
ZSE40
ISE40
ZSE10
ISE10
ISE70
ZSE80
ISE80
ZSE□
ISE□
ZSP
PS
ISA2
PSE
IS
ISG
ZSM1

Calibration Procedure

Pressure Setting

● 2 output type

1. Input mode for set point value

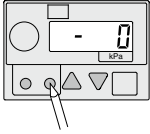

Press the "SET" button.

2. Input set point value for OUT1 (1)

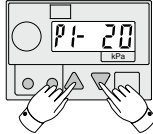

▲ button: Increases set point value
▼ button: Decreases set point value
(Refer to the Table 1.)

3. Input set point value for OUT1 (2)

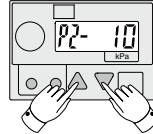

▲ button: Increases set point value
▼ button: Decreases set point value

Press the "SET" button.

4. Input set point value for OUT2 (1)

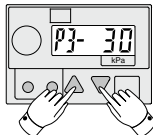

▲ button: Increases set point value
▼ button: Decreases set point value

5. Input set point value for OUT2 (2)

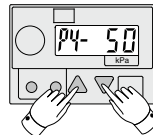

▲ button: Increases set point value
▼ button: Decreases set point value

Press the "SET" button to complete the setting.

P1: Setting of OUT1
P2: Setting of OUT1
P3: Setting of OUT2
P4: Setting of OUT2

Table 1 Output type

Hysteresis mode (P1 ≥ P2, P3 ≥ P4)	Window comparator mode (P1 < P2, P3 < P4)	Note)
<p>Hysteresis (Variable from 0)</p> <p>ON OFF</p> <p>P2 (P4) P1 (P3)</p> <p>Pressure Low -----> High Vacuum Low -----> High</p>	<p>Hysteresis (Fixed)</p> <p>ON OFF</p> <p>P1 (P3) P2 (P4)</p> <p>Pressure Low -----> High Vacuum Low -----> High</p>	<p>Window comparator mode (one for positive pressure is same) Hysteresis is 3 digit, so set P1 and P2 (also P3 and P4) at least 7 digit. * 1 digit is the minimum setting pressure unit.</p>

● 1 output type with failure prediction function

1. Input mode for set point value

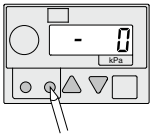

Press the "SET" button.

2. Input set point value for OUT1 (1)

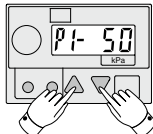

▲ button: Increases set point value
▼ button: Decreases set point value

3. Input set point value for OUT1 (2)

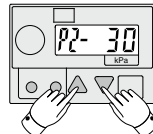

▲ button: Increases set point value
▼ button: Decreases set point value

Press the "SET" button.

4. Calibration of failure predictive pressure

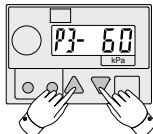

▲ button: Increases set point value
▼ button: Decreases set point value
(Refer to the Table 2.)

5. Calibration of number of failure prediction occurrences

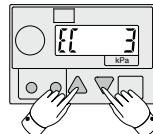

▲ button: Increases set point value
▼ button: Decreases set point value
Occurrence number: 1 to 16 times (0 is not available for prediction.)

Press the "SET" button to complete the setting.

P1: setting of OUT1
P2: setting of OUT2
P3: setting of failure prediction pressure
EC: Number of failure prediction

Table 2 Failure prediction

<p>Vacuum High P3 Set pressure P3 Set pressure P1 Low P2</p> <p>Failure prediction counter Normal 1 time 2 times 3 times</p>	<p>Failure prediction will register when switches turn OFF without reaching the pressure of (P3) after switch turns ON (over P1). Output of failure detection occurs when failure prediction is counted continuously within certain preset levels. The count of failure prediction is reset when switch turns ON (over P1) and pressure exceeds the failure prediction set pressure (P3). (Example of hysteresis mode.)</p>
--	---

Other Functions

● Peak mode high

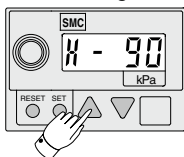

To display the high peak pressure (highest degree of vacuum), press the ▲ button during normal operation. The LCD displays "H". To return back to the normal operation, press the ▲ button again.

● Peak mode low

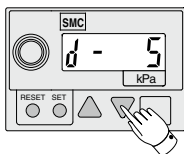

To display the low peak pressure (lowest degree of vacuum), press the ▼ button during normal operation. The LCD displays "d". To return back to the normal operation, press the ▼ button again.

● Reset function

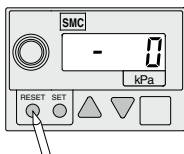

A RESET operation leads to the following results.

- Reset will cause the following during normal operation:
 - Peak high is cleared. Peak low is cleared.
 - Failure prediction counter is cleared.
 - Failure predictive output is reset.
- Reset will cause the following when an error has occurred:
 - Data set in setting mode will remain stored and will return to the same state as when the power is applied. (All calibration data has retained.)
 - In the case of data error, reset the setup mode and then switch will assume normal operation. (All calibration data has retained.)

(Note) Reset Function does not work during setup mode.

Error Correction

Take the following corrective solutions when errors occur.

Display	Description	Solution
E1 dE	Set data was changed by accident, reason unknown.	Perform the RESET operation, and reset all data again.
E2 CE1	OUT1 is short-circuited. Overcurrent is being applied to the load.	Turn off the power and replace the load connected with OUT1 (Black wire).
E2 CE2	OUT 2 is short-circuited. Overcurrent is being applied to the load.	Turn off the power and replace the load connected with OUT2 (White wire).
E3 PE	Pressure exceeding 0.5 MPa is being applied. (The pressure over rated pressure is being applied in case of positive pressure.)	Reset the supply pressure less than 0.5 MPa. (Reduce the supply pressure to below rated pressure in case of rated voltage.)
E4 HP	When performing zero clear, compared with the atmospheric pressure, pressure of more than ± 0.07 MPa for 1 MPa and ± 7 kPa for vacuum is being applied.	Apply atmospheric pressure and then reset the switch.

ZSE30
ISE30

ZSE40
ISE40

ZSE10
ISE10

ISE70

ZSE80
ISE80

ZSE
ISE

ZSP

PS

ISA2

PSE

IS

ISG

ZSM1

Internal Circuits and Wiring Examples

-21 NPN (2 outputs)

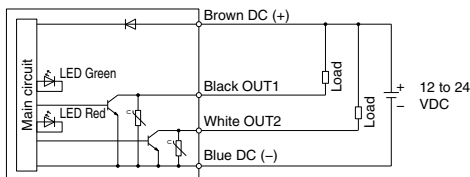

-22 NPN (2 outputs) + Analog voltage output

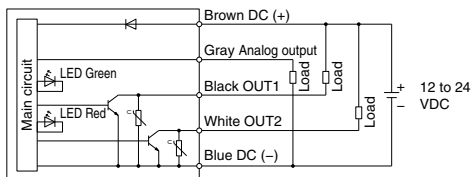

-23 NPN (1 output) + Failure predictive output

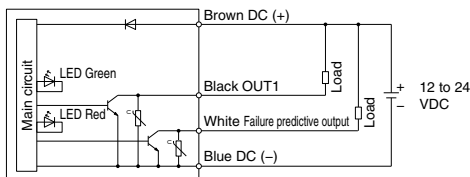

-24 NPN (1 output) + Failure predictive output + Analog voltage output

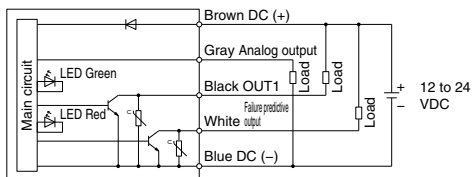

How to Use Connector

1. Attaching and detaching connectors

- When assembling the connector to the switch housing, push the connector straight onto the pins until that lever locks into the housing slot.
- When removing the connector from the switch housing, push the lever down to unlock it from the slot and then withdraw the connector straight off of the pin.

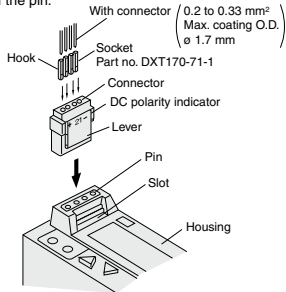

2. Crimping of lead wires and socket

Strip 3.2 to 3.7 mm of the lead wire end, insert each stripped wire into a socket and crimp contact it using special crimping tool. Be careful that the outer insulation of the lead wires does not interfere with socket contact part. (Crimping tool: DXT170-75-1)

3. Attaching and detaching lead wires with sockets

• Attaching

Push the socket into the square holes of the connector (with +, 1, 2, - indication), and continue to push the sockets all the way in until they lock by hooking into the seats in the connector. (When they are pushed in their hooks open and they are locked automatically.) Then confirm that they are locked by pulling lightly on the lead wires.

• Detaching

To detach a socket from connector, pull out lead wire while pressing the socket's hook with a stick having a thin tip (about. 1 mm). If the socket will be used again, first spread the hook outward.

How to Replace Filter Element

Replace the filter element when clogging causes deterioration of the adsorption force or slow response time.

(Element part number: ZX1-FE)

Confirm that the filter gasket is seated in the groove and then reassemble the parts. (Filter gasket part no.: ZX1-FG)

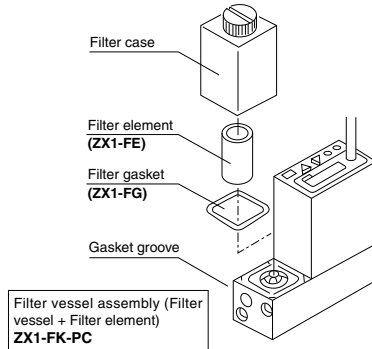

• Regarding the filter vessel

⚠ Caution

1. The vessel is made of polycarbonate. Therefore, do not operate it in an environment that is exposed to chemicals such as thinner, carbon tetrachloride, chloroform, acetic ester, aniline, cyclohexane, trichloroethylene, sulfuric acid, lactic acid, or water-soluble cutting oil (alkalinalic).
2. Operate it away from direct sunlight.

ZSE30
ISE30
ZSE40
ISE40
ZSE10
ISE10
ISE70
ZSE80
ISE80
ZSE □
ISE □
ZSP
PS
ISA2
PSE
IS
ISG
ZSM1

Series ZSE3/ISE3

Dimensions/Switch Only

Grommet type

$\frac{1}{2}$ SE3-⁰¹_{T1} - □

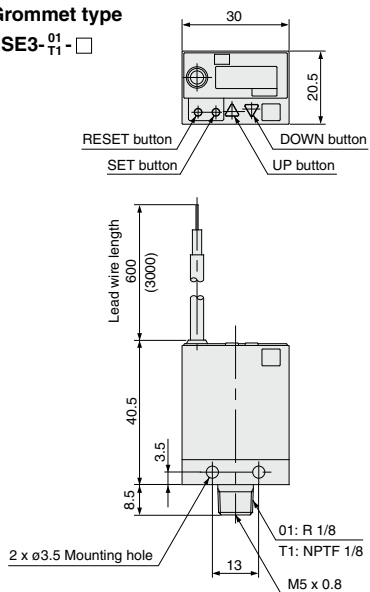

Connector type

$\frac{1}{2}$ SE3-⁰¹_{T1} - □C

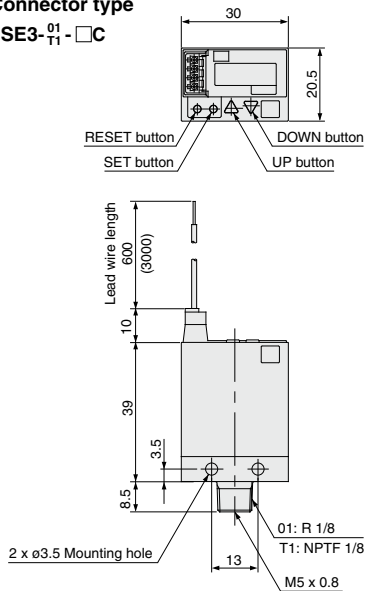

Grommet type

ZSE3-0X□-□

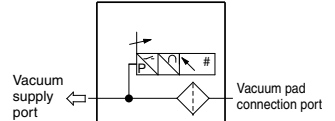
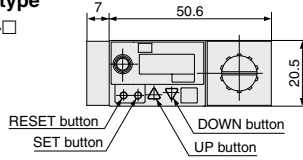

Pneumatic circuit

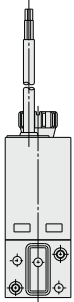

ZSE3-0X□-□-D

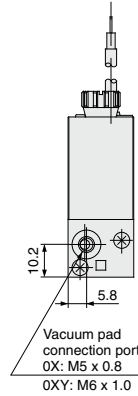
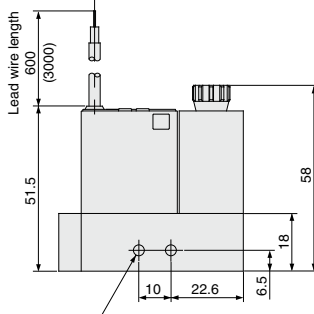
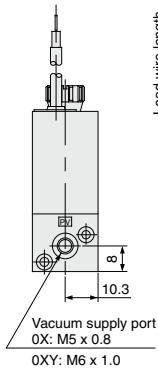

Vacuum supply port
OX: M5 x 0.8
OXY: M6 x 1.0

2 x $\phi 3.3$ Mounting hole

Vacuum pad connection port
OX: M5 x 0.8
OXY: M6 x 1.0

Connector type

ZSE3-0X□-□-C

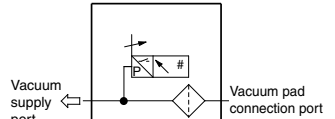
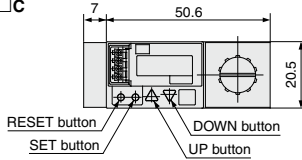

Pneumatic circuit

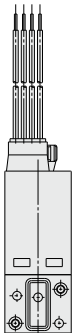

ZSE3-0X□-□-C-D

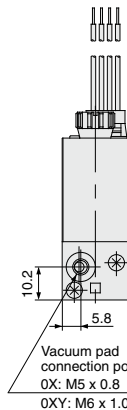
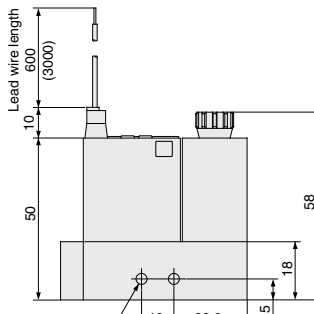
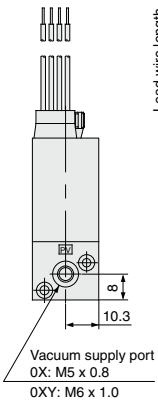

Vacuum supply port
OX: M5 x 0.8
OXY: M6 x 1.0

2 x $\phi 3.3$ Mounting hole

Vacuum pad connection port
OX: M5 x 0.8
OXY: M6 x 1.0

ZSE30
ISE30
ZSE40
ISE40
ZSE10
ISE10
ISE70
ZSE80
ISE80
ZSE□
ISE□
ZSP
PS
ISA2
PSE
IS
ISG
ZSM1