

# M8/M12 Connector

## PCA/EX9/EX500 Series



- Communication Cable/Connector

EtherNet/IP®



EtherCAT®

ETHERNET  
POWERLINK

CC-Link

DeviceNet®



- Power Supply Cable/Connector
- Accessory Between the Sensor/Switch and the Input Device
- Other Accessories
- Made to Order
- Specific Product Precautions

Type 1	EX260
Type 1	EX123/124/126
Type 2	EX500
Type 2	EX600
Type 3	EX245
Type 3	EX250
Type 1	EX120/121/122
Type 1	EX140
Type 1	EX180
Type 2	EX510
	M8/M12
	ATEX

# Communication Cable/Connector ▶ p. 222 to 228

## ● A lineup featuring products applicable to all communication standards

The SMC Fieldbus (SI) Unit can be connected to the PLC (controller) and communication units from other manufacturers with cables with connectors and field-wireable connectors (with shield) applicable to each of the standards.

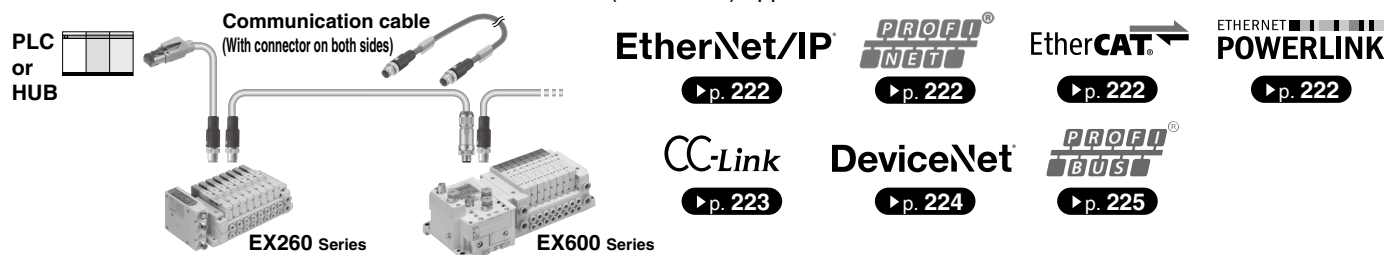

### Communication cable

**SPEEDCON**

**Socket (Female)**  
 ④ For CC-Link  
 ⑧ For DeviceNet®  
 ⑭ For PROFIBUS DP

**SPEEDCON**

**Plug (Male)**  
 ⑤ For CC-Link  
 ⑨ For DeviceNet®  
 ⑮ For PROFIBUS DP  
 ② For EtherNet/IP™, PROFINET, EtherCAT, Ethernet POWERLINK  
 \* ② and ③ are used in combination with each other.

**SPEEDCON**

**Plug (Male)**  
 ① For EtherNet/IP™, PROFINET, EtherCAT, Ethernet POWERLINK

### Field-wireable communication connector

**SPEEDCON** \* Excluding ③

**Plug (Male)**  
 ⑥ For CC-Link ⑪ For DeviceNet®  
 ⑬ For PROFIBUS DP  
 ③ For EtherNet/IP™, PROFINET, EtherCAT, Ethernet POWERLINK  
 \* ② and ③ are used in combination with each other.

**SPEEDCON**

**Socket (Female)**  
 ⑦ For CC-Link  
 ⑫ For DeviceNet®  
 ⑰ For PROFIBUS DP

**RJ45**

### Communication cable (With connector on both sides)

- For EtherNet/IP™, PROFINET, EtherCAT, Ethernet POWERLINK
- For CC-Link
- For DeviceNet®

**SPEEDCON**

### Terminating resistor

Connects to the communication port of the communication unit connected at the end

⑬ For DeviceNet® (Plug)  
 ⑱ For PROFIBUS DP (Plug/B-coded)

## ● Product Table

Description	Application	No.	SMC part no.	Name
Communication cable (With connector on one side)	For Fieldbus communication	①	EX9-AC□EN-PSRJ	Communication cable for EtherNet/IP™, PROFINET, EtherCAT, Ethernet POWERLINK (Plug/D-coded/RJ45)
		②	PCA-1446566	Communication cable for EtherNet/IP™, PROFINET, EtherCAT, Ethernet POWERLINK (Plug/D-coded)
		④	PCA-1567720	Communication cable for CC-Link (Socket)
		⑤	PCA-1567717	Communication cable for CC-Link (Plug)
		⑧	PCA-1557633	Communication cable for DeviceNet® (Socket)
		⑨	PCA-1557646	Communication cable for DeviceNet® (Plug)
		⑭	PCA-1557688	Communication cable for PROFIBUS DP (Socket/B-coded)
		⑮	PCA-1557691	Communication cable for PROFIBUS DP (Plug/B-coded)
Communication cable (With connector on both sides)	For Fieldbus communication		EX9-AC□EN-PSPS	Communication cable for EtherNet/IP™, PROFINET, EtherCAT, Ethernet POWERLINK (Straight)
			EX9-AC□EN-PAPA	Communication cable for EtherNet/IP™, PROFINET, EtherCAT, Ethernet POWERLINK (Angle)
			EX9-AC□MJ-SSPS	Communication cable for CC-Link (Straight)
			EX9-AC□MJ-SAPA	Communication cable for CC-Link (Angle)
			EX9-AC□DN-SSPS	Communication cable for DeviceNet® (Straight)
	EX9-AC□DN-SAPA	Communication cable for DeviceNet® (Angle)		
Field-wireable communication connector	For Fieldbus communication	③	PCA-1446553	Field-wireable connector for EtherNet/IP™, PROFINET, EtherCAT, Ethernet POWERLINK (Plug/D-coded/Fast connection technology)
		⑥	PCA-1075526	Field-wireable connector for CC-Link (Plug/Push-in type)
		⑦	PCA-1075527	Field-wireable connector for CC-Link (Socket/Push-in type)
		⑪	PCA-1075528	Field-wireable connector for DeviceNet® (Plug/Push-in type)
		⑫	PCA-1075529	Field-wireable connector for DeviceNet® (Socket/Push-in type)
		⑰	PCA-1075530	Field-wireable connector for PROFIBUS DP (Plug/B-coded/Push-in type)
		⑱	PCA-1075531	Field-wireable connector for PROFIBUS DP (Socket/B-coded/Push-in type)
Terminating resistor	For Fieldbus communication	⑬	PCA-1557675	Terminating resistor for DeviceNet® (M12)
		⑱	PCA-1557727	Terminating resistor for PROFIBUS DP (M12/B-coded)



# Power Supply Cable/Connector ▶ p. 229 to 236

EX600 ▶ p. 229

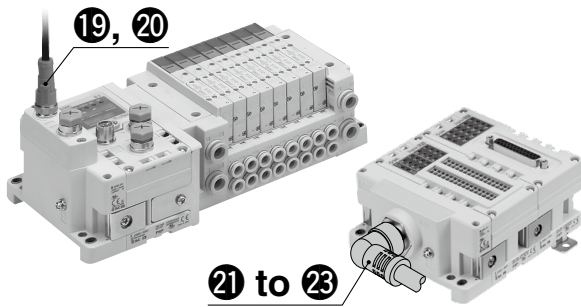

EX500 ▶ p. 231

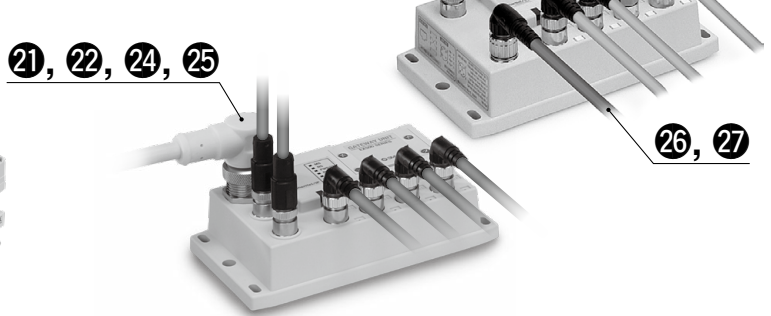

EX260 ▶ p. 233

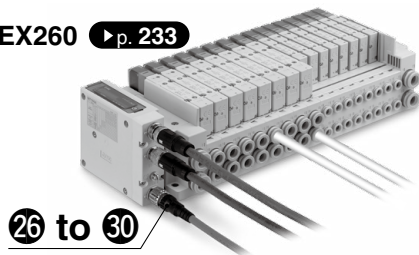

EX250 ▶ p. 235

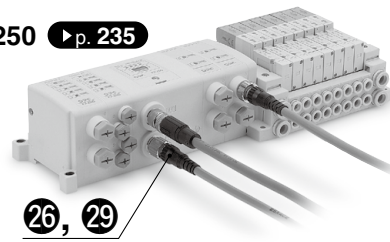

## ● Product Table

Series	Protocols	No.	Part no.	Connector type	Cable length	
EX600	EtherNet/IP™ PROFINET	19	PCA-15649□	M12, 5 pins, B-coded, Socket, Straight, SPEEDCON	2 m, 6 m	
		20	PCA-15649□	M12, 5 pins, B-coded, Socket, Angle, SPEEDCON		
	EtherCAT PROFIBUS DP DeviceNet® CC-Link	End plate EX600-ED3□	21	PCA-15588□	7/8 inch, 5 pins, Socket, Straight	2 m, 6 m
			22	PCA-15588□	7/8 inch, 5 pins, Socket, Angle	
			23	PCA-1578081	Field-wireable connector, 7/8 inch, 5 pins, Socket, Straight	
EX500	EtherNet/IP™	24	PCA-141□	7/8 inch, 4 pins, Socket, Straight	2 m, 6 m	
		25	PCA-141□	7/8 inch, 4 pins, Socket, Angle		
	PROFINET PROFIBUS DP	21	PCA-15588□	7/8 inch, 5 pins, Socket, Straight	2 m, 6 m	
		22	PCA-15588□	7/8 inch, 5 pins, Socket, Angle		
		26	EX500-AP□-S	M12, 5 pins, A-coded, Socket, Straight		1 m, 5 m
27	EX500-AP□-A	M12, 5 pins, A-coded, Socket, Angle				
EX260	EtherNet/IP™ PROFINET	26	EX500-AP□-S	M12, 5 pins, A-coded, Socket, Straight	1 m, 5 m	
		27	EX500-AP□-A	M12, 5 pins, A-coded, Socket, Angle		
	EtherCAT DeviceNet® PROFIBUS DP CC-Link	End plate EX600-ED3□	28	PCA-140180□	M12, 5 pins, A-coded, Socket, Straight, SPEEDCON	1.5 m, 3 m, 5 m
			29	EX9-AC□-1	M12, 5 pins, B-coded, Socket, Straight	
EX250	DeviceNet® CANopen CC-Link	29	EX9-AC□-1	M12, 5 pins, B-coded, Socket, Straight	1 m, 3 m, 5 m	
						26
	EtherNet/IP™ PROFIBUS DP					

Type 1	EX260
Type 2	EX500
Type 3	EX600
	EX245
	EX250
Type 1	EX120/121/122
Type 1	EX140
Type 2	EX180
Type 2	EX510
M8/M12	
ATEX	

# Accessory Between the Sensor/Switch and the Input Device ▶ p. 237 to 239

## ● Connection between connectors and products

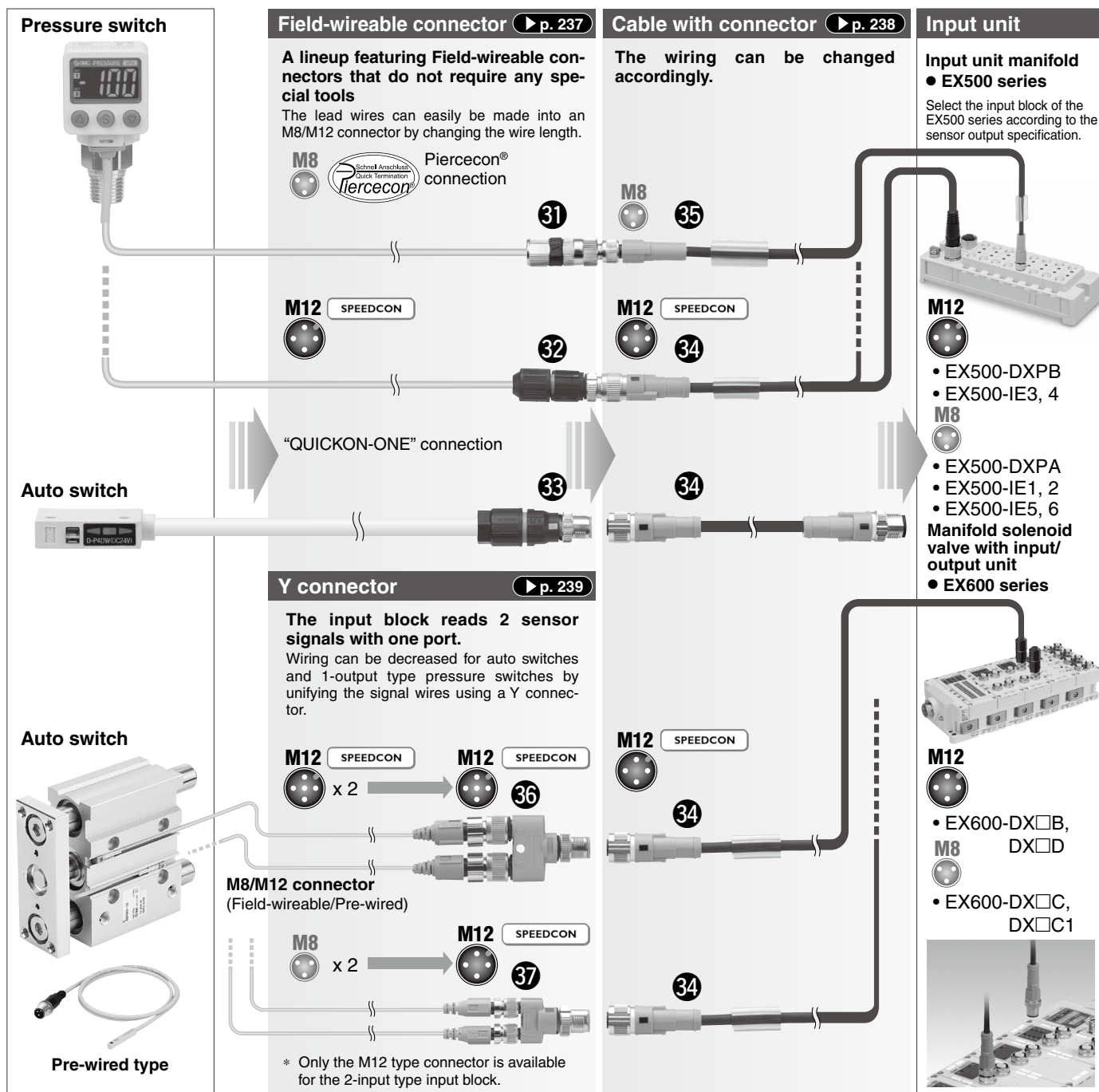

## ● Product Table

Description	Application	No.	SMC part no.	Name
Cable with connector	For sensor	34	PCA-1557769	Cable with M12 connector (4 pins/3 m)
		35	PCA-1557772	Cable with M8 connector (3 pins/3 m)
Field-wireable connector	For sensor	31	PCA-1557730	Field-wireable connector (M8/3 pins/Plug/Piercecon® connection)
		32	PCA-1557743	Field-wireable connector
		33	PCA-1557756	(M12/4 pins/Plug/QUICKON-ONE connection/SPEEDCON)
Y connector	For sensor	36	PCA-1557785	Y connector (2 x M12 (5 pins)-M12 (5 pins)/SPEEDCON)
		37	PCA-1557798	Y connector (2 x M8 (3 pins)-M12 (4 pins)/SPEEDCON)



Other Accessories (EX500/EX9) ▶ p. 240 to 242

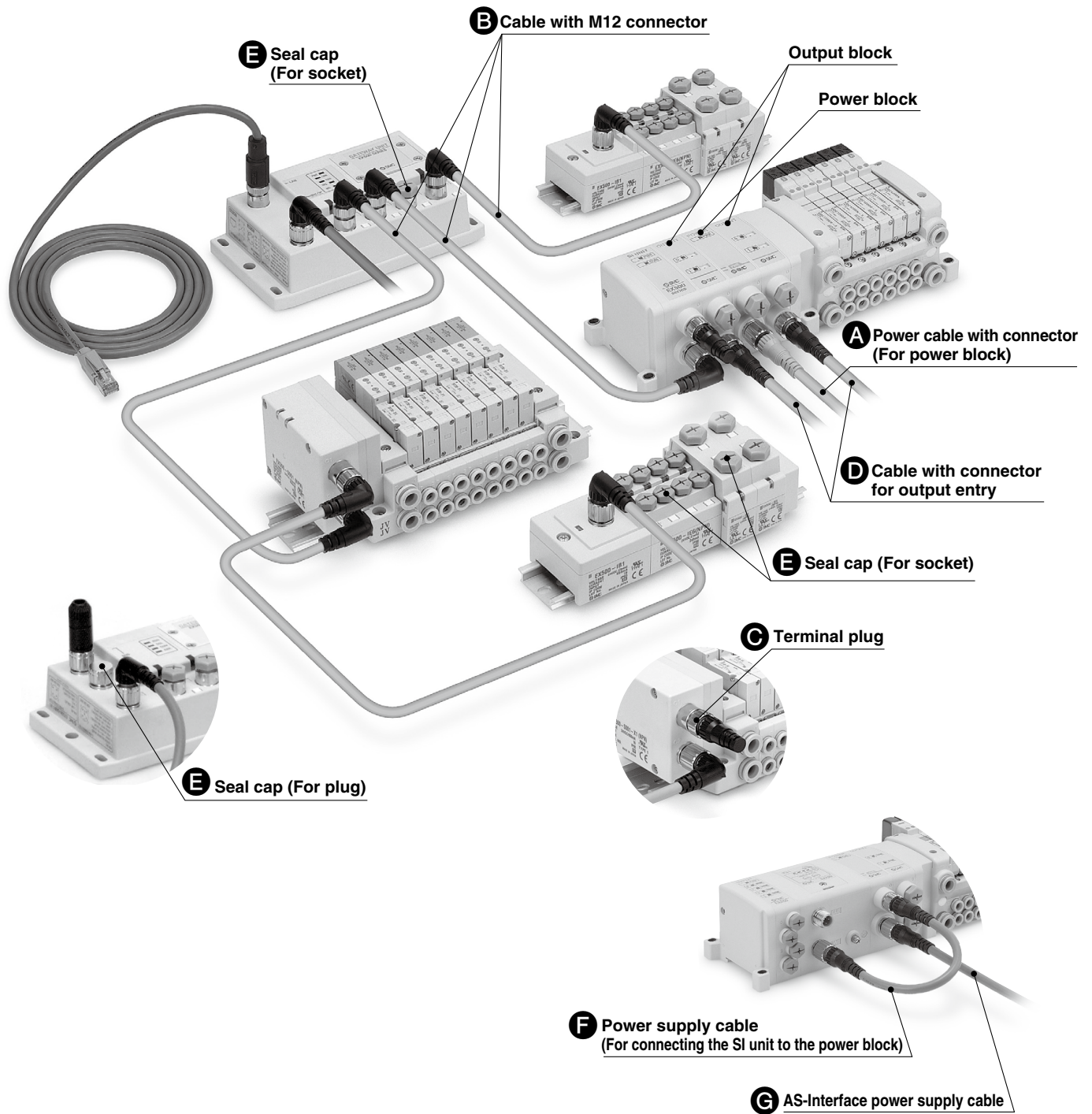

Description	Application	No.	SMC part no.	Name
Cable with connector	For power block	<b>A</b>	<b>EX9-AC□□□-1</b>	Power cable with connector (Socket/B-coded)
	For EX500	<b>B</b>	<b>EX500-AC□□□-SSPS</b>	Cable with M12 connector (8 pins/Both straight)
			<b>EX500-AC□□□-SAPA</b>	Cable with M12 connector (8 pins/Both angle)
Terminal plug	For output entry	<b>D</b>	<b>EX9-AC□□□-7</b>	Cable with M12 connector (Plug/A-coded)
Seal cap	For plug	<b>C</b>	<b>EX500-AC000-S</b>	Terminal plug (M12/8 pins)
		<b>E</b>	<b>EX500-AWTP</b>	Seal cap (M12/For plug)
		<b>E</b>	<b>EX9-AWES</b>	Seal cap (M8/For socket)
Power supply cable	For connecting the SI unit to the power block	<b>F</b>	<b>EX9-AC002-□</b>	Power supply cable (For connecting the SI unit to the power block)
	For the AS-Interface power supply	<b>G</b>	<b>EX9-AC□□□-5</b>	AS-Interface power supply cable (5 pins/Both straight)

Type 1	EX260
	EX123/124/126
Type 2	EX500
Type 3	EX600
	EX245
	EX250
Type 1	EX120/121/122
	EX140
Type 2	EX180
	EX510
M8/M12	
ATEX	

# CONTENTS

## Fieldbus Related Accessories

### M8/M12 Connector *PCA/EX9/EX500 Series*

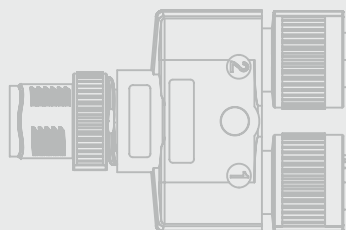
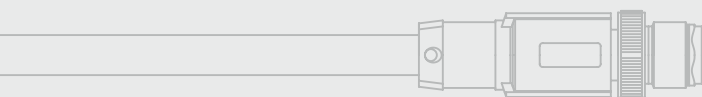
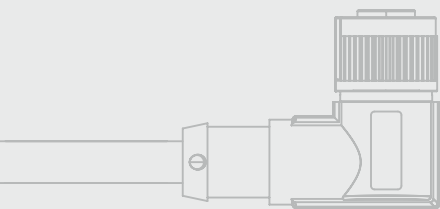

### Communication Cable/Connector

EtherNet/IP™, PROFINET, EtherCAT, Ethernet POWERLINK .....	p. 222
CC-Link .....	p. 223
DeviceNet® .....	p. 224
PROFIBUS DP .....	p. 225
Communication Cable .....	p. 226
Field-wireable Communication Connector .....	p. 228
Terminating Resistor .....	p. 228

### Power Supply Cable/Connector

EX600 Series .....	p. 229
EX500 Series .....	p. 231
EX260 Series .....	p. 233
EX250 Series .....	p. 235

### Accessory Between the Sensor/Switch and the Input Device

Field-wireable Connector .....	p. 237
Cable with Connector .....	p. 238
Y Connector .....	p. 239

### Other Accessories

Ⓐ Power Cable with Connector (For power block) ...	p. 240
Ⓑ Cable with M12 Connector .....	p. 240
Ⓒ Terminal Plug .....	p. 241
Ⓓ Cable with Connector for Output Entry .....	p. 241
Ⓔ Seal Cap: M12 Connector (For plug) .....	p. 241
Ⓕ Seal Cap: M8, M12 Connector (For socket) .....	p. 241
Ⓖ Power Supply Cable (For connecting the SI unit to the power block) ...	p. 242
Ⓗ AS-Interface Power Supply Cable .....	p. 242

### Made to Order

Communication Cable .....	p. 243
Power Supply Cable .....	p. 247

Specific Product Precautions .....	p. 248
------------------------------------	--------



# Communication Cable/Connector

M12

EtherNet/IP®

PROFINET®

EtherCAT®

ETHERNET POWERLINK



## Example of Connection

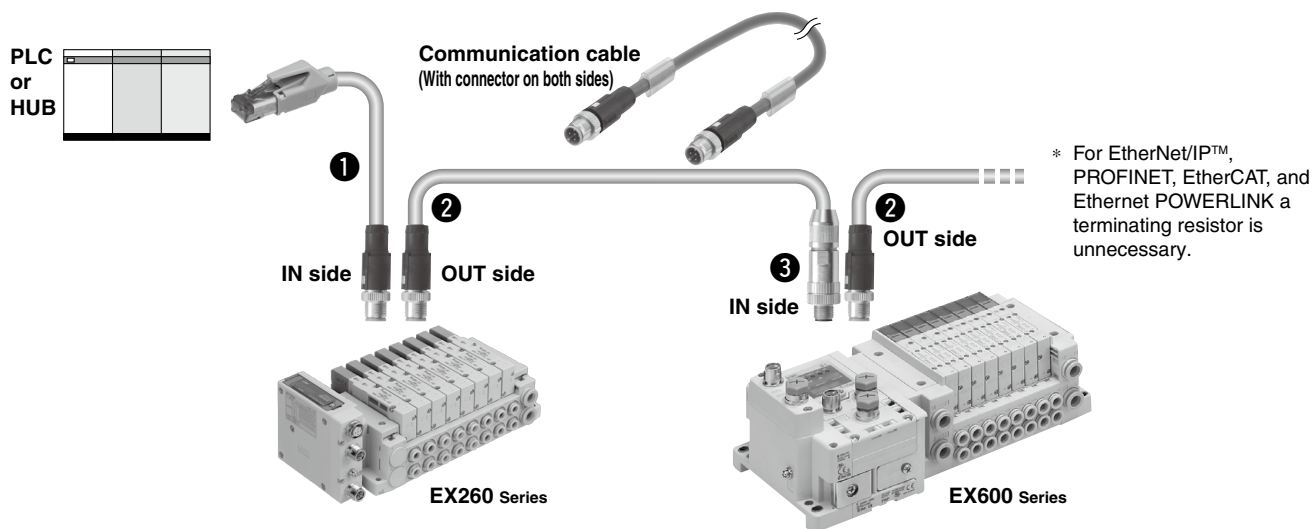

## Specifications



Description		Communication cable (With connector on one side)		Field-wireable connector		
Part no. (Cable length)		EX9-AC010EN-PSRJ (1 m) EX9-AC020EN-PSRJ (2 m) EX9-AC030EN-PSRJ (3 m) EX9-AC050EN-PSRJ (5 m) EX9-AC100EN-PSRJ (10 m)		PCA-1446566		
Product image						
Number of functional poles		M12: 4 pins, RJ45: 8 pins		M12: 4 pins		
Key type		M12: D coded		M12: 4 pins		
Pin assignment		<p>Plug, D-coded (Viewed from the plug side)</p>		<p>1 (Yellow): TD+ 2 (White): RD+ 3 (Orange): TD- 4 (Blue): RD- (PCA-1446566)</p> <p>1 (Orange/White): TD+ 2 (Green/White): RD+ 3 (Orange): TD- 4 (Green): RD- (EX9-AC□EN-PSRJ.PCA-1446553)</p>		
Wiring	Fixed cable length	1 m, 2 m, 3 m, 5 m, 10 m		5 m		
	Cable O.D.	6.4 mm		6.5 mm		
Wiring	Conductor nominal cross section	0.14 mm <sup>2</sup> /AWG26		0.34 mm <sup>2</sup> /AWG22		
	Wire O.D.	0.5 mm		1.55 mm		
Connection type		—		QUICKON connection		
Rating/Performance	Rated current	1 A		4 A		
	Rated voltage	100 V		48 VAC/60 VDC		
	Contact resistance	—		10 mΩ or less		
	Insulation resistance	—		100 MΩ or more		
	Withstand voltage	0.7 kV		1.4 kV		
	Ambient temperature	Connector	-25 to +60°C		-40 to +70°C	
		Cable	-40 to +80°C		—	
Min. bending radius (Fixed)		26 mm		19.5 mm		
Protection class		M12: IP67 (Only with screw tightened), RJ45: IP20		M12: IP67 (Only with screw tightened)		
Allowable repeated insertion/withdrawal		—		100		
Material	Material of knurl	Zinc die-cast (Nickel alloy)		Zinc die-cast (Nickel plating)		
	Contact (Surface treatment)	M12: CuZn (Au plating (Ni underplating)) RJ45: CuSn (Au plating (Ni underplating))		CuZn (Au plating (Ni underplating))		
	Connector material	TPU (UL94 HB)		PA66 (UL94 V0)		
	Material of sheath (Sheath color)	PUR (Blue (RAL 5021 equivalent))		PVC (Green (RAL 6018 equivalent))		
Weight		1 m: Approx. 70 g    5 m: Approx. 252 g 2 m: Approx. 116 g    10 m: Approx. 479 g 3 m: Approx. 161 g		Approx. 350 g		

\*1 The shaded sections show the specifications for the applicable cable. Adaptation for the connector may vary on account of the conductor construction of the electric wire.

Type 1	EX260
Type 2	EX500
Type 3	EX600
Type 1	EX245
Type 1	EX250
Type 1	EX120/121/122
Type 1	EX140
Type 2	EX180
Type 2	EX510
M8/M12	
ATEX	

# Communication Cable/Connector

## Specifications

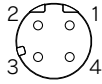
Description		Communication cable (With straight connector on both sides)	Communication cable (With angle connector on both sides)
Part no. (Cable length)		<b>EX9-AC005EN-PSPS</b> (0.5 m) <b>EX9-AC010EN-PSPS</b> (1 m) <b>EX9-AC020EN-PSPS</b> (2 m) <b>EX9-AC030EN-PSPS</b> (3 m) <b>EX9-AC050EN-PSPS</b> (5 m) <b>EX9-AC100EN-PSPS</b> (10 m)	<b>EX9-AC005EN-PAPA</b> (0.5 m) <b>EX9-AC010EN-PAPA</b> (1 m) <b>EX9-AC020EN-PAPA</b> (2 m) <b>EX9-AC030EN-PAPA</b> (3 m) <b>EX9-AC050EN-PAPA</b> (5 m) <b>EX9-AC100EN-PAPA</b> (10 m)
Product image		 <p>Both straight</p>	 <p>Both angle</p>
Number of functional poles		M12: 4 pins	
Key type		M12: D-coded	
Pin assignment		 <p>Plug, D-coded (Viewed from the plug)</p> <p> <b>1 (Yellow) : TD+</b>  <b>2 (White) : RD+</b>  <b>3 (Orange) : TD-</b>  <b>4 (Blue) : RD-</b> </p>	
Wiring	Fixed cable length	0.5 m, 1 m, 2 m, 3 m, 5 m, 10 m	
	Cable O.D.	6.5 mm	
	Conductor nominal cross section	0.34 mm <sup>2</sup> /AWG22	
	Wire O.D. (Including insulating material)	1.55 mm	
Rating/Performance	Rated current	4 A	
	Rated voltage	48 VAC/60 VDC	
	Contact resistance	10 mΩ or less	
	Insulation resistance	100 MΩ or more	
	Withstand voltage	1.4 kV	
	Ambient temperature	-40 to 70°C	
	Min. bending radius (Fixed)	19.5 mm	
	Protection class	M12: IP67 (Only with screw tightened)	
Material	Allowable repeated insertion/withdrawal	100	
	Material of knurl	Zinc die-cast (Nickel plating)	
	Contact (Surface treatment)	CuSn (Au plating (Ni underplating))	
	Connector material	TPU (UL94 HB)	
Material of sheath (Sheath color)		PVC (Green (RAL 6018 equivalent))	
Weight		0.5 m: Approx. 85g 1 m: Approx. 135g 2 m: Approx. 215g 3 m: Approx. 305g 5 m: Approx. 480g 10 m: Approx. 905g	0.5 m: Approx. 85g 1 m: Approx. 135g 2 m: Approx. 215g 3 m: Approx. 305g 5 m: Approx. 480g 10 m: Approx. 905g





# Communication Cable/Connector

M12

CC-Link



## Example of Connection

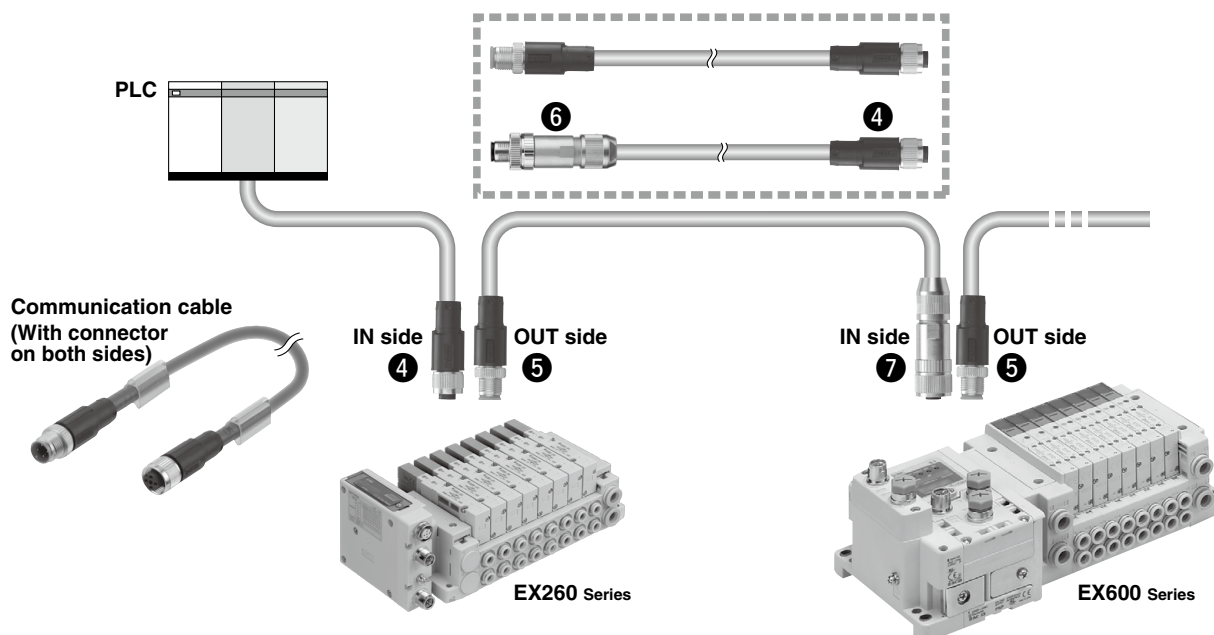

## Specifications

Description		Communication cable (With connector on one side)		Field-wireable connector	
Part no.		PCA-1567720	PCA-1567717	PCA-1075526	PCA-1075527
Product image					
Number of functional poles		M12: 4 pins			
Key type		A-coded (Normal key)			
Pin assignment		 Plug, A-coded*1		 Socket, A-coded	
		* Number of holes: 5, Total number of pins: 4		1: SLD (Shield wire) 2: DB (White) 3: DG (Yellow) 4: DA (Blue)	
Wiring	Fixed cable length	5 m		—	
	Cable O.D.	7.7 mm		Applicable cable*2	4.0 to 8.0 mm
	Conductor nominal cross section	0.5 mm <sup>2</sup> /AWG20			0.14 to 0.75 mm <sup>2</sup> /AWG26 to 18 (Solid cable/Flexible cable) 0.08 to 0.5 mm <sup>2</sup> /AWG28 to 20 (With ferrule)
	Data pair Drain	0.34 mm <sup>2</sup> /AWG22			
	Wire O.D. (Including insulating material)	2.55 mm		—	
Connection type		—			
Rating/Performance	Rated current	4 A			
	Rated voltage	48 VAC/60 VDC			
	Contact resistance	10 mΩ or less		10 mΩ or less	
	Insulation resistance	100 MΩ or more			
	Withstand voltage	1.4 kV			
	Ambient temperature	-20 to +60°C		-40 to +85°C	
	Connector				
	Cable				
	Min. bending radius (Fixed)	77 mm		—	
	Protection class	IP67 (Only with screw tightened)			
Allowable repeated insertion/withdrawal		100			
Material	Material of knurl	Zinc die-cast (Nickel plating)			
	Contact (Surface treatment)	CuSn (Au plating (Ni underplating))			
	Connector material	TPU (UL94 HB)		PA66 (UL94 V0)	
	Material of sheath (Sheath color)	PVC (Red)		—	
Weight		Approx. 306 g	Approx. 308 g	Approx. 37 g	Approx. 42 g

\*1 Can also be connected to an M12 5-pin socket A-coded connector



\*2 The shaded sections show the specifications for the applicable cable. Adaptation for the connector may vary on account of the conductor construction of the electric wire.





# Communication Cable/Connector

## Specifications

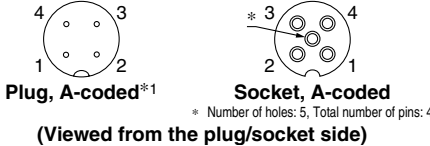
Description		Communication cable (With straight connector on both sides)	Communication cable (With angle connector on both sides)
Part no. (Cable length)		<b>EX9-AC005MJ-SSPS</b> (0.5 m) <b>EX9-AC010MJ-SSPS</b> (1 m) <b>EX9-AC020MJ-SSPS</b> (2 m) <b>EX9-AC030MJ-SSPS</b> (3 m) <b>EX9-AC050MJ-SSPS</b> (5 m) <b>EX9-AC100MJ-SSPS</b> (10 m)	<b>EX9-AC005MJ-SAPA</b> (0.5 m) <b>EX9-AC010MJ-SAPA</b> (1 m) <b>EX9-AC020MJ-SAPA</b> (2 m) <b>EX9-AC030MJ-SAPA</b> (3 m) <b>EX9-AC050MJ-SAPA</b> (5 m) <b>EX9-AC100MJ-SAPA</b> (10 m)
Product image			
Number of functional poles		M12: 5 pins	
Key type		A-coded (Normal key)	
Pin assignment		 <p> <b>Plug, A-coded</b>*1      <b>Socket, A-coded</b>  <small>* Number of holes: 5, Total number of pins: 4</small>  <b>(Viewed from the plug/socket side)</b> </p> <p> <b>1: SLD (Shield wire)</b>  <b>2: DB (White)</b>  <b>3: DG (Yellow)</b>  <b>4: DA (Blue)</b> </p>	
Wiring	Fixed cable length	0.5 m, 1 m, 2 m, 3 m, 5 m, 10 m	
	Cable O.D.	7.7 mm	
	Conductor nominal cross section	0.5 mm <sup>2</sup> /AWG20	
	Wire O.D. (Including insulating material)	1.4 mm	
Rating/Performance	Rated current	4 A	
	Rated voltage	48 VAC/60 VDC	
	Contact resistance	10 mΩ or less	
	Insulation resistance	100 MΩ or more	
	Withstand voltage	1.4 kV	
	Ambient temperature	-20 to +60°C	
	Min. bending radius (Fixed)	77 mm	
	Protection class	IP67 (Only with screw tightened)	
Material	Allowable repeated insertion/withdrawal	100	
	Material of knurl	Zinc die-cast (Nickel plating)	
	Contact (Surface treatment)	CuSn (Au plating (Ni underplating))	
	Connector material	TPU (UL94 HB)	
Material of sheath (Sheath color)		PVC (Red)	
Weight		0.5 m: Approx. 80 g 1 m: Approx. 120 g 2 m: Approx. 200 g 3 m: Approx. 280 g 5 m: Approx. 440 g 10 m: Approx. 840 g	0.5 m: Approx. 80 g 1 m: Approx. 120 g 2 m: Approx. 205 g 3 m: Approx. 285 g 5 m: Approx. 450 g 10 m: Approx. 865 g

\*1 Can also be connected to an M12 5-pin socket A-coded connector

# Communication Cable/Connector

M12



## DeviceNet

### Example of Connection

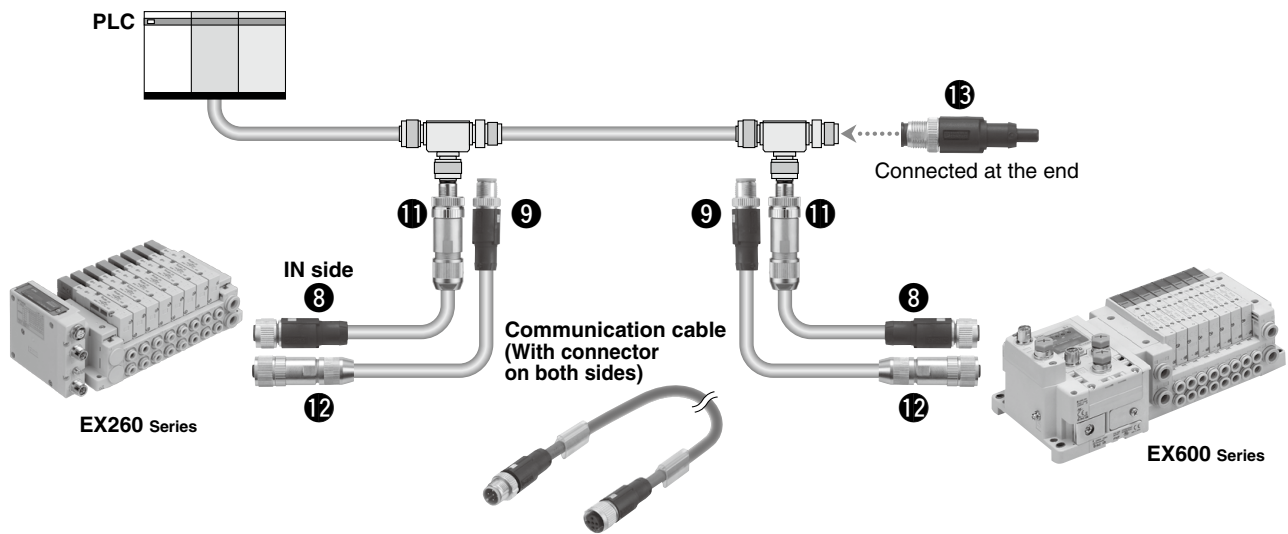

### Specifications

Description		Communication cable (With connector on one side)		Field-wireable connector		Terminating resistor						
Part no. (Cable length)		PCA-1557633		PCA-1557646		PCA-1075528	PCA-1075529	PCA-1557675				
Product image												
Number of functional poles										M12: 5 pins		
Key type										A-coded (Normal key)		
Pin assignment		 Plug, A-coded (Viewed from the plug/socket side)		 Socket, A-coded (Viewed from the plug/socket side)		DeviceNet® / CANopen*2 1: DRAIN      1: — 2: V+ (Red)    2: — 3: V- (Black)   3: CAN GND 4: CAN H (White) 4: CAN H 5: CAN L (Blue) 5: CAN L		1: DRAIN: NC 2: V+: NC 3: V-: NC 4: CAN H 5: CAN L		 121 Ω		
Wiring	Fixed cable length	5 m										
	Cable O.D.	6.7 mm				4.0 to 8.0 mm						
	Conductor nominal cross section	Power pair	0.34 mm <sup>2</sup> /AWG22		Applicable cable*1		0.14 to 0.75 mm <sup>2</sup> /AWG26 to 18 (Solid cable/Flexible cable) 0.08 to 0.5 mm <sup>2</sup> /AWG28 to 20 (With ferrule)					
		Data pair	0.25 mm <sup>2</sup> /AWG24									
	Wire O.D. (Including insulating material)	Power pair	1.4 mm									
Data pair		1.95 mm										
Connection type						Push-in type						
Rating/Performance	Rated current		4 A				4 A					
	Rated voltage		48 VAC/60 VDC				48 VAC/60 VDC					
	Contact resistance		10 mΩ or less				10 mΩ or less				5 mΩ or less	
	Insulation resistance		100 MΩ or more				100 MΩ or more					
	Withstand voltage		1.0 kV				1.0 kV					
	Ambient temperature	Connector	-20 to +80°C				-40 to +85°C				-25 to +90°C	
		Cable										
	Min. bending radius (Fixed)		67 mm									
Protection class						IP67 (Only with screw tightened)						
Allowable repeated insertion/withdrawal		100				100				200		
Material	Material of knurl						Zinc die-cast (Nickel plating)					
	Contact (Surface treatment)		CuSn (Au plating (Ni underplating))				CuSn (Au plating (Ni underplating))					
	Connector material		TPU (UL94 HB)				PA66 (UL94 V0)				TPU (UL94 HB)	
	Material of sheath (Sheath color)		PUR (Purple (RAL 4001 equivalent))									
Weight		Approx. 308 g		Approx. 306 g		Approx. 37 g		Approx. 42 g		Approx. 12 g		



\*1 The shaded sections show the specifications for the applicable cable. Adaptation for the connector may vary on account of the conductor construction of the electric wire.

\*2 Can also be used for CANopen communication

Type 1	EX260
Type 2	EX123/124/126
Type 2	EX500
Type 2	EX600
Type 3	EX245
Type 3	EX250
Type 1	EX120/121/122
Type 1	EX140
Type 1	EX180
Type 2	EX510
Type 2	M8/M12
Type 2	ATEX

# Communication Cable/Connector

## Specifications

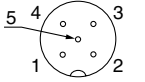
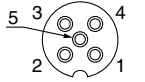
Description		Communication cable (With straight connector on both sides)	Communication cable (With angle connector on both sides)	
Part no. (Cable length)		<b>EX9-AC005DN-SSPS</b> (0.5 m) <b>EX9-AC010DN-SSPS</b> (1 m) <b>EX9-AC020DN-SSPS</b> (2 m) <b>EX9-AC030DN-SSPS</b> (3 m) <b>EX9-AC050DN-SSPS</b> (5 m) <b>EX9-AC100DN-SSPS</b> (10 m)	<b>EX9-AC005DN-SAPA</b> (0.5 m) <b>EX9-AC010DN-SAPA</b> (1 m) <b>EX9-AC020DN-SAPA</b> (2 m) <b>EX9-AC030DN-SAPA</b> (3 m) <b>EX9-AC050DN-SAPA</b> (5 m) <b>EX9-AC100DN-SAPA</b> (10 m)	
Product image				
Number of functional poles		M12: 5 pins		
Key type		A-coded (Normal key)		
Pin assignment		 <b>Plug, A-coded</b> (Viewed from the plug/socket side)	 <b>Socket, A-coded</b>	
		<b>DeviceNet® / CANopen</b> 1: DRAIN            1: — 2: V+ (Red)        2: — 3: V- (Black)      3: CAN GND 4: CAN H (White) 4: CAN H 5: CAN L (Blue)   5: CAN L		
Wiring	Fixed cable length	0.5 m, 1 m, 2 m, 3 m, 5 m, 10 m		
	Cable O.D.	6.7 mm		
	Conductor nominal cross section	Power pair	0.34 mm <sup>2</sup> /AWG22	
		Data pair	0.25 mm <sup>2</sup> /AWG24	
	Wire O.D. (Including insulating material)	Power pair	1.4 mm	
Data pair		1.95 mm		
Rating/Performance	Rated current	4 A		
	Rated voltage	48 VAC/60 VDC		
	Contact resistance	10 mΩ or less		
	Insulation resistance	100 MΩ or more		
	Withstand voltage	1.0 kV		
	Ambient temperature	-20 to +80°C		
	Min. bending radius (Fixed)	67 mm		
	Protection class	IP67 (Only with screw tightened)		
	Allowable repeated insertion/withdrawal	100		
Material	Material of knurl	Zinc die-cast (Nickel plating)		
	Contact (Surface treatment)	CuSn (Au plating (Ni underplating))		
	Connector material	TPU (UL94 HB)		
	Material of sheath (Sheath color)	PUR (Purple (RAL 4001 equivalent))		
Weight		0.5 m: Approx. 75 g 1 m: Approx. 105 g 2 m: Approx. 165 g 3 m: Approx. 225 g 5 m: Approx. 345 g 10 m: Approx. 645 g	0.5 m: Approx. 75 g 1 m: Approx. 105 g 2 m: Approx. 165 g 3 m: Approx. 225 g 5 m: Approx. 345 g 10 m: Approx. 645 g	





# Communication Cable/Connector









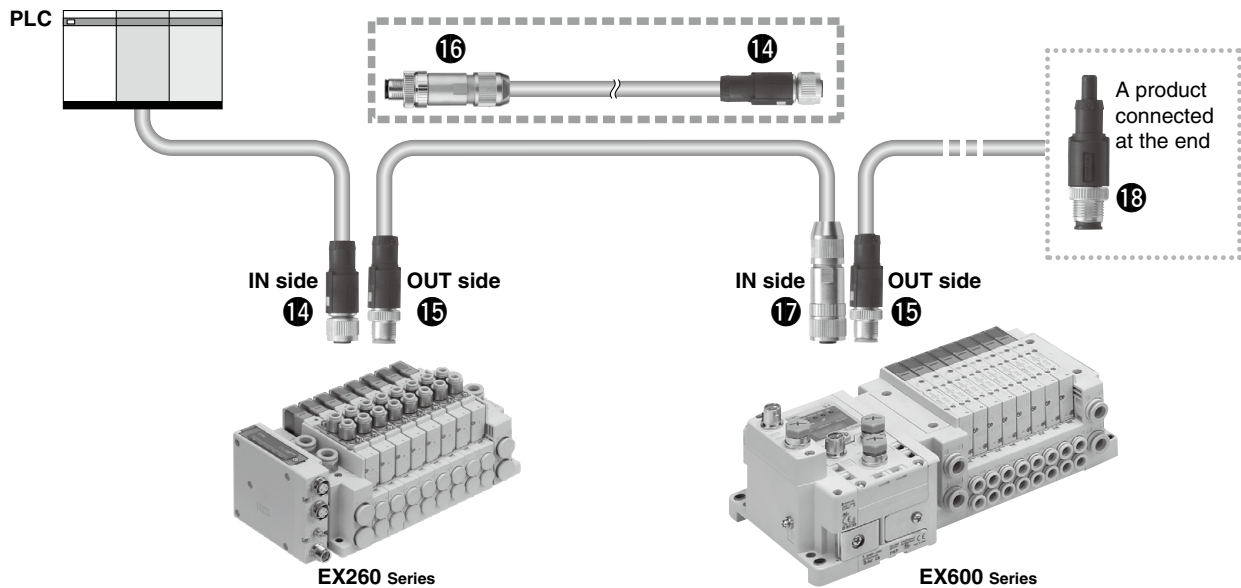

M12



## Example of Connection

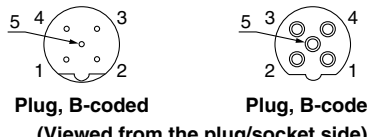

## Specifications

Description		Communication cable (With connector on one side)		Field-wireable connector		Terminal resistor	
Part no.		PCA-1557688	PCA-1557691	PCA-1075530	PCA-1075531	PCA-1557727	
Product image		 Socket	 Plug	 Plug	 Socket	 For PROFIBUS DP (Plug, B-coded)	
Number of functional poles		M12: 2 pins		M12: 3 pins		M12: 4 pins	
Key type		B-coded (Reverse key)					
Pin assignment		 Plug, B-coded (Viewed from the plug/socket side)		1: — 2: A Line (Green) 3: — 4: B Line (Red) 5: —		1: VP  390 Ω 4: B Line  220 Ω 2: A Line  390 Ω 3: DGNND 	
Wiring	Fixed cable length	5 m		—			
	Cable O.D.	7.8 mm		Applicable cable*1	4.0 to 8.0 mm		
	Conductor nominal cross section	0.34 mm <sup>2</sup> /AWG22			0.14 to 0.75 mm <sup>2</sup> /AWG26 to 18 (Solid cable/Flexible cable) 0.08 to 0.5 mm <sup>2</sup> /AWG28 to 20 (With ferrule)		
	Wire O.D. (Including insulating material)	2.55 mm		—			
Connection type		—		Push-in type		—	
Rating/Performance	Rated current		4 A				
	Rated voltage		60 V		48 VAC/60 VAC		60 V
	Contact resistance		5 mΩ or less		10 mΩ or less		5 mΩ or less
	Insulation resistance		100 MΩ or more				
	Withstand voltage		1.4 kV				
	Ambient temperature	Connector	-25 to +90°C		-40 to +85°C		-25 to +90°C
	Cable	-40 to +85°C		—		—	
Min. bending radius (Fixed)		78 mm		—			
Protection class		IP67 (Only with screw tightened)					
Allowable repeated insertion/withdrawal		200					
Material	Material of knurl		Zinc die-cast (Nickel plating)				
	Contact (Surface treatment)		CuSn (Au plating (Ni underplating))				
	Connector material		TPU/PA66 (UL94 HB)		PA66 (UL94 V0)		TPU/PA66 (UL94 HB)
	Material of sheath (Sheath color)		PUR (Purple (RAL 4001 equivalent))		—		
Weight		Approx. 343 g	Approx. 356 g	Approx. 37 g	Approx. 42 g	Approx. 12 g	

\*1 The shaded sections show the specifications for the applicable cable. Adaptation for the connector may vary on account of the conductor construction of the electric wire.

**Communication Cable**

For EtherNet/IP™ For PROFINET For EtherCAT For Ethernet POWERLINK

① EX9-AC 020 EN-PSRJ (Plug/RJ-45 connector)

• Cable length (L)

010	1000 mm
020	2000 mm
030	3000 mm
050	5000 mm
100	10000 mm

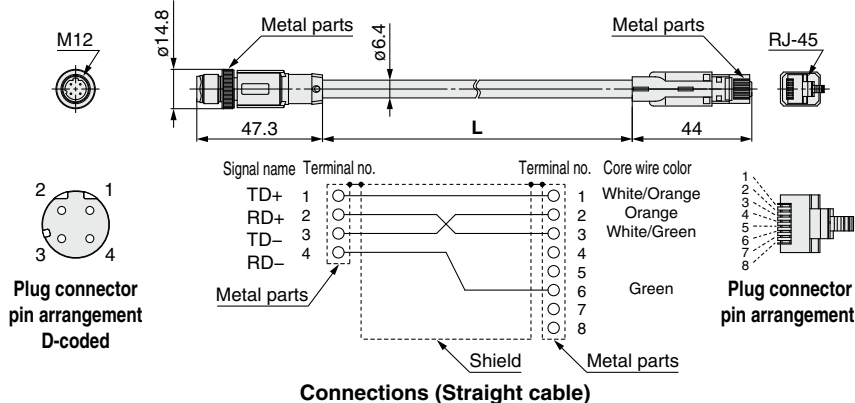

② PCA-1446566 (Plug)

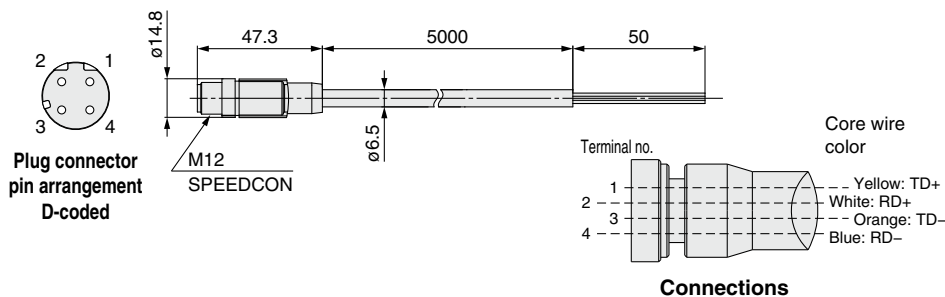

EX9-AC 005 EN-PSPS (With connector on both sides (Plug/Plug))

• Cable length (L)

005	500 mm
010	1000 mm
020	2000 mm
030	3000 mm
050	5000 mm
100	10000 mm

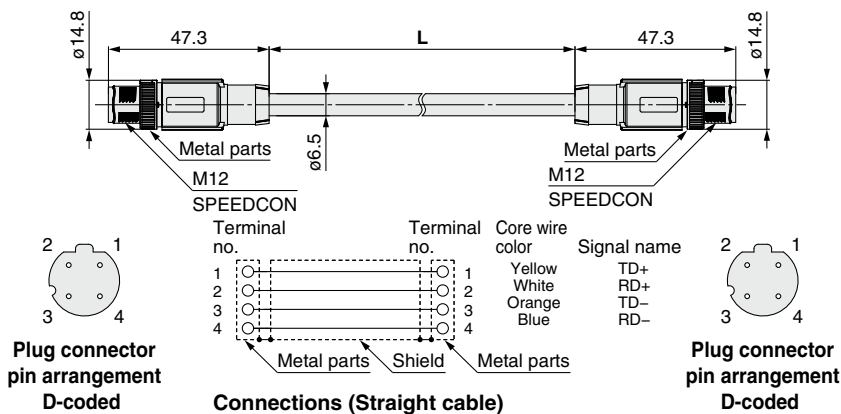

EX9-AC 005 EN-PAPA (With angle connector on both sides (Plug/Plug))

• Cable length (L)

005	500 mm
010	1000 mm
020	2000 mm
030	3000 mm
050	5000 mm
100	10000 mm

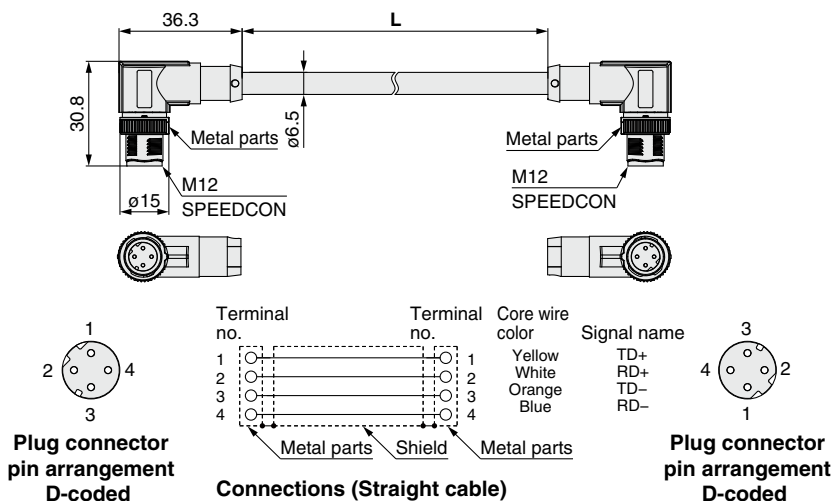

Type 1	EX260
Type 1	EX123/124/126
Type 2	EX500
Type 2	EX600
Type 2	EX245
Type 2	EX250
Type 3	EX120/121/122
Type 1	EX140
Type 1	EX180
Type 2	EX510
M8/M12	
ATEX	

# Communication Cable/Connector

## Communication Cable

For CC-Link

④ PCA-1567720  
(Socket)

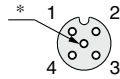

Socket connector pin arrangement  
A-coded (Normal key)

\* Number of holes: 5,  
Total number of pins: 4

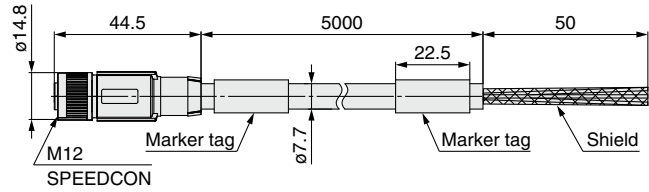

Made to Order

Change in the cable length

p. 246

⑤ PCA-1567717  
(Plug)



Plug connector pin arrangement  
A-coded (Normal key)

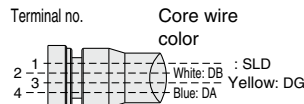
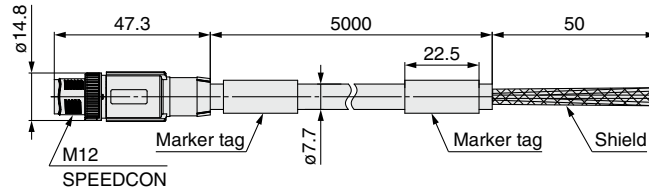

Connections

EX9-AC 005 MJ-SSPS (With connector on both sides (Socket/Plug))

● Cable length (L)

005	500 mm
010	1000 mm
020	2000 mm
030	3000 mm
050	5000 mm
100	10000 mm

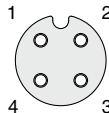
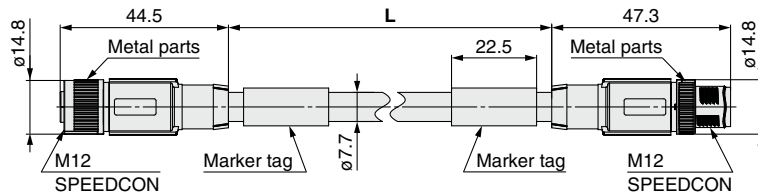

Socket connector pin arrangement  
A-coded (Normal key)

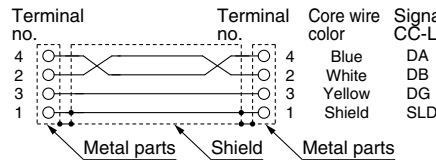

Connections

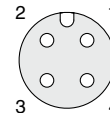

Plug connector pin arrangement  
A-coded (Normal key)

EX9-AC 005 MJ-SAPA (With angle connector on both sides (Socket/Plug))

● Cable length (L)

005	500 mm
010	1000 mm
020	2000 mm
030	3000 mm
050	5000 mm
100	10000 mm

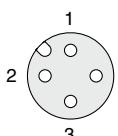
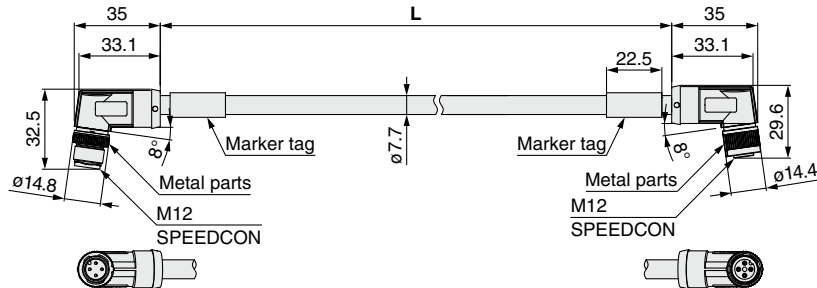

Plug connector pin arrangement  
A-coded (Normal key)

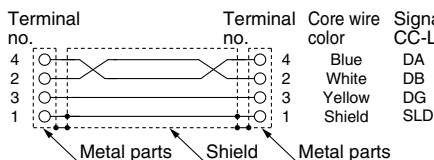

Connections

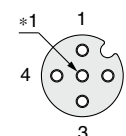

Socket connector pin arrangement  
A-coded (Normal key)

\*1 Number of holes: 5, Total number of pins: 4





# Communication Cable/Connector

## Communication Cable

For DeviceNet®

8 PCA-1557633  
(Socket)



Made to Order

Change in the cable length

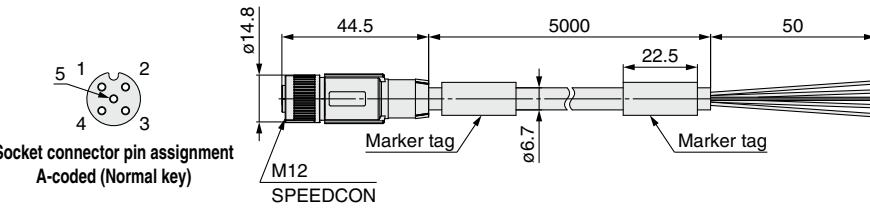

Socket connector pin assignment  
A-coded (Normal key)

9 PCA-1557646  
(Plug)

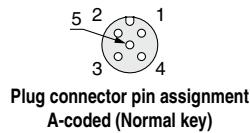

Plug connector pin assignment  
A-coded (Normal key)

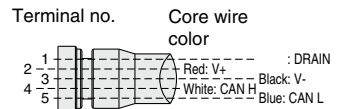

Connections

EX9-AC 005 DN-SSPS (With connector on both sides (Socket/Plug))

• Cable length (L)

005	500 mm
010	1000 mm
020	2000 mm
030	3000 mm
050	5000 mm
100	10000 mm

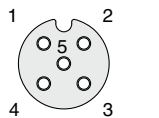
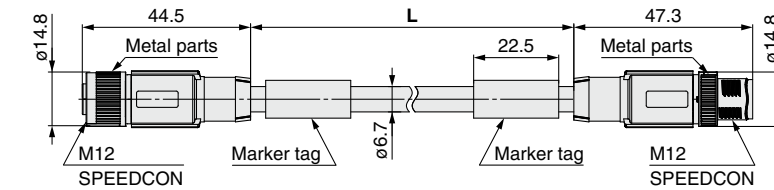

Socket connector pin arrangement  
A-coded (Normal key)

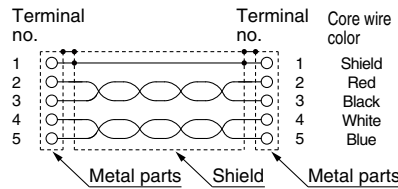

Connections

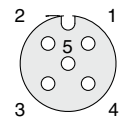

Plug connector pin arrangement  
A-coded (Normal key)

EX9-AC 005 DN-SAPA (With angle connector on both sides (Socket/Plug))

• Cable length (L)

005	500 mm
010	1000 mm
020	2000 mm
030	3000 mm
050	5000 mm
100	10000 mm

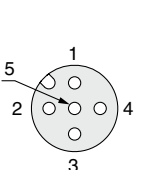
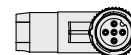
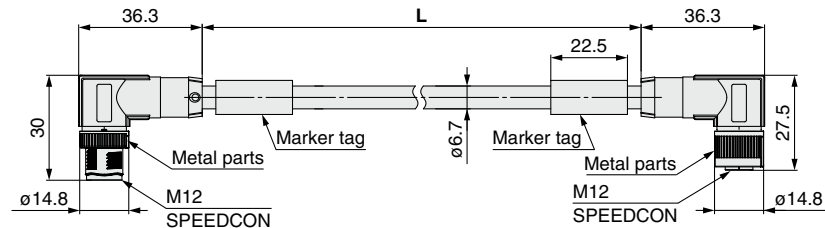

Plug connector pin arrangement  
A-coded (Normal key)

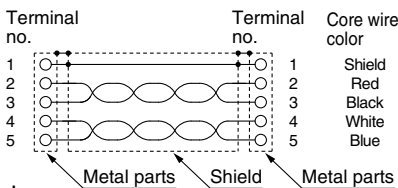

Connections

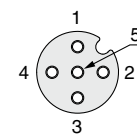

Socket connector pin arrangement  
A-coded (Normal key)

**Communication Cable**

**For PROFIBUS DP**

**14 PCA-1557688**  
(Socket)

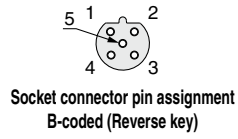

**15 PCA-1557691**  
(Plug)

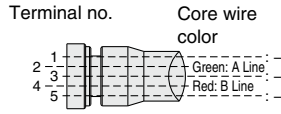
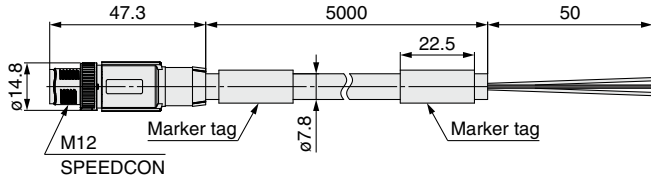
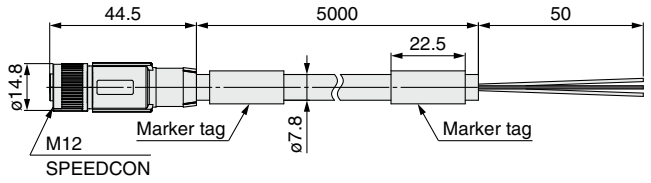
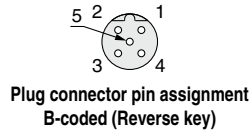

Shield line is connected to the knurl.

**Connections**

Type 1	EX260
Type 1	EX123/124/126
Type 2	EX500
Type 3	EX600
Type 3	EX245
Type 3	EX250
Type 1	EX120/121/122
Type 1	EX140
Type 1	EX180
Type 2	EX510
	M8/M12
	ATEX





**Field-wireable Communication Connector**

**Plug**

For EtherNet/IP™ For PROFINET For EtherCAT

③ PCA-1446553

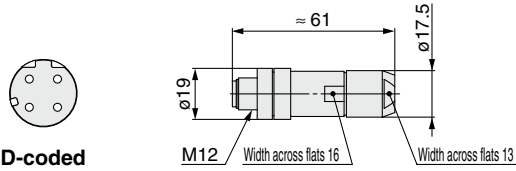

D-coded

**Applicable Cable**

Item	Specifications
Cable O.D.	4.0 to 8.0 mm
Wire gauge (Stranded wire cross section)	0.14 to 0.34 mm <sup>2</sup> /AWG26 to 22

\* The table above shows the specifications for the applicable cable. Adaptation for the connector may vary on account of the conductor construction of the electric wire.

For CC-Link For DeviceNet®

⑥ PCA-1075526 ⑪ PCA-1075528

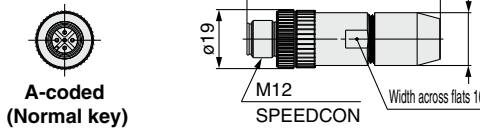

A-coded (Normal key)

For PROFIBUS DP

⑬ PCA-1075530

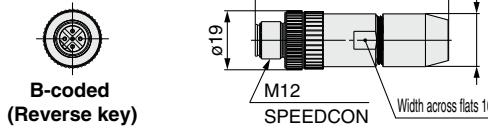

B-coded (Reverse key)

**Applicable Cable**

Item	Specifications
Cable O.D.	4.0 to 8.0 mm
Wire gauge (Stranded wire cross section)	0.14 to 0.75 mm <sup>2</sup> /AWG26 to 18 (Solid cable/Flexible cable) 0.08 to 0.5 mm <sup>2</sup> /AWG28 to 20 (With ferrule)

**Socket**

For CC-Link For DeviceNet®

⑦ PCA-1075527 ⑫ PCA-1075529

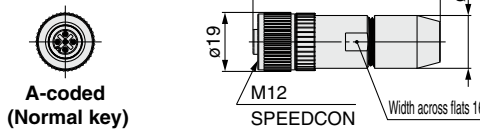

A-coded (Normal key)

For PROFIBUS DP

⑭ PCA-1075531

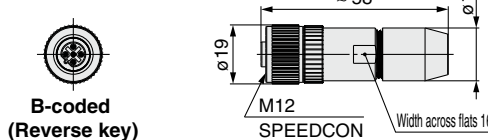

B-coded (Reverse key)

**Applicable Cable**

Item	Specifications
Cable O.D.	4.0 to 8.0 mm
Wire gauge (Stranded wire cross section)	0.14 to 0.75 mm <sup>2</sup> /AWG26 to 18 (Solid cable/Flexible cable) 0.08 to 0.5 mm <sup>2</sup> /AWG28 to 20 (With ferrule)

**Terminating Resistor**

For DeviceNet®

⑬ PCA-1557675  
Terminating resistor for DeviceNet®

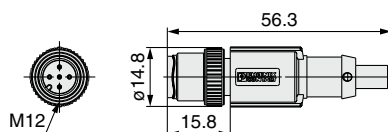

For PROFIBUS DP

⑭ PCA-1557727  
Terminating resistor for PROFIBUS DP

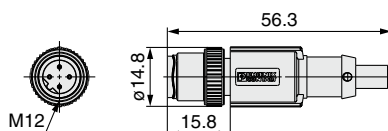

Type 1	EX260
Type 2	EX123/124/126
Type 2	EX500
Type 3	EX600
Type 3	EX245
Type 3	EX250
Type 1	EX120/121/122
Type 1	EX140
Type 1	EX180
Type 2	EX510
	M8/M12
	ATEX

# Power Supply Cable/Connector

## EX600 Series

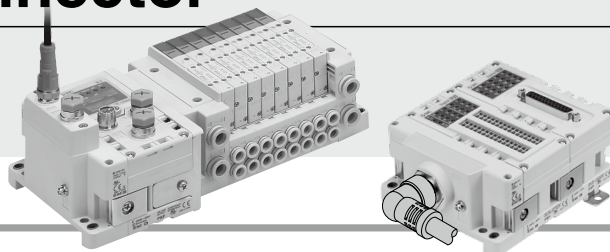

### Specifications

Description		Power supply cable (With connector on one side)				Field-wireable connector		
Part no. (Cable length)		19	20	21	22	23 PCA-1578081		
		PCA-1564927 (2 m) PCA-1564930 (6 m)	PCA-1564943 (2 m) PCA-1564969 (6 m)	PCA-1558810 (2 m) PCA-1558823 (6 m)	PCA-1558836 (2 m) PCA-1558849 (6 m)			
Protocol		EtherNet/IP™, PROFINET, EtherCAT, PROFIBUS DP, DeviceNet®, CC-Link						
Number of functional poles		M12: 5 pins			7/8 inch: 5 pins			
Key type		B-coded			—			
Wiring	Cable O.D.	5.9 mm			12.58 mm		Applicable cable*1	
	Conductor nominal cross section	AWG22			AWG16			12.0 to 14.0 mm
	Wire O.D. (Including insulating material)	1.27 mm			2.35 mm		0.34 to 1.5 mm <sup>2</sup> /AWG22 to 16	
Connection type		—			Screw tightening			
Rating/Performance	Rated current	4 A			8 A		9 A	
	Rated voltage	60 V			600 V		250 V	
	Contact resistance	5 mΩ or less						
	Insulation resistance	100 MΩ or more						
	Withstand voltage	1.0 kV			1.4 kV		4 kV	
	Ambient temperature	Connector	-25 to +90°C			-25 to +80°C		-25 to +85°C
		Cable	-25 to +80°C			-10 to +105°C		—
	Min. bending radius (Fixed)	59 mm			110 mm		—	
	Protection class	IP67 (Only with screw tightened)						
	Allowable repeated insertion/withdrawal	200			100		50	
Material	Material of knurl	Zinc die-cast (Nickel plating)			Brass (Nickel plating)		Zinc die-cast (Nickel plating)	
	Contact (Surface treatment)	CuSn (Au plating (Ni underplating))					CuZn (Au plating (Ni underplating))	
	Connector material	TPU (UL94 HB)			PUR (UL94 HB)		PUR/PA66/PBT (UL94 HB)	
	Material of sheath (Sheath color)	PUR (Black-Gray (RAL 7021 equivalent))			PVC (Yellow (RAL 1021 equivalent))		—	
Weight		2 m: Approx. 113 g 6 m: Approx. 425 g	2 m: Approx. 130 g 6 m: Approx. 475 g	2 m: Approx. 446 g 6 m: Approx. 1270 g	2 m: Approx. 455 g 6 m: Approx. 1300 g	Approx. 47.6 g		

\*1 The shaded sections show the specifications for the applicable cable. Adaptation for the connector may vary on account of the conductor construction of the electric wire.

## Power Supply Cable/Connector

### 19/20 PCA-1564927

#### Socket specification, Cable length (L)

1564927	Straight 2 m
1564930	Straight 6 m
1564943	Angle 2 m
1564969	Angle 6 m

Item	Specifications
Cable O.D.	ø5.9 mm
Conductor nominal cross section	0.34 mm <sup>2</sup> /AWG22
Wire O.D. (Including insulator)	1.27 mm
Min. bending radius (Fixed)	59 mm

#### Straight connector type

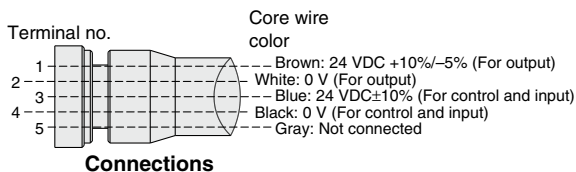
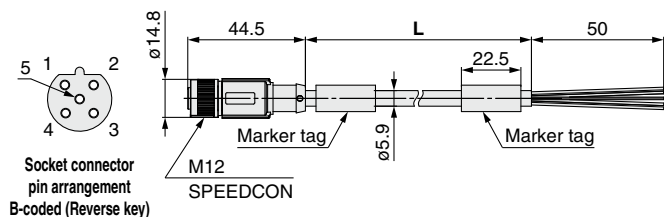

#### Angle connector type

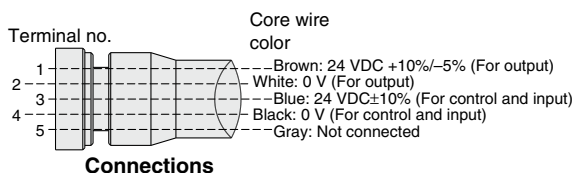
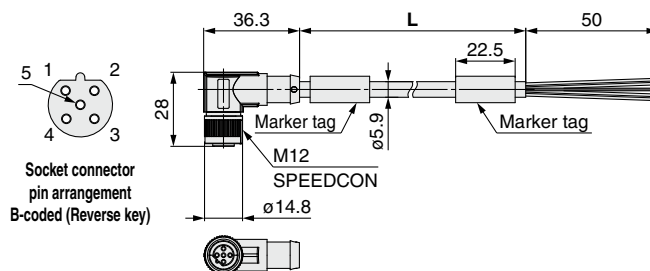

### 21/22 PCA-1558810

#### Socket specification, Cable length (L)

1558810	Straight 2 m
1558823	Straight 6 m
1558836	Angle 2 m
1558849	Angle 6 m

Item	Specifications
Cable O.D.	ø12.58 mm
Conductor nominal cross section	1.5 mm <sup>2</sup> /AWG16
Wire O.D. (Including insulator)	2.35 mm
Min. bending radius (Fixed)	110 mm

#### Straight connector type

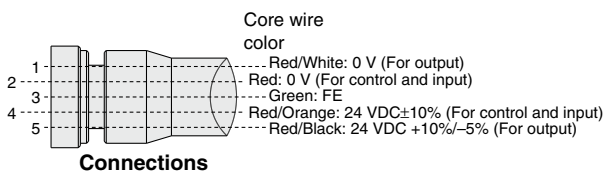
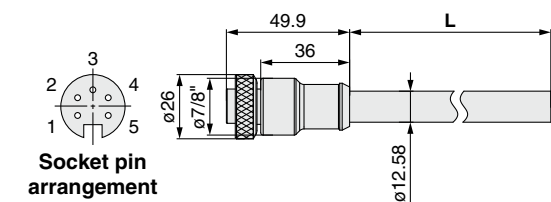

#### Angle connector type

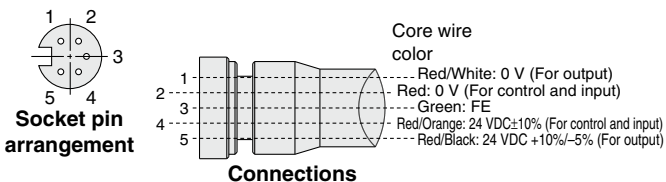
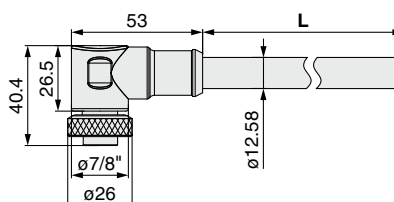

## Socket

### 23 PCA-1578081

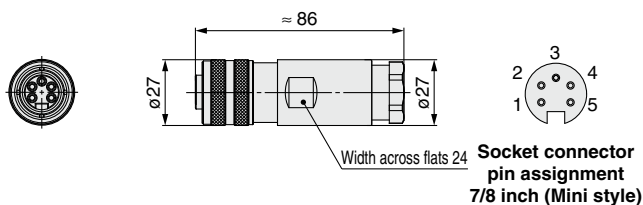

Type 1  
EX260  
EX123/124/126

Type 2  
EX500  
EX600  
EX245

Type 3  
EX250  
EX120/121/122  
EX140  
EX180  
EX510  
M8/M12  
ATEX

# Power Supply Cable/Connector

## EX500 Series

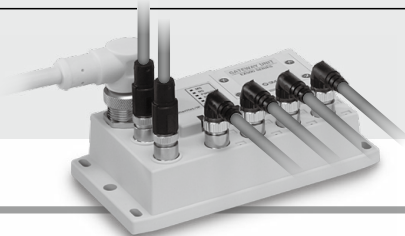

### Specifications/Gateway Decentralized System 2 (128 Points)

Description		Power supply cable (With connector on one side)				
Part no. (Cable length)		②④ PCA-1415999 (2 m) PCA-1415996 (6 m)	②⑤ PCA-1416000 (2 m) PCA-1415997 (6 m)	②① PCA-1558810 (2 m) PCA-1558823 (6 m)	②② PCA-1558836 (2 m) PCA-1558849 (6 m)	
Protocol		EtherNet/IP™		PROFINET		
Number of functional poles		7/8 inch: 4 pins		7/8 inch: 5 pins		
Key type		—				
Wiring	Cable O.D.	10.7 mm		12.58 mm		
	Conductor nominal cross section	1.5 mm <sup>2</sup> /AWG16		1.5 mm <sup>2</sup> /AWG16		
	Wire O.D. (Including insulating material)	2.35 mm		2.35 mm		
Rating/Performance	Rated current	10 A		8 A		
	Rated voltage	600 V		600 V		
	Contact resistance	5 mΩ or less				
	Insulation resistance	100 MΩ or more				
	Withstand voltage	1.4 kV				
	Ambient temperature	Connector	-25 to 80°C			
		Cable	-30 to +105°C		-10 to +105°C	
	Min. bending radius (Fixed)	94 mm		110 mm		
	Protection class	IP67 (Only with screw tightened)				
	Allowable repeated insertion/withdrawal	100				
Material	Material of knurl	Brass (Nickel plating)		Brass (Nickel plating)		
	Contact (Surface treatment)	CuSn (Au plating)				
	Connector material	PUR (UL94 HB)				
	Material of sheath (Sheath color)	PVC (Yellow (RAL 1021 equivalent))				
Weight		2 m: Approx. 385 g 6 m: Approx. 1065 g	2 m: Approx. 395 g 6 m: Approx. 1075 g	2 m: Approx. 446 g 6 m: Approx. 475 g	2 m: Approx. 455 g 6 m: Approx. 1300 g	

### Specifications/Gateway Decentralized System (64 Points)

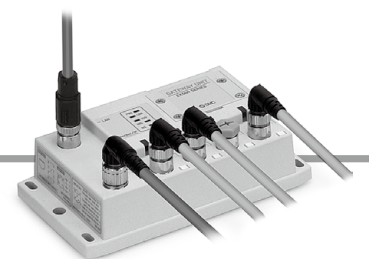

Description		Power supply cable (With connector on one side)		
Part no. (Cable length)		②⑥ EX500-AP010-S (1 m) EX500-AP050-S (5 m)	②⑦ EX500-AP010-A (1 m) EX500-AP050-A (5 m)	
Protocol		PROFIBUS DP		
Number of functional poles		M12: 5 pins		
Key type		A-coded		
Wiring	Cable O.D.	6 mm		
	Conductor nominal cross section	0.3 mm <sup>2</sup> /AWG22		
	Wire O.D. (Including insulating material)	1.5 mm		
Rating/Performance	Rated current	3 A		
	Rated voltage	125 V		
	Contact resistance	40 mΩ or less		
	Insulation resistance	1000 MΩ or more		
	Withstand voltage	1.5 kV		
	Ambient temperature	Connector	-25 to +60°C	
		Cable	-25 to +60°C	
	Min. bending radius (Fixed)	40 mm		
	Protection class	IP67 (Only with screw tightened)		
	Allowable repeated insertion/withdrawal	200		
Material	Material of knurl	Brass (Nickel plating)		
	Contact (Surface treatment)	Phosphor bronze (Au plating)		
	Connector material	Soft PBT (UL94 V0)		
	Material of sheath (Sheath color)	PVC (Light gray)		
Weight		1 m: Approx. 80 g 5 m: Approx. 395 g	1 m: Approx. 85 g 5 m: Approx. 400 g	



Power Supply Cable/Gateway Decentralized System 2 (128 Points)

For EtherNet/IP™

②⑤ PCA-1416000

Connector specification, Cable length (L)

1415999	Straight 2 m
1415996	Straight 6 m
1416000	Angle 2 m
1415997	Angle 6 m

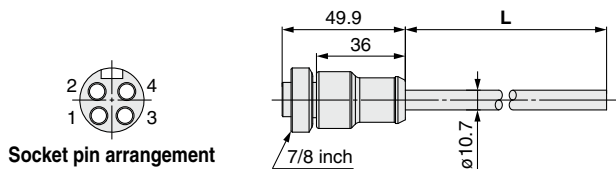

Socket pin arrangement

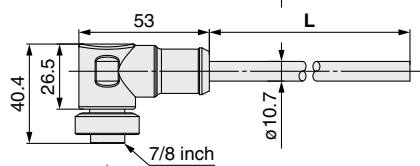

Socket pin arrangement

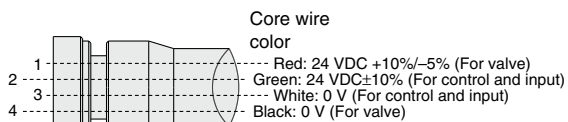

Connections

- Red: 24 VDC +10%/-5% (For valve)
- Green: 24 VDC±10% (For control and input)
- White: 0 V (For control and input)
- Black: 0 V (For valve)

Item	Specifications
Cable O.D.	10.7 mm
Conductor nominal cross section	1.5 mm <sup>2</sup> /AWG16
Min. bending radius (Fixed)	94 mm

For PROFINET

②② PCA-1558810

Connector specification, Cable length (L)

1558810	Straight 2 m
1558823	Straight 6 m
1558836	Angle 2 m
1558849	Angle 6 m

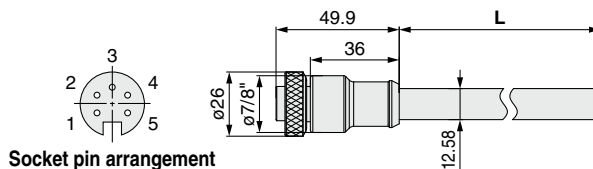

Socket pin arrangement

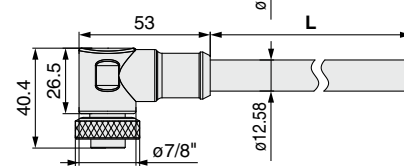

Socket pin arrangement

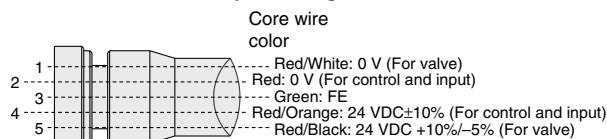

Connections

Item	Specifications
Cable O.D.	12.58 mm
Conductor nominal cross section	1.5 mm <sup>2</sup> /AWG16
Wire O.D. (Including insulator)	2.35 mm
Min. bending radius (Fixed)	110 mm

Power Supply Cable/Gateway Decentralized System (64 Points)

For PROFIBUS DP

②⑦ EX500-AP 050 - S

Cable length (L)

010	1000 mm
050	5000 mm

Connector specification

S	Straight
A	Angle

Straight connector type

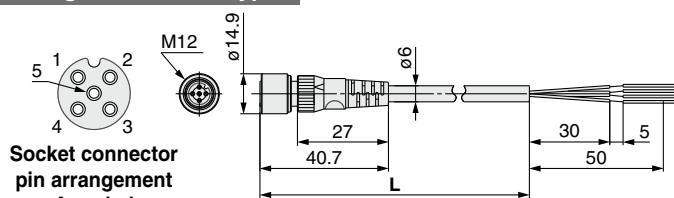

Socket connector pin arrangement A-coded (Normal key)

Item	Specifications
Cable O.D.	6 mm
Conductor nominal cross section	0.3 mm <sup>2</sup> /AWG22
Wire O.D. (Including insulator)	1.5 mm
Min. bending radius (Fixed)	40 mm

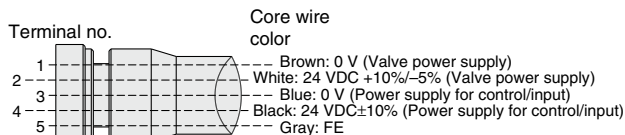

Connections (PROFIBUS DP)

Angle connector type

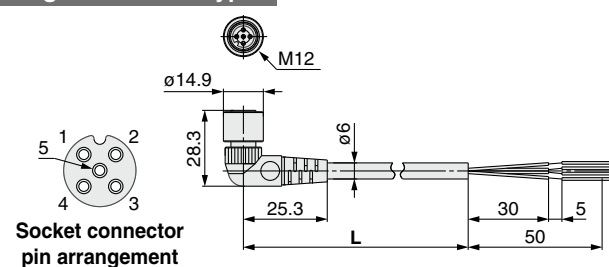

Socket connector pin arrangement A-coded (Normal key)

Item	Specifications
Cable O.D.	6 mm
Conductor nominal cross section	0.3 mm <sup>2</sup> /AWG22
Wire O.D. (Including insulator)	1.5 mm
Min. bending radius (Fixed)	40 mm



Made to Order

Cable length	10000 mm	p. 247
--------------	----------	--------

Type 1	EX260
Type 1	EX123/124/126
Type 2	EX500
Type 2	EX600
Type 3	EX245
Type 3	EX250
Type 1	EX120/121/122
Type 1	EX140
Type 1	EX180
Type 2	EX510
M8/M12	
ATEX	

# Power Supply Cable/Connector

## EX260 Series

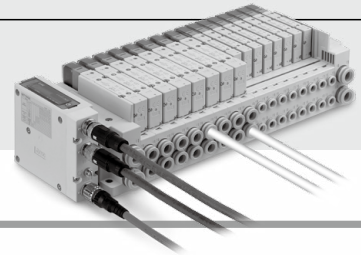

### Specifications

Description	Power supply cable (With connector on one side)					
Part no. (Cable length)	②⑥ EX500-AP010-S (1 m) EX500-AP050-S (5 m)	②⑦ EX500-AP010-A (1 m) EX500-AP050-A (5 m)	②⑧ PCA-1401804 (1.5 m) PCA-1401805 (3 m) PCA-1401806 (5 m)	②⑨ EX9-AC010-1 (1 m) EX9-AC030-1 (3 m) EX9-AC050-1 (5 m)	③⑩ PCA-1401807 (1.5 m) PCA-1401808 (3 m) PCA-1401809 (5 m)	
Protocol	PROFIBUS DP, DeviceNet®, EtherCAT, PROFINET, EtherNet/IP™			CC-Link		
Number of functional poles	M12: 5 pins					
Key type	A-coded		B-coded			
Wiring	Cable O.D.	6 mm	5 mm	6.6 mm	5 mm	
	Conductor nominal cross section	0.3 mm <sup>2</sup> /AWG22	AWG22	0.3 mm <sup>2</sup> /AWG22	AWG22	
	Wire O.D. (Including insulating material)	1.5 mm	1.27 mm	1.65 mm	1.27 mm	
Rating/Performance	Rated current	3 A	4 A	3.1 A	4 A	
	Rated voltage	125 V	60 V	125 V	60 V	
	Contact resistance	40 mΩ or less	5 mΩ or less	40 mΩ or less	5 mΩ or less	
	Insulation resistance	1000 MΩ or more	100 MΩ or more	1000 MΩ or more	100 MΩ or more	
	Withstand voltage	1.5 kV	1.0 kV	1.5 kV	1.0 kV	
	Ambient temperature	Connector	-25 to +60°C	-40 to +80°C	-25 to +60°C	-40 to +80°C
		Cable	-25 to +60°C	-40 to +80°C	-25 to +60°C	-40 to +80°C
	Min. bending radius (Fixed)	40 mm	21.7 mm	40 mm	21.7 mm	
Protection class	IP67 (Only with screw tightened)					
Allowable repeated insertion/withdrawal	200					
Material	Material of knurl	Brass (Nickel plating)	Zinc die-cast (Nickel plating)	Brass (Nickel plating)	Zinc die-cast (Nickel plating)	
	Contact (Surface treatment)	Phosphor bronze (Au plating)	CuSn (Au plating)	Phosphor bronze (Au plating)	CuSn (Au plating)	
	Connector material	Soft PBT (UL94 V0)	TPU (UL94 HB)	Soft PBT (UL94 V0)	TPU (UL94 HB)	
	Material of sheath (Sheath color)	PVC (Light gray)	PUR (Black-Gray (RAL 7021 equiv.))	PVC (Light gray)	PUR (Black-Gray (RAL 7021 equiv.))	
Weight	1 m: Approx. 80 g 5 m: Approx. 395 g	1 m: Approx. 85 g 5 m: Approx. 400 g	1.5 m: Approx. 65 g 3 m: Approx. 130 g 5 m: Approx. 195 g	1 m: Approx. 85 g 3 m: Approx. 215 g 5 m: Approx. 345 g	1.5 m: Approx. 65 g 3 m: Approx. 130 g 5 m: Approx. 195 g	

### Power Supply Cable

For PROFIBUS DP    For DeviceNet®    For EtherCAT    For PROFINET    For EtherNet/IP™

②⑥②⑦ EX500-AP 050 - S

Cable length (L)	
010	1000 mm
050	5000 mm

Connector specification	
S	Straight
A	Angle

#### Straight connector type

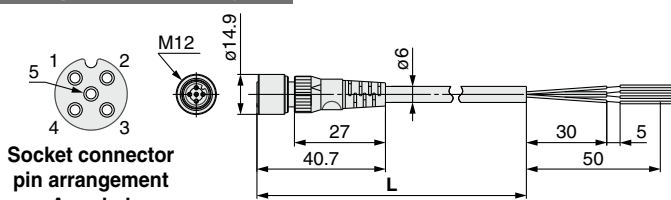

Socket connector pin arrangement  
A-coded  
(Normal key)

Item	Specifications
Cable O.D.	ø6 mm
Conductor nominal cross section	0.3 mm <sup>2</sup> /AWG22
Wire O.D. (Including insulator)	1.5 mm
Min. bending radius (Fixed)	40 mm

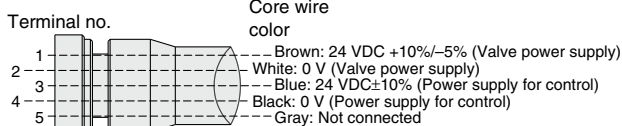

Connections (PROFIBUS DP/EtherCAT/PROFINET)

#### Angle connector type

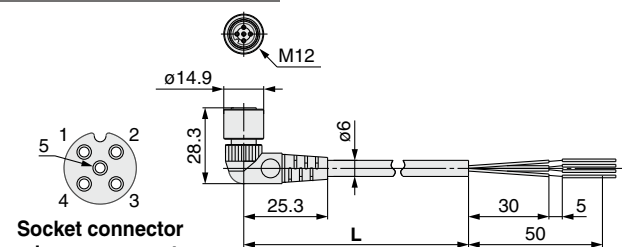

Socket connector pin arrangement  
A-coded  
(Normal key)

Item	Specifications
Cable O.D.	ø6 mm
Conductor nominal cross section	0.3 mm <sup>2</sup> /AWG22
Wire O.D. (Including insulator)	1.5 mm
Min. bending radius (Fixed)	40 mm

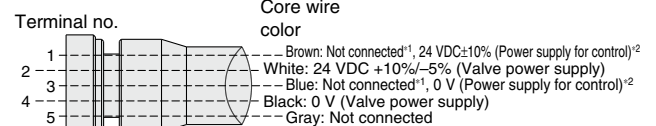

Connections (DeviceNet®, EtherNet/IP™)

\*1 For DeviceNet®  
\*2 For EtherNet/IP™



Made to Order

Cable length	10000 mm	p. 247
--------------	----------	--------

## Power Supply Cable

For PROFIBUS DP For DeviceNet® For EtherCAT For PROFINET For EtherNet/IP™

### 23 PCA-1401804

#### • Cable length (L)

1401804	1500 mm
1401805	3000 mm
1401806	5000 mm

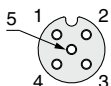

Socket connector pin arrangement A-coded (Normal key)

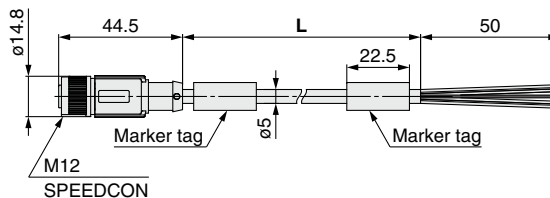

Item	Specifications
Cable O.D.	ø5 mm
Conductor nominal cross section	0.34 mm <sup>2</sup> /AWG22
Wire O.D. (Including insulator)	1.27 mm
Min. bending radius (Fixed)	21.7 mm

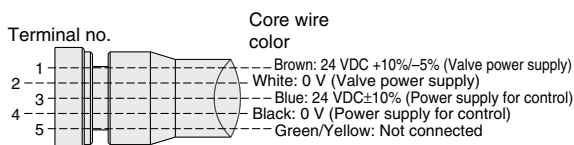

Connections (PROFIBUS DP/EtherCAT/PROFINET)

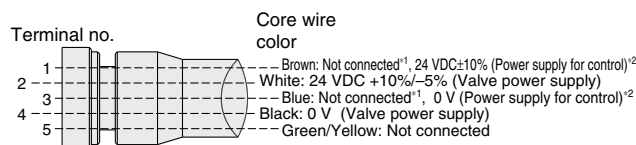

Connections (DeviceNet®, EtherNet/IP™)

\*1 For DeviceNet®  
\*2 For EtherNet/IP™

### For CC-Link

#### Straight connector type

### 29 EX9-AC 050-1

#### • Cable length (L)

010	1000 mm
030	3000 mm
050	5000 mm

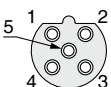

Socket connector pin arrangement B-coded (Reverse key)

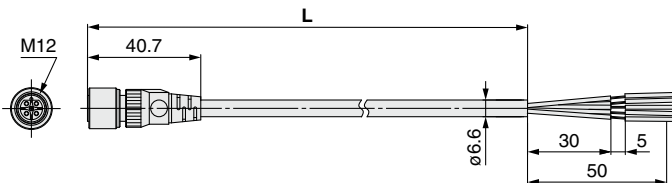

Item	Specifications
Cable O.D.	ø6.6 mm
Conductor nominal cross section	0.3 mm <sup>2</sup> /AWG22
Wire O.D. (Including insulator)	1.65 mm
Min. bending radius (Fixed)	40 mm

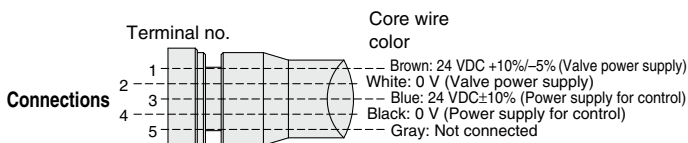

Connections



Made to Order

Cable length	10000 mm	p. 247
--------------	----------	--------

### 30 PCA-1401807

#### • Cable length (L)

1401807	1500 mm
1401808	3000 mm
1401809	5000 mm

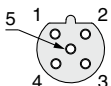

Socket connector pin arrangement B-coded (Reverse key)

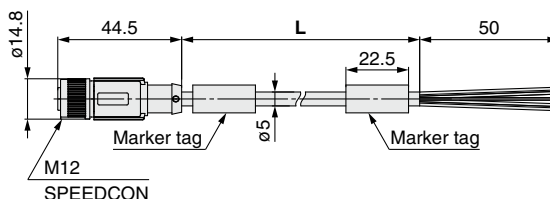

Item	Specifications
Cable O.D.	ø5 mm
Conductor nominal cross section	0.34 mm <sup>2</sup> /AWG22
Wire O.D. (Including insulator)	1.27 mm
Min. bending radius (Fixed)	21.7 mm

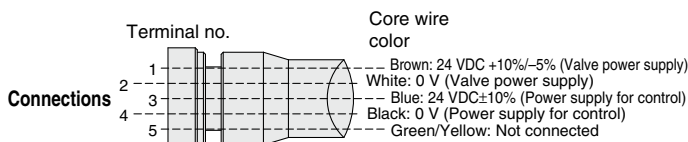

Connections

Type 1	EX260
Type 2	EX123/124/126
Type 2	EX500
Type 2	EX600
Type 3	EX245
Type 3	EX250
Type 1	EX120/121/122
Type 1	EX140
Type 1	EX180
Type 1	EX180
Type 2	EX510
Type 2	M8/M12
Type 2	ATEX

# Power Supply Cable

## EX250 Series

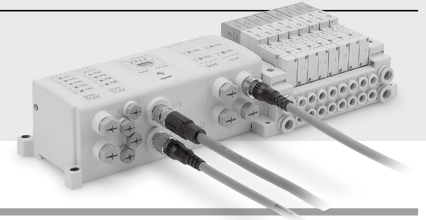

### Specifications

Description		Power supply cable (With connector on one side)		
Part no. (Cable length)		<b>EX9-AC010-1 (1 m)</b> <b>29 EX9-AC030-1 (3 m)</b> <b>EX9-AC050-1 (5 m)</b>	<b>26 EX500-AP010-S (1 m)</b> <b>EX500-AP050-S (5 m)</b>	
Protocol		CC-Link, DeviceNet®, CANopen	PROFIBUS DP, EtherNet/IP™	
Number of functional poles		M12: 5 pins	M12: 5 pins	
Key type		B-coded	A-coded	
Wiring	Cable O.D.	6.6 mm	6 mm	
	Conductor nominal cross section	0.3 mm <sup>2</sup> /AWG22	0.3 mm <sup>2</sup> /AWG22	
	Wire O.D. (Including insulating material)	1.65 mm	1.5 mm	
Rating/Performance	Rated current	3.1 A	3 A	
	Rated voltage	125 V		
	Contact resistance	40 mΩ or less		
	Insulation resistance	1000 MΩ or more		
	Withstand voltage	1.5 kV		
	Ambient temperature	Connector	-25 to +60°C	
		Cable	-25 to +60°C	
	Min. bending radius (Fixed)	40 mm		
	Protection class	IP67 (Only with screw tightened)		
	Allowable repeated insertion/withdrawal	200		
Material	Material of knurl	Brass (Nickel plating)		
	Contact (Surface treatment)	Phosphor bronze (Au plating)		
	Connector material	Soft PBT (UL94 V0)		
	Material of sheath (Sheath color)	PVC (Light gray)		
Weight		1 m: Approx. 85 g 3 m: Approx. 215 g 5 m: Approx. 345 g	1 m: Approx. 80 g 5 m: Approx. 395 g	

## Power Supply Cable

For CC-Link For DeviceNet® For CANopen

Straight connector type

### 29 EX9-AC 050 - 1

Cable length (L)

010	1000 mm
030	3000 mm
050	5000 mm

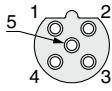

Socket connector pin arrangement  
B-coded  
(Reverse key)

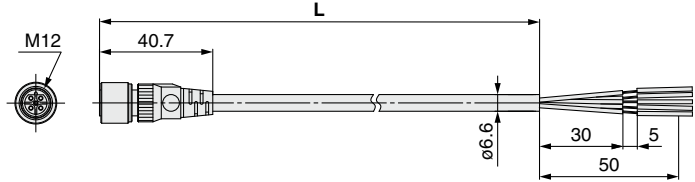

Item	Specifications
Cable O.D.	ø6.6 mm
Conductor nominal cross section	0.3 mm <sup>2</sup> /AWG22
Wire O.D. (including insulator)	1.65 mm
Min. bending radius (Fixed)	40 mm



Made to Order

Cable length	10000 mm	p. 247
--------------	----------	--------

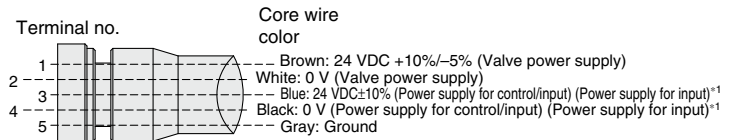

Connections

\*1 For DeviceNet® and CANopen

For PROFIBUS DP For EtherNet/IP™

Straight connector type

### 26 EX500-AP 050 - S

Cable length (L)

010	1000 mm
050	5000 mm

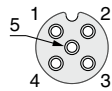

Socket connector pin arrangement  
A-coded  
(Normal key)

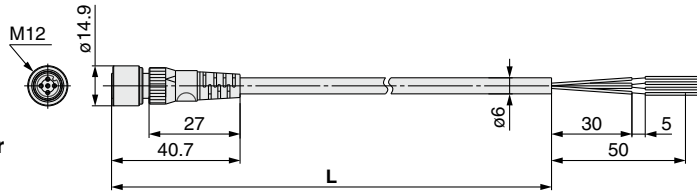

Item	Specifications
Cable O.D.	ø6 mm
Conductor nominal cross section	0.3 mm <sup>2</sup> /AWG22
Wire O.D. (including insulator)	1.5 mm
Min. bending radius (Fixed)	40 mm

Connector specification

S	Straight
---	----------



Made to Order

Cable length	10000 mm	p. 247
--------------	----------	--------

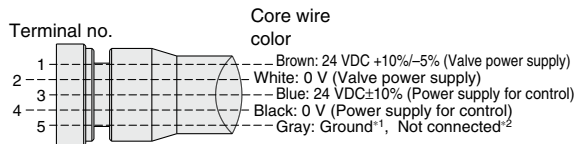

Connections (PROFIBUS DP, EtherNet/IP™)



\*1 For PROFIBUS DP  
\*2 For EtherNet/IP™

Type 1	EX260
Type 2	EX500
Type 3	EX600
Type 1	EX245
Type 1	EX250
Type 1	EX120/121/122
Type 1	EX140
Type 1	EX180
Type 2	EX510
M8/M12	
ATEX	

# Accessory Between the Sensor/Switch and the Input Device

## Field-wireable Connector

### Specifications

Part no.		PCA-1557730	PCA-1557743	PCA-1557756
Product image/Pin assignment				
Number of functional poles		M8: 3 poles	M12: 4 poles	
Key type		—	A-coded (Normal key)	
Wiring*1	Applicable cable	Cable O.D.		3.0 to 5.0 mm
	Wire gauge (Stranded wire cross section)	Wire gauge (Stranded wire cross section)		0.14 to 0.25 mm <sup>2</sup> /AWG26 to 24 0.25 to 0.34 mm <sup>2</sup> /AWG24 to 22
	Core wire diameter (Including insulating material)	Core wire diameter (Including insulating material)		1.0 to 1.6 mm
Connection type		Piercecon® connection	QUICKON-ONE connection	
Rating/Performance	Rated current	4 A		
	Rated voltage	60 V	250 V	
	Contact resistance	5 mΩ or less		
	Insulation resistance	100 MΩ or more		
	Withstand voltage	1.0 kV	1.4 kV	
	Ambient temperature	-40 to +85°C	-25 to +80°C	
	Protection class	IP67 (Only with screw tightened)		
Material	Allowable repeated insertion/withdrawal	100	200	
	Allowable number of repeated connection between conductors of the same cross section	10		
	Material of knurl	Brass (Nickel plating)	Zinc die-cast (Nickel plating)	
Contact (Surface treatment)		CuZn (Au plating (Ni underplating))		
Connector material		PA66 (UL94 V0)		
Weight		Approx. 14 g	Approx. 13 g	Approx. 15 g

\*1 The shaded sections show the specifications for the applicable cable. Adaptation for the connector may vary on account of the conductor construction of the electric wire.

### Field-wireable

#### ① PCA-1557730

##### Field-wireable connector (M8)

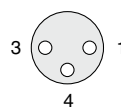
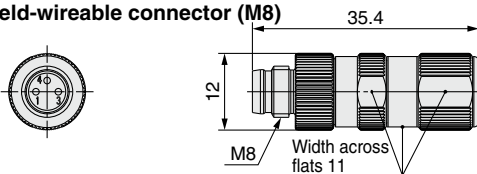

Plug connector pin assignment

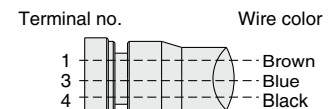

Wiring

#### ② PCA-1557743

##### Field-wireable connector (M12)

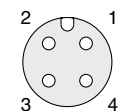
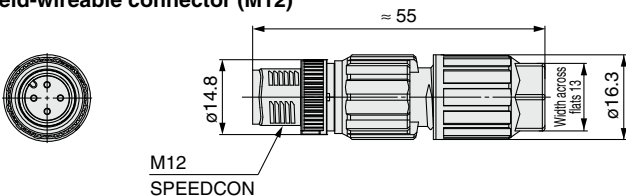

Plug connector pin assignment  
A-coded (Normal key)

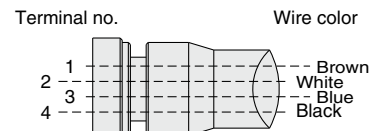

Wiring

#### ③ PCA-1557756

##### Field-wireable connector (M12)

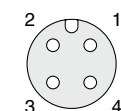
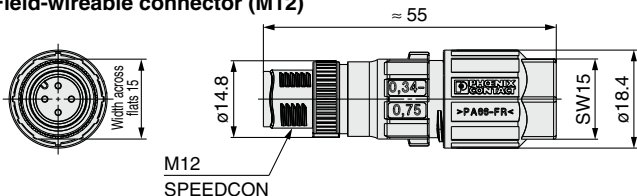

Plug connector pin assignment  
A-coded (Normal key)

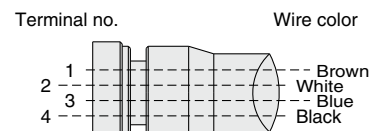



Wiring



# Accessory Between the Sensor/Switch and the Input Device

## Cable with Connector

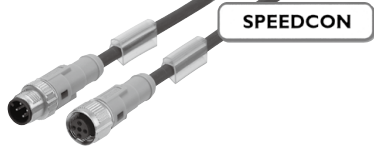
### Specifications

Part no.	PCA-1557769	PCA-1557772	
Product image	 <b>34 M12</b> 	 <b>35 M8</b> 	
Number of functional poles	M12: 4 poles	M8: 3 poles	
Key type	A-coded (Normal key)	—	
Wiring	Fixed cable length	3 m	
	Cable O.D.	4.7 mm	4.4 mm
	Conductor nominal cross section	0.34 mm <sup>2</sup> /AWG22	0.25 mm <sup>2</sup> /AWG24
	Min. bending radius (Fixed)	47 mm	44 mm
Rating/Performance	Rated current	4 A	
	Rated voltage	250 V	60 V
	Contact resistance	5 mΩ or less	
	Insulation resistance	100 MΩ or more	
	Withstand voltage	1.4 kV	1.0 kV
	Ambient temperature	Connector	-25 to +90°C
		Cable	-40 to +80°C
Material	Protection class	IP67 (Only with screw tightened)	
	Allowable repeated insertion/withdrawal	200	
	Material of knurl	Zinc die-cast (Nickel plating)	
	Contact (Surface treatment)	CuSn (Au plating (Ni underplating))	
	Connector material	TPU (UL94 HB)	
Material of sheath (Sheath color)	PUR (Black-Gray (RAL 7021 equivalent))		
Weight	Approx. 111 g	Approx. 80 g	

### Cable with Connector

#### 34 PCA-1557769 Cable with M12 connector (4 poles)

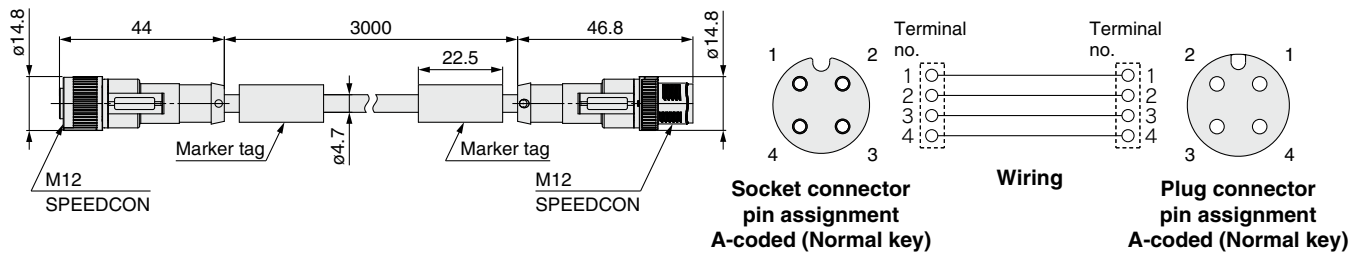

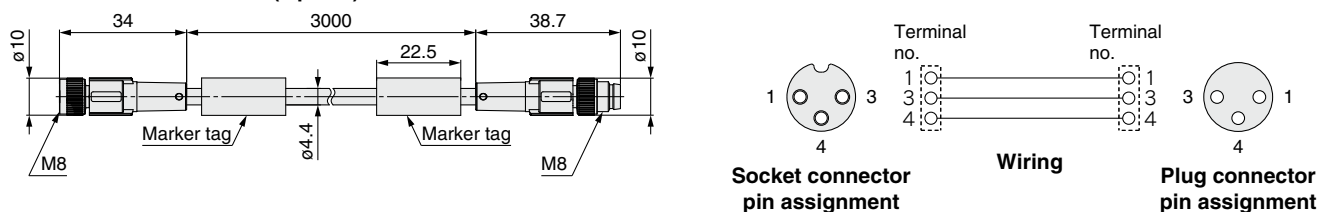

#### 35 PCA-1557772 Cable with M8 connector (3 poles)



# Accessory Between the Sensor/Switch and the Input Device

## Y Connector

### Specifications

Part no.	PCA-1557785	PCA-1557798
Product image		
Number of functional poles	2 x M12: 5 poles – M12: 5 poles	2 x M8: 3 poles – M12: 4 poles
Key type	A-coded (Normal key)	
Rating/Performance	Rated current	4 A
	Rated voltage	60 V
	Contact resistance	5 mΩ or less
	Insulation resistance	100 MΩ or more
	Withstand voltage	1.0 kV
	Ambient temperature	-25 to +90°C
	Protection class	IP67 (Only with screw tightened)
Allowable repeated insertion/withdrawal	200	
Material	Material of knurl	Zinc die-cast (Nickel plating)
	Contact (Surface treatment)	CuZn (Au plating (Ni underplating))
	Connector material	TPU (UL94 HB)
Weight	Approx. 29 g	Approx. 13 g

### Y Connector

**36** PCA-1557785  
Y connector  
(2 x M12-M12)

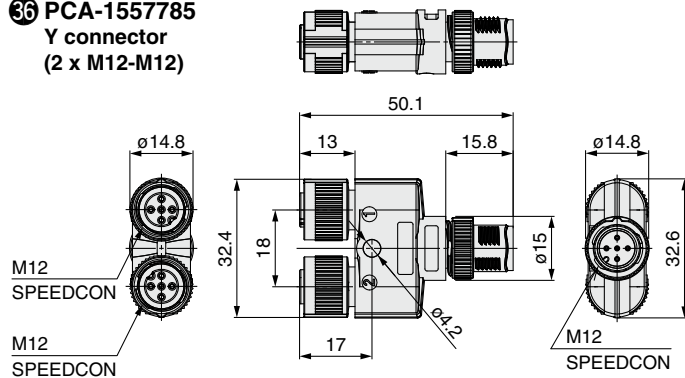

Socket connector  
pin assignment  
A-coded (Normal key)

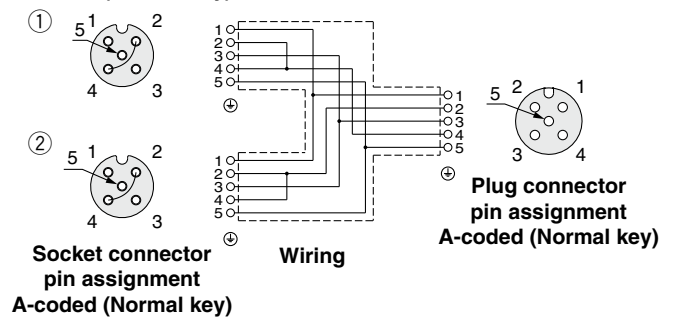

**37** PCA-1557798  
Y connector  
(2 x M8-M12)

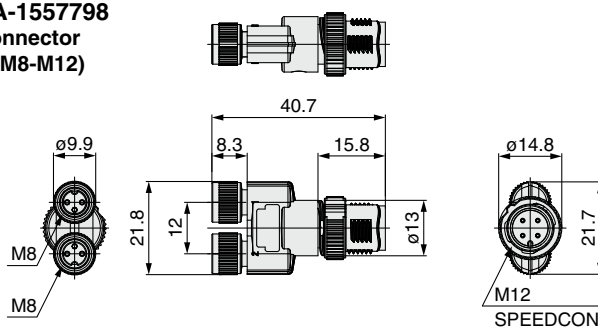

Socket connector  
pin assignment

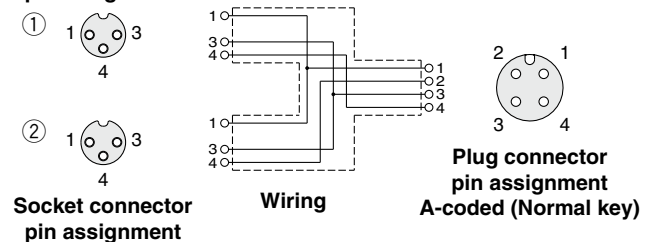

# EX9/EX500 Series Other Accessories

## A Power Cable with Connector (For power block)

### Straight connector type

EX9-AC **050** -1

• Cable length (L)

<b>010</b>	1000 mm
<b>030</b>	3000 mm
<b>050</b>	5000 mm

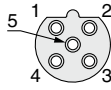

Socket connector  
pin arrangement  
B-coded  
(Reverse key)

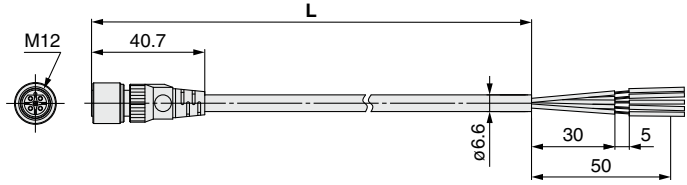

Item	Specifications
<b>Cable O.D.</b>	ø6.6 mm
<b>Conductor nominal cross section</b>	0.3 mm <sup>2</sup> /AWG22
<b>Wire O.D. (Including insulator)</b>	1.65 mm
<b>Min. bending radius (Fixed)</b>	40 mm



Made to Order

Cable length	10000 mm	p. 247
--------------	----------	--------

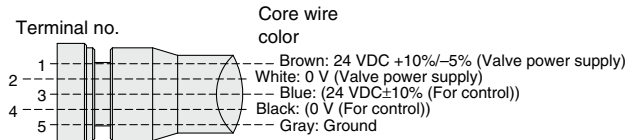

Connections

## B Cable with M12 Connector

EX500-AC **030** - **SSPS**

• Cable length (L)

<b>003</b>	300 mm
<b>005</b>	500 mm
<b>010</b>	1000 mm
<b>030</b>	3000 mm
<b>050</b>	5000 mm
<b>100</b>	10000 mm

• Connector specification

<b>SSPS</b>	Socket side: Straight, Plug side: Straight
<b>SAPA</b>	Socket side: Angle, Plug side: Angle

### Straight connector type

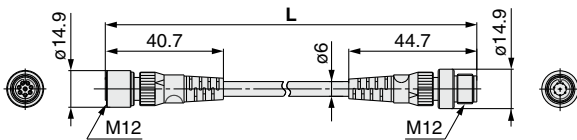

**A-coded**

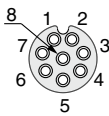

Socket  
pin arrangement

Terminal no.

1	White
2	Brown
3	Green
4	Yellow
5	Gray
6	Pink
7	Blue
8	Shield

Connections

**A-coded**

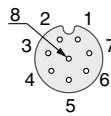

Plug  
pin arrangement

### Angle connector type

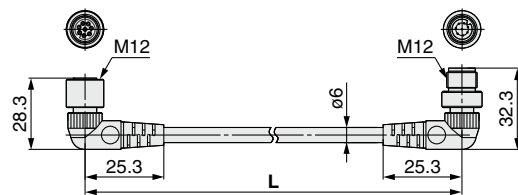

**A-coded**

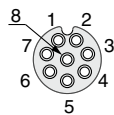

Socket  
pin arrangement

Terminal no.

1	White
2	Brown
3	Green
4	Yellow
5	Gray
6	Pink
7	Blue
8	Shield

Connections

**A-coded**

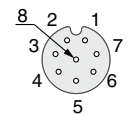

Plug  
pin arrangement

Item	Specifications
<b>Cable O.D.</b>	ø6 mm
<b>Conductor nominal cross section</b>	0.25 mm <sup>2</sup>
<b>Wire O.D. (Including insulator)</b>	1.27 mm
<b>Min. bending radius (Fixed)</b>	40 mm

Type 1	EX260
Type 2	EX500
Type 3	EX600
Type 1	EX245
Type 2	EX250
Type 1	EX120/121/122
Type 1	EX140
Type 1	EX180
Type 2	EX510
M8/M12	
ATEX	

# Other Accessories

## Terminal Plug

This is used in place of an input unit manifold (input unit/input block).  
(If a terminal plug is not used, the GW unit's COM LED will not light up.)

### EX500-AC000-S

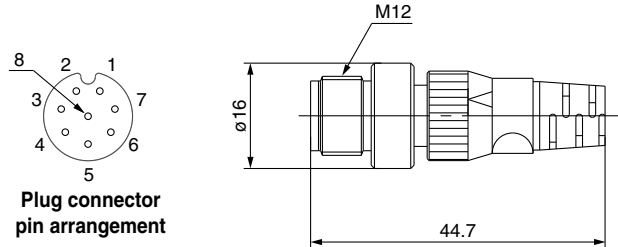

## Cable with Connector for Output Entry

Connects the output block to the output device

### Straight connector type

### EX9-AC 030 -7

• Cable length (L)

010	1000 mm
030	3000 mm

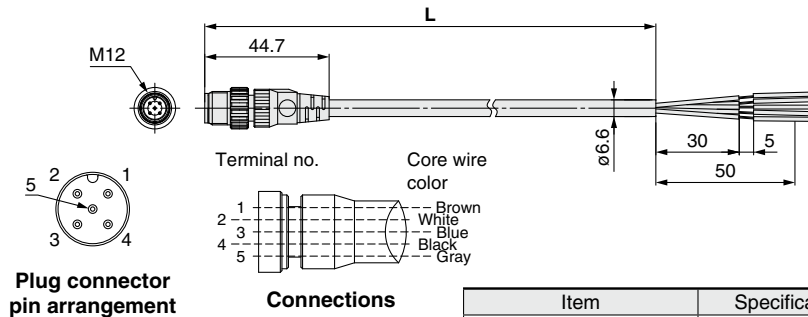

Item	Specifications
Cable O.D.	ø6.6 mm
Conductor nominal cross section	0.3 mm <sup>2</sup> /AWG22
Wire O.D. (Including insulator)	1.65 mm
Min. bending radius (Fixed)	40 mm

## Seal Cap: M12 Connector (For plug)

Use this on ports that are not being used for an M12 connector (plug).  
Use of this seal cap maintains the integrity of the enclosure.

\* Tighten the seal caps with the prescribed tightening torque. (For M12: 0.1 N·m)

### EX500-AWTP

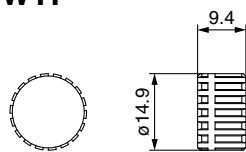

## Seal Cap: M8, M12 Connector (For socket)

Use this on ports that are not being used for an M8 or M12 connector (socket). Use of this seal cap maintains the integrity of the enclosure.  
(Seal caps are packed together with each unit.)

\* Tighten the seal caps with the prescribed tightening torque. (For M8: 0.05 N·m, For M12: 0.1 N·m)

### EX9-AW ES

• Connector type

ES	M8 connector (For socket), 10 pcs.
TS	M12 connector (For socket), 10 pcs.

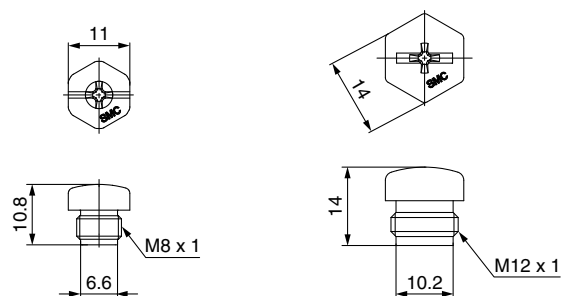

For M8 connector socket

For M12 connector socket

**Power Supply Cable (For connecting the SI unit to the power block)**

Connects between the power supply connector for the power block and the SI unit power supply connector, bridging the external power supply, which is supplied with the power block, to the SI unit.

**Straight connector type**

**EX9-AC002-2**

SI unit type

2	EX250-SDN1 EX250-SMJ2 EX250-SCA1A	Compliant
3	EX250-SPR1 EX250-SEN1	
4	EX250-SAS3/5	Compliant

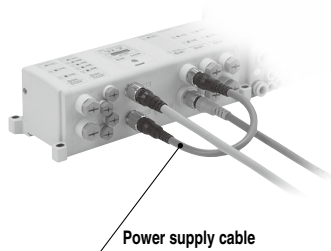

**EX9-AC002-2**

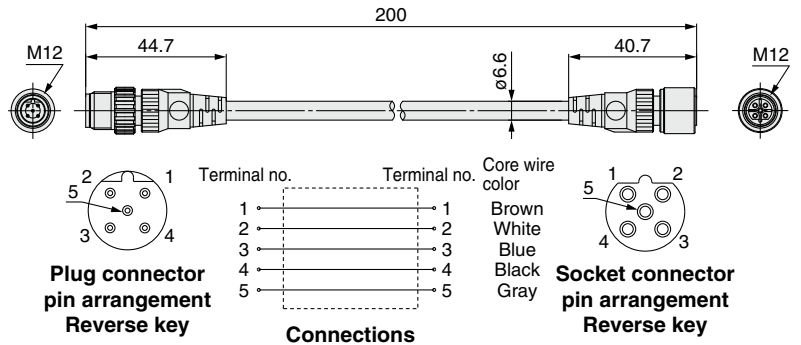

**EX9-AC002-3**

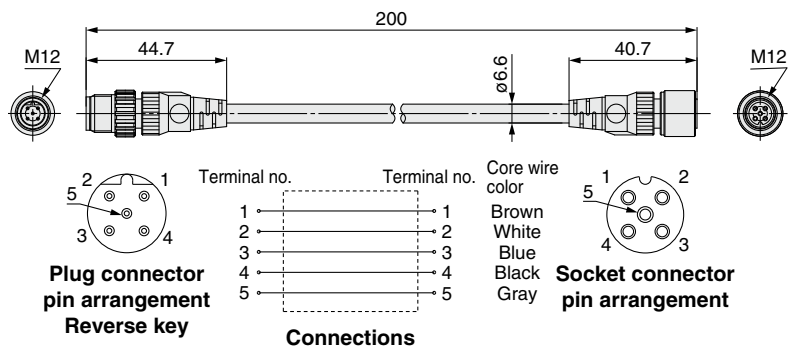

**EX9-AC002-4**

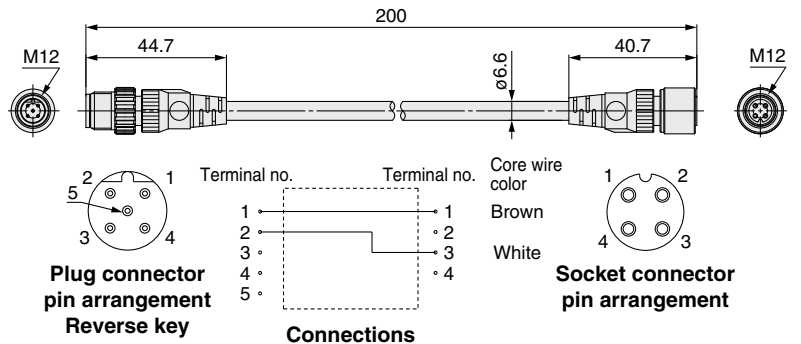

Item	Specifications
Cable O.D.	ø6.6 mm
Conductor nominal cross section	0.3 mm <sup>2</sup> /AWG22
Wire O.D. (Including insulator)	1.65 mm
Min. bending radius (Fixed)	40 mm

**AS-Interface Power Supply Cable**

Cable connecting between AS-Interface power supply line (for external devices) branch connector (M12) and the power block's power supply input connector.

**Straight connector type**

**EX9-AC 010 -5**

Cable length (L)

010	1000 mm
030	3000 mm
050	5000 mm

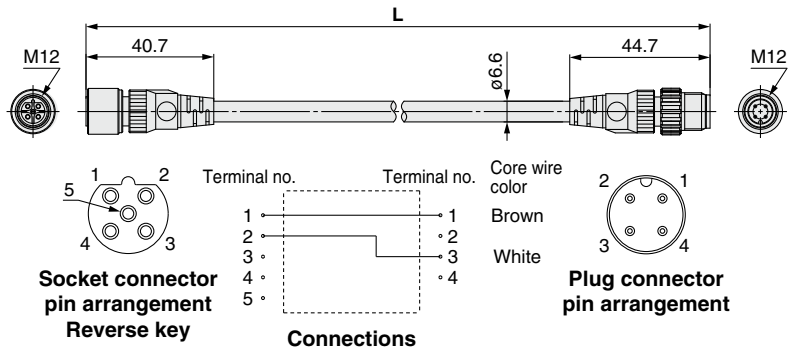

Item	Specifications
Cable O.D.	ø6.6 mm
Conductor nominal cross section	0.3 mm <sup>2</sup> /AWG22
Wire O.D. (Including insulator)	1.65 mm
Min. bending radius (Fixed)	40 mm

Type 1	EX260
Type 1	EX123/124/126
Type 2	EX500
Type 3	EX600
Type 3	EX245
Type 3	EX250
Type 1	EX120/121/122
Type 1	EX140
Type 1	EX180
Type 2	EX510
M8/M12	
ATEX	





**Communication Cable**

With connector on one side (Socket)

Cable length: 10000 mm

For CC-Link For DeviceNet®

EX9-AC100 **MJ** -X12

• Applicable protocol

<b>MJ</b>	CC-Link
<b>DN</b>	DeviceNet®

**Dimensions**

For CC-Link

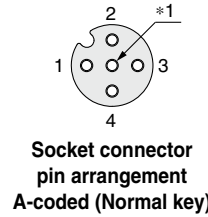
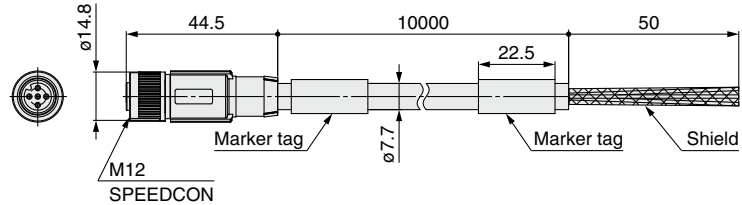

**Connections**

Terminal no.	Core wire color: Signal name (CC-Link)
<b>1</b>	Shield: SLD
<b>2</b>	White: DB
<b>3</b>	Yellow: DG
<b>4</b>	Blue: DA

\*1 Number of holes: 5, Total number of pins: 4

Item	Specifications
<b>Cable O.D.</b>	ø7.7 mm
<b>Conductor nominal cross section</b>	Data pair 0.5 mm <sup>2</sup> /AWG20
	Drain 0.34 mm <sup>2</sup> /AWG22
<b>Wire O.D. (Including insulator)</b>	2.55 mm
<b>Min. bending radius (Fixed)</b>	77 mm

For DeviceNet®

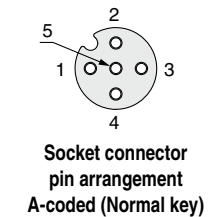
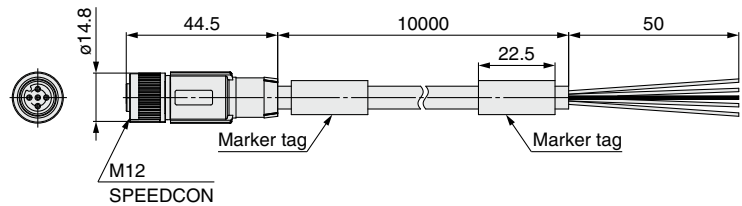

**Connections**

Terminal no.	Core wire color: Signal name (DeviceNet®)
<b>1</b>	Shield: DRAIN
<b>2</b>	Red: V+
<b>3</b>	Black: V-
<b>4</b>	White: CAN H
<b>5</b>	Blue: CAN L

Item	Specifications
<b>Cable O.D.</b>	ø6.7 mm
<b>Conductor nominal cross section</b>	Power pair 0.34 mm <sup>2</sup> /AWG22
	Data pair 0.25 mm <sup>2</sup> /AWG24
<b>Wire O.D. (Including insulator)</b>	Power pair 1.4 mm
	Data pair 2.05 mm
<b>Min. bending radius (Fixed)</b>	67 mm

- Type 1: EX260, EX123/124/126
- Type 2: EX500, EX600
- Type 3: EX245, EX250
- Type 1: EX120/121/122, EX140
- Type 2: EX180, EX510
- M8/M12
- ATEX

# Made to Order

## Power Supply Cable

### ① With connector on one side (Socket)

Cable length: 10000 mm

**For EX250/EX260/EX500**

**EX500-AP100-S-X1**

• Connector specification

<b>S</b>	Straight
<b>A</b>	Angle

#### Straight connector type

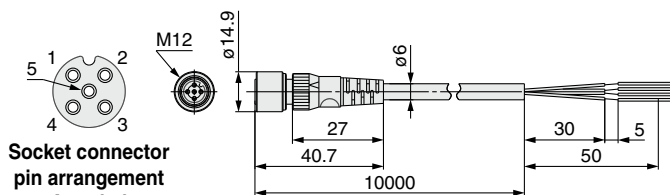

Socket connector pin arrangement A-coded (Normal key)

Item	Specifications
<b>Cable O.D.</b>	ø6 mm
<b>Conductor nominal cross section</b>	0.3 mm <sup>2</sup> /AWG22
<b>Wire O.D. (Including insulator)</b>	1.5 mm
<b>Min. bending radius (Fixed)</b>	40 mm

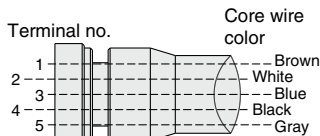

Connections

#### Angle connector type

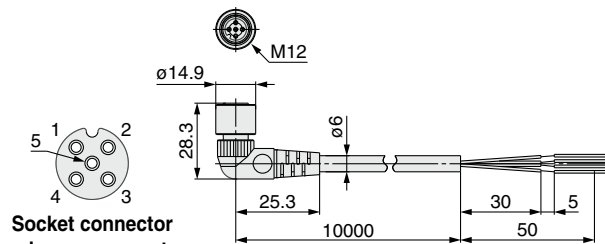

Socket connector pin arrangement A-coded (Normal key)

Item	Specifications
<b>Cable O.D.</b>	ø6 mm
<b>Conductor nominal cross section</b>	0.3 mm <sup>2</sup> /AWG22
<b>Wire O.D. (Including insulator)</b>	1.5 mm
<b>Min. bending radius (Fixed)</b>	40 mm

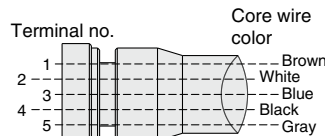

Connections

### ② With connector on one side (Socket)

Cable length: 10000 mm

**For EX250/EX260/EX9**

#### Straight connector type

**EX9-AC100-1-X16**

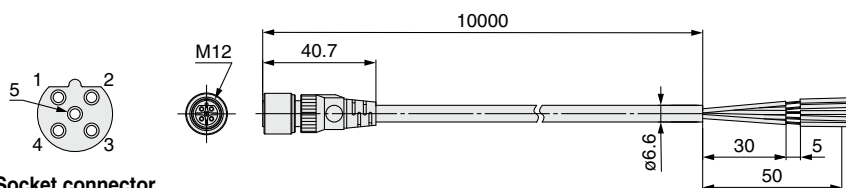

Socket connector pin arrangement B-coded (Reverse key)

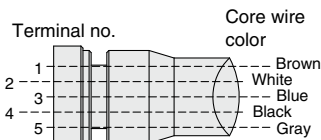

Connections

Item	Specifications
<b>Cable O.D.</b>	ø6.6 mm
<b>Conductor nominal cross section</b>	0.3 mm <sup>2</sup> /AWG22
<b>Wire O.D. (Including insulator)</b>	1.65 mm
<b>Min. bending radius (Fixed)</b>	40 mm



# PCA/EX9/EX500 Series

## Specific Product Precautions 1

Be sure to read this before handling the products. Refer to page 277 for safety instructions. For fieldbus system precautions, refer to pages 278 to 280 and the "Operation Manual" on the SMC website: <http://www.smcworld.com>

### Explanation of Terms

#### SPEEDCON

There are two types of cable with M12 connector: SPEEDCON compatible and non-compatible. If both plug and socket sides have connectors for SPEEDCON, the cable can be inserted and connected by rotating it 180°, leading to a reduction in labor hours. A non-compatible connector can be connected to a compatible connector as well as an M12.

#### Marker tag

By inserting the marked insertion label into the tag, the cable can be identified. For details of the insertion label, please make an inquiry to PHOENIX CONTACT.

· Part no.: 1013779 (PABA WH/23)

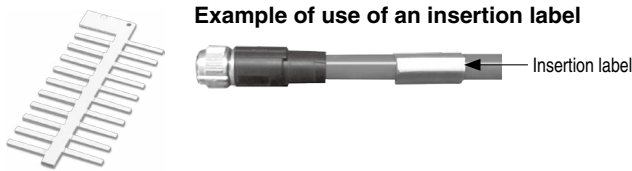

\* If an insertion label is not to be used, the marker tag can be removed before use.

### Wiring

#### ⚠ Caution

1. Do not lay the wires while they are energized. Doing so may give you an electric shock.
2. It should be cabled according to the connection diagram.
3. Check if it can be connected when using a sensor or switch.
4. When the cable sheath is stripped, confirm the stripping direction.

(For SMC switches with oblong cables)

The insulator may be split or damaged depending on the direction.

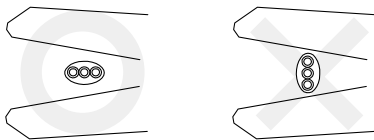

### Tightening of Screw

#### ⚠ Caution

1. The enclosure (IP65/67) cannot be maintained and the screws may become loose if they are not tightened sufficiently.
2. Check that they are tightened enough at appropriate intervals during operation.

### Connection and Disconnection of Connector

#### ⚠ Caution

1. Be sure to turn the power off when connecting and disconnecting the connectors.
2. Do not touch the engagement surface with wet hands.
3. Do not pull the cable out by holding the cable.
4. Note the key direction.

Especially for the SPEEDCON specification, match the protrusion of the knurl (bracket) and the mark at the mold for insertion so that the SPEEDCON function can be maintained.

5. When engaging the connectors, insert the connectors until the entire engagement surface is no longer visible and tighten the screws so as not to damage the thread ridges.

### Handling of Cable with Connector

#### ⚠ Caution

1. Avoid repeatedly bending or stretching the cable and applying heavy objects or force to it.
2. Set up the cables in a place where they will not be stepped on in order to prevent them from being broken and to prevent damage to the connectors. Install a protective cover when deemed necessary.
3. Do not pull the connector or cable unnecessarily. It may damage the connectors or break the cables.
4. Do not bend the cable at the root of the connector when installed.

### Handling of Field-wireable Connector

#### ⚠ Caution

##### Common Precautions

1. Follow the "Assembly Procedure" provided by SMC. If it is not followed correctly, it may not maintain IP65/67.
2. Do not use it for any purpose other than its original purpose.
3. This connector may only be operated when under no load.
4. Working with wet hands may lead to an electric shock.
5. Never attempt to repair the product yourself.

##### Spring-cage Connection

1. Do not use it for any purpose other than its original purpose.
2. This connector may only be operated when under no load.
3. Working with wet hands may lead to an electric shock.
4. Never attempt to repair the product yourself.

Type 1	EX260
Type 2	EX123/124/126
Type 2	EX500
Type 2	EX600
Type 3	EX245
Type 3	EX250
Type 3	EX120/121/122
Type 1	EX140
Type 1	EX180
Type 2	EX510
M8/M12	M8/M12
ATEX	ATEX



# PCA/EX9/EX500 Series

## Specific Product Precautions 2

Be sure to read this before handling the products. Refer to page 277 for safety instructions. For fieldbus system precautions, refer to pages 278 to 280 and the "Operation Manual" on the SMC website: <http://www.smcworld.com>

### Handling of Field-wireable Connector

#### **Caution**

##### QUICKON-ONE Connection

1. **Connection between cables** (with the same material and the same cross section) **is 10 times at max.**
2. **PVC or PE is suitable for sheath material, however fluoro resin is not suitable for sheath material.**
3. **Only for flexible cable, not for solid cable.**
4. **When you remove the cable, pull the cable. However, if you remove the cable gland, cable and the splice ring remain to the body.**

When you connect the cable again, screw the splice ring approx. two turns into the cable gland before using.

5. **When you connect the cable again, cut and strip the cable.**

##### Piercecon® Connection

1. **Connection between cables** (with the same material and the same cross section) **is 10 times at max.**
2. **Only for flexible cable, not for solid cable.**
3. **If you connect the cable again, cut and strip the cable.**

### Operating Environment

#### **Caution**

1. **Do not use in the atmosphere and environment over the rated specifications.**
2. **Do not use in the environment of corrosive gas or liquid splash.**
3. **Do not use in an environment where oil and chemicals are used.**

### Maintenance

#### **Caution**

1. **Perform periodic inspection.**