

Cylinder Speed Checker (Built-in Magnet Cylinder)



RoHS

3
measurement
modes

Speed (mm/s)

Time required for stroke (s)

Operation count (Times)

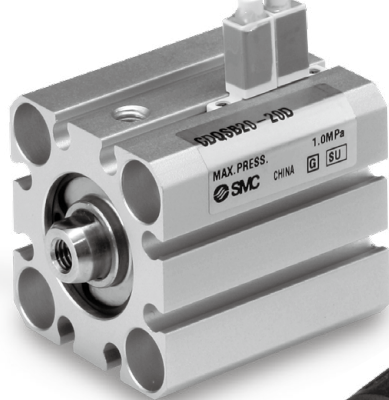

Realizes increase in efficiency with visualization of air cylinder operation.

- Quantification of cycle time improvements
- For reduction of numerical management/adjustment labor when starting up equipment
- For reduction of numerical confirmation/inspection labor during periodic maintenance

⚠ Caution The measurement may not be performed with an air gripper or rotary actuator, or the measurement deviation may increase. Please contact SMC for more information.

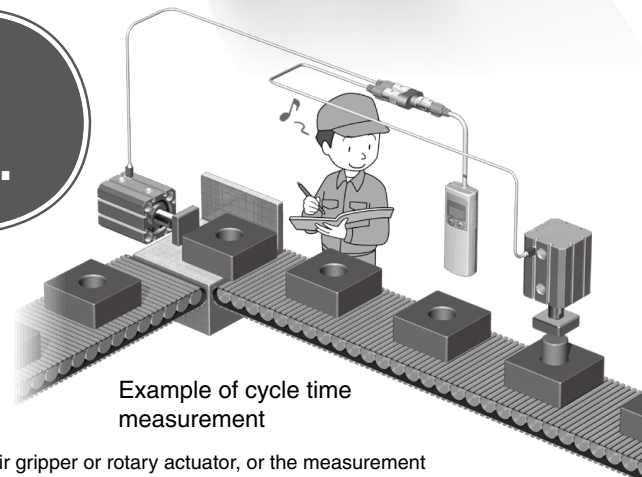

Example of cycle time measurement

IN574-95/-73



14-E641 ©

3 Measurement Modes

Speed (mm/s)

Measures the speed of cylinders.

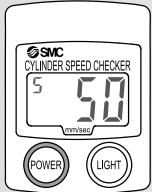

Rated measurement range
-1999 to 1999 mm/s

Note) Minus (-) is added to the measured value to distinguish the extension and retraction of a cylinder.

Rod extension end: Positive direction
Rod retraction end: Reverse direction (-)

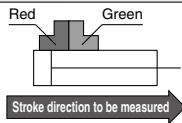

* Although a measurement can be done even when the sensor is mounted in the reverse direction, the display direction is also reversed.

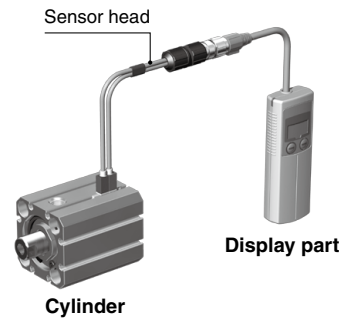
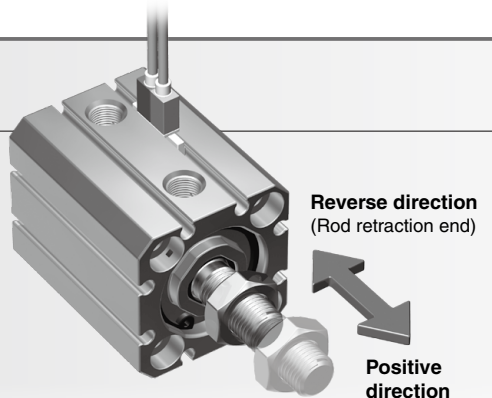

Time required for stroke (s)

Measures the time required for the stroke of the cylinder (rod retraction end to rod extension end).

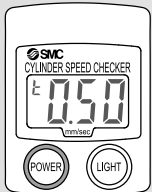

Rated measurement range
-999.9 to 999.9 s

Note) Minus (-) is added to the measured value to distinguish the extension and retraction of a cylinder.

Rod extension end: Positive direction
Rod retraction end: Reverse direction (-)

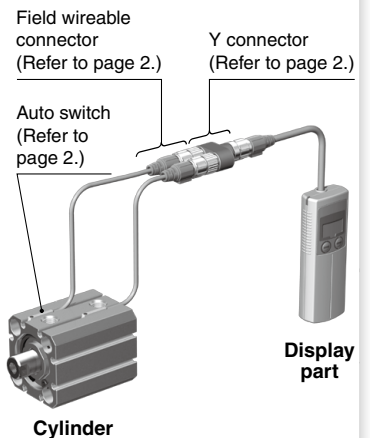
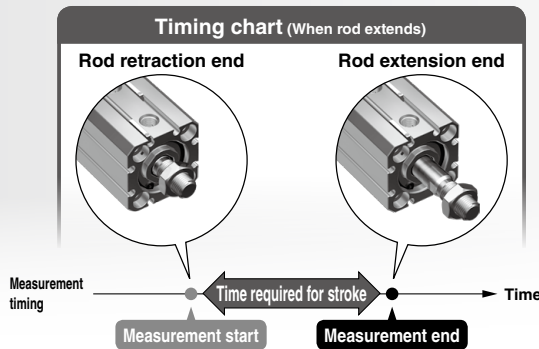

Operation count (Times)

Measures the operation count of a cylinder for 1 minute.

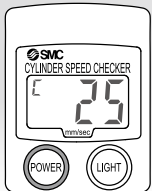

Rated measurement range
0 to 999 times

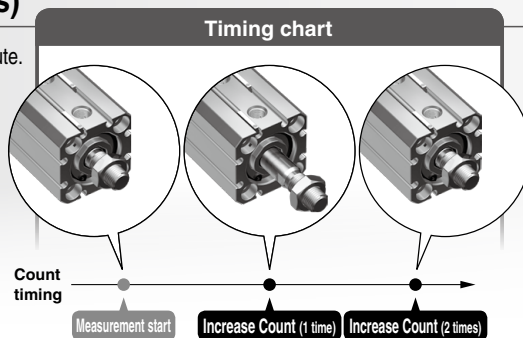

- Compact: 40 (Width) x 110 (Height) x 20 (Depth) mm
- Lightweight: Approx. 65 g (Body)/25 g (Sensor)
* Excluding dry cell batteries.
- Battery powered: 2A dry cell battery x 2,
continuous use for 15 hours or more.

- With backlight
- With auto power-off function*
* If a button is not operated for 15 min. or more,
the power supply will turn off automatically.



RoHS

Cylinder Speed Checker IN574-95/-73

How to Order

Sensor head + Display part **IN574-95**

Sensor head **IN574-73**



Speed Measurement Type

Model **IN574-95**

(① Sensor head + ② Display part)

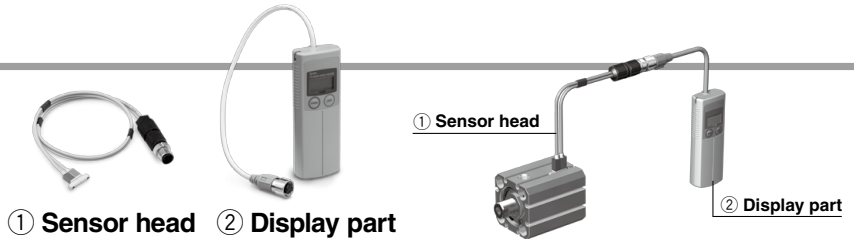

Time Required for Stroke/Operation Count Measurement Type

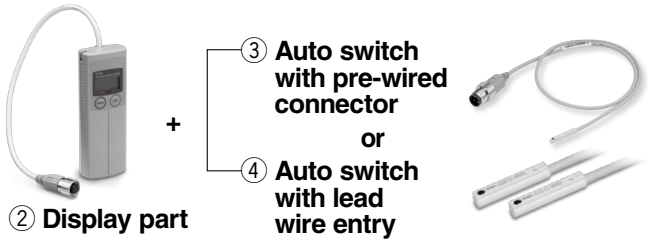

③ Auto switch with pre-wired connector

D-M9NSAPC

Applicable auto switch

Function	Electrical entry	Applicable model
—	Grommet (In-line)	M9N
	Grommet (Perpendicular)	M9NV
2-color indication	Grommet (In-line)	M9NW
	Grommet (Perpendicular)	M9NWV
Water resistant	Grommet (In-line)	M9NA
	Grommet (Perpendicular)	M9NAV

Connector model

A	M8-3 pin
D	M12-4 pin

Lead wire length

S	0.5 m
M	1.0 m

* Please contact SMC for other applicable auto switches.

④ Auto switch with lead wire entry

D-M9N

Applicable auto switch

Function	Electrical entry	Applicable model
—	Grommet (In-line)	M9N
	Grommet (Perpendicular)	M9NV
2-color indication	Grommet (In-line)	M9NW
	Grommet (Perpendicular)	M9NWV
Water resistant	Grommet (In-line)	M9NA
	Grommet (Perpendicular)	M9NAV

Lead wire length

Nil	0.5 m
M	1.0 m

* Please contact SMC for other applicable auto switches.

* The lead wire is converted to M8/M12 connector for use.

⚠ Order separately when using the time required for stroke/operation count measurement modes.

Application example

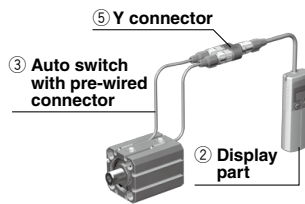

Ordering example

⑤ Y connector
③ Auto switch with pre-wired connector
② Display part

- **IN574-95**.....1 pc.
Cylinder Speed Checker (Sensor head + Display part)*
- **D-M9NSAPC**.....2 pcs.
Auto switch with pre-wired connector
- **PCA-1557798**.....1 pc.
Y connector

* The sensor is not used when the checker is used for the time required for stroke/operation count measurement.

Application example

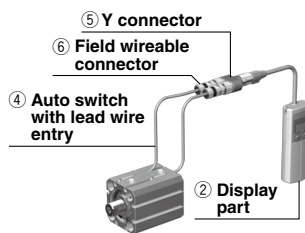

Ordering example

⑤ Y connector
⑥ Field wireable connector
④ Auto switch with lead wire entry
② Display part

- **IN574-95**.....1 pc.
Cylinder Speed Checker (Sensor head + Display part)*
- **D-M9N**.....2 pcs.
Auto switch with lead wire entry
- **PCA-1557730**.....2 pcs.
Field wireable connector
- **PCA-1557798**.....1 pc.
Y connector

* The sensor head is not used when the checker is used for the time required for stroke/operation count measurement.

⑤ Y connector

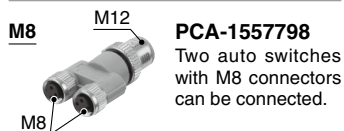

⑥ Field wireable connector



* Note that although it can be connected, the IP65/67 may not be held depending on the assembly method.

Refer to the **WEB catalog** for the details on the auto switches (③, ④) and the M8/M12 connectors (⑤, ⑥).

IN574-95/-73

Specifications Note 1)

Model		IN574-95	
Measurement mode	Speed	Time required for stroke	Operation count (Times)
Rated measurement range	-1999 to 1999 mm/s	-999.9 to 999.9 s	0 to 999 times
Minimum display unit	1 mm/s	0.01 s (0.00 to 99.99 s, 0.00 to -99.99 s) 0.1 s (100.0 to 999.9 s, -100.0 to -999.9 s)	1 time
Measurement accuracy	±20% or less	±0.2 s or less	—
Power supply <small>Note 2)</small>	2 x 1.5 VDC 2A alkali dry cell batteries (continuous use for 15 hours or more)		
Applicable cylinder	Built-in magnet		
Environmental resistance	Enclosure	IP40	
	Operating temperature range	Operating: 0 to 40°C, Stored: -10 to 60°C (with no freezing or condensation)	
	Operating humidity range	Operating/Stored: 35 to 85% R.H. (with no condensation)	
	Vibration resistance	10 to 150 Hz at 1.5 mm amplitude or 98 m/s ² acceleration whichever is smaller, in X, Y, Z directions for 2 hrs. each (De-energized)	
Impact resistance	100 m/s ² in X, Y, Z directions 3 times each (De-energized)		
Weight	Sensor part: 25 g, Body: 65 g (excluding dry cell batteries)		
Standards	RoHS, CE		

Note 1) The above specifications may change depending on the operating environment.

Note 2) 2A alkali dry cell batteries are not included, and must be acquired separately.

Speed Measurement Sensor/D-F8N

Power supply voltage	4.5 to 28 VDC
Current consumption	10 mA or less
Load voltage	28 VDC or less
Load current	40 mA or less
Internal voltage drop	1.5 V or less (0.8 V or less at 10 mA)
Leak current	100 µA or less
Operating time	1 ms or less
Indicator light	Red LED is illuminated when turned ON.
Ambient temperature	-10 to 60°C

Applicable Auto Switches for the Time Required for Stroke/ Operation Count Measurement

Power supply voltage	14 VDC or less
Output type	NPN open collector
ON voltage	2 V or less
OFF current	100 µA or less

Dimensions

IN574-95 (Sensor head + Display part)

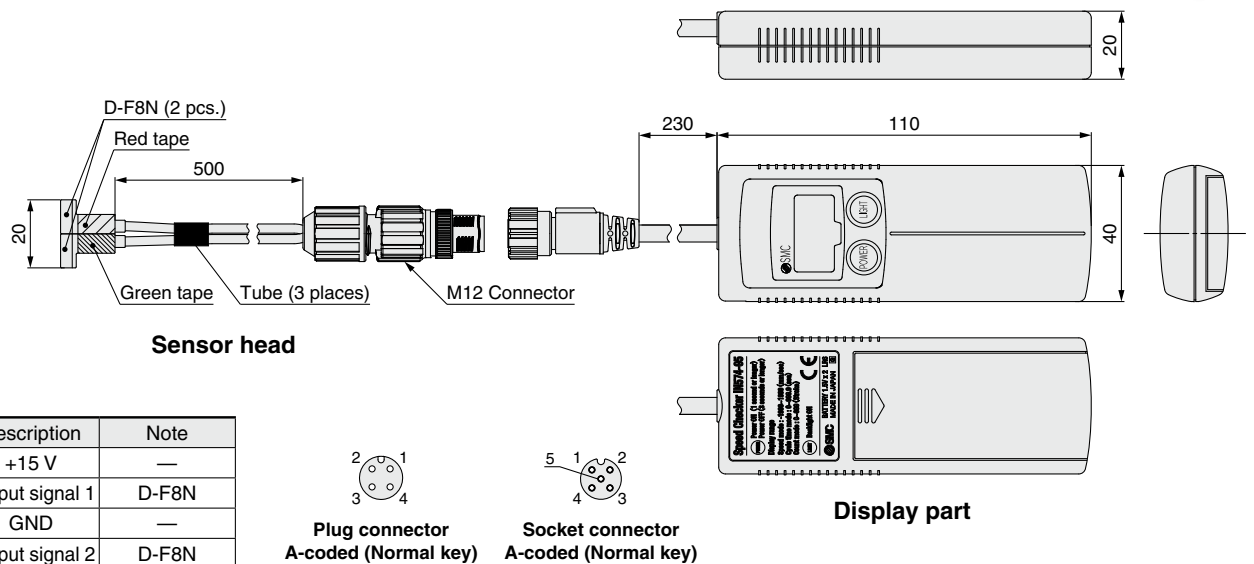

⚠ Safety Instructions Be sure to read the "Handling Precautions for SMC Products" (M-E03-3) and "Operation Manual" before use.