

GW System, 4 Branches

EX510 Series

Compatible communication network



GW unit

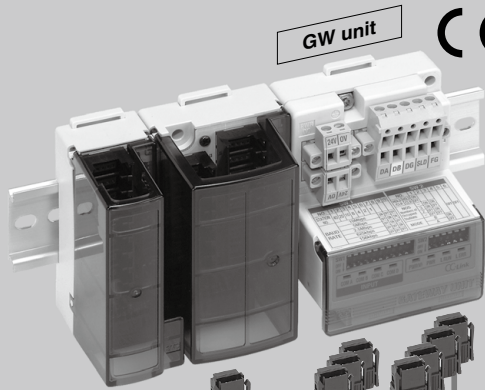

* Input units with covers

e-CON connectors

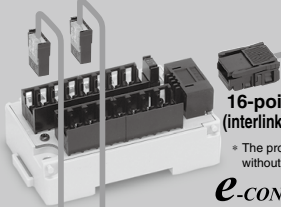

* The product is shown without a cover.

e-CON connectors

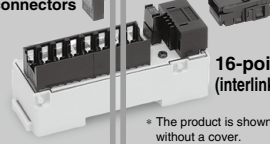

* The product is shown without a cover.



Pressure switch

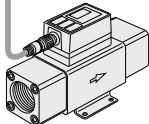

Flow switch

Input device

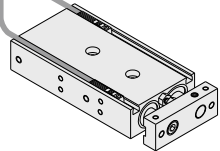

Auto switch

Two 2-wire auto switches can be connected to a single connector.

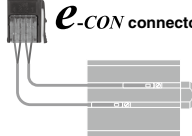

Including SI unit
manifold valve

VQZ1000/2000/3000



S0700



SY3000/5000/7000/9000

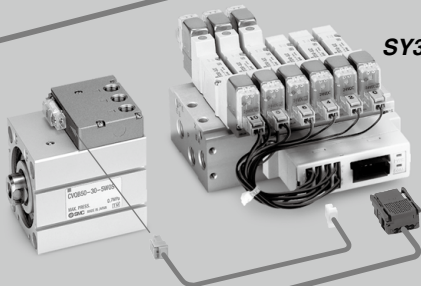

Output unit

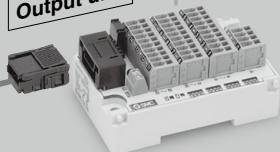

<p>SY3000/5000 (Plug-in)</p>	<p>S0700 (Plug-in)</p>
<p>SY3000/5000 (Plug-in)</p>	<p>SYJ3000/5000/7000</p>
<p>SJ2000/3000</p>	<p>SZ3000</p>
<p>SQ1000/2000</p>	<p>VQ1000/2000</p>

Note) SY, SYJ, SQ, SZ, S0700, VQ, VQZ are not yet UL-compatible.

Output equipment

Valve, indicator light, relay, buzzer, etc.
can be connected.

**2 port
solenoid valve**



EX12

EX140

EX180

EX260

EX250

EX600

EX500

EX510

PCA
EX

Features of EX510 series

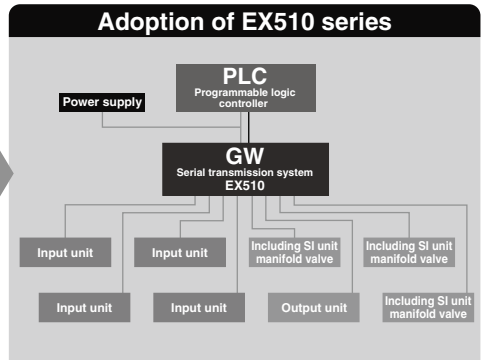
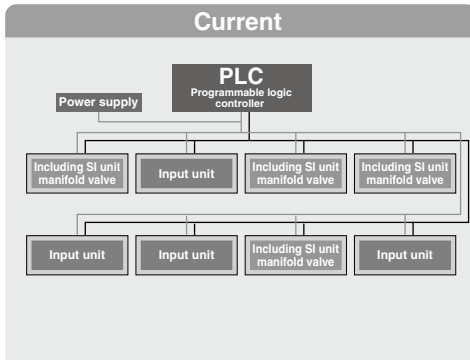

Feature 1 More valves and sensors can be connected.

- The introduction of the **EX510** series makes it possible to connect more valves and sensors.

Compatible protocol	Current SI unit model
CC-Link	3 master stations 3 manifold
DeviceNet™	1 node 1 manifold
PROFIBUS DP	1 node 1 manifold

Compatible protocol	EX510 series
CC-Link	3 master stations 4 manifold/4-input unit
DeviceNet™	1 node 4 manifold/4-input unit
PROFIBUS DP	1 node 4 manifold/4-input unit

Feature 2 Connector cables result in wire-savings. (including power supply cable)

- A power supply cable for each slave unit was required in the past.

- With the introduction of the **EX510** series, only a power supply cable to the GW unit is required.

Connected to each unit is a branch cable which combines the cables for communication and power supply.

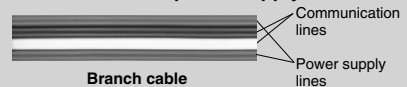

Feature 3 There is no need to set the address for the SI unit, output unit and input unit.

- Setting the address for each unit was required in the past.

- It is okay to set the address for the GW unit only.

Feature 4 Compact SI unit

- The SI unit which connects output devices such as a solenoid valve has a compact design, compared with a current model. (Compactness: volume ratio more than 60%)

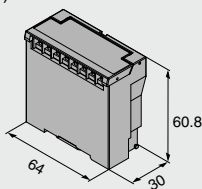

Current model (EX120 series)

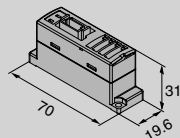

EX510 series

Feature 5 Can flexibly change to Field Bus.

- In the past, all the part numbers of slave units were needed to be changed by returning it to the manufacturer and reordering (re-estimate, delivery time) it.



- After the introduction of the EX510 series, only the GW unit needs to be changed.

Feature 6 Adoption of connectors which do not require any special tools for installation

No special tools are required for press-fitting the connectors for branch cable connections and the e-con connectors for sensor connections.

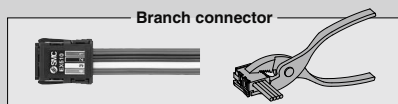

No need to strip the wire Only pliers are required for clamping.

The output unit adopts a spring type terminal box, eliminating the need to tighten any retaining screws.

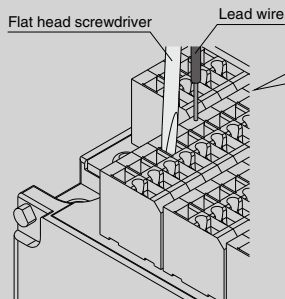

Torque control, crimping work is unnecessary.
Screwless construction. No tightening of retaining screws required.

EX12□

EX140

EX180

EX260

EX250

EX600

EX500

EX510

PCA
EX□

Feature 7 Cable length of up to 20 meters is available.

Various units can be connected within a radius of 20 meters around the GW unit.

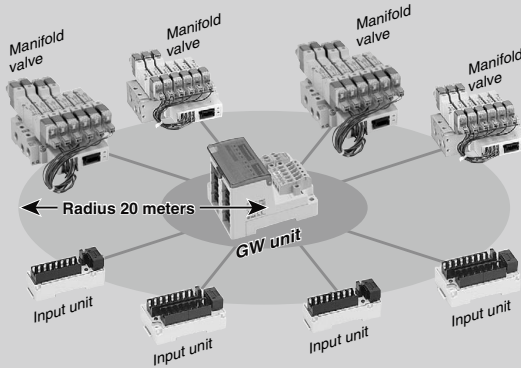

Feature 8 Delay in transmission of 1 ms or less

The delay in transmission between the GW unit and SI unit/Output unit/Input unit is 1 ms or less.

Feature 9 Making I/O flexible

The occupying number of points in the GW unit can be configured flexibly by setting a switch.

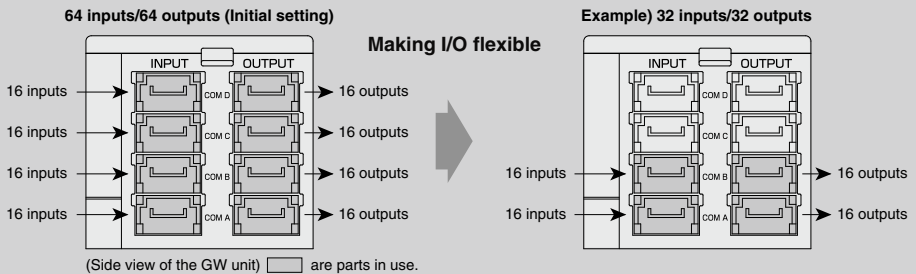

* Setting is different depending on the respective protocol. Refer to the specifications for details.

Feature 10 Effectively using the unused points of the SI unit

Valves which are independent from the manifold can be converted to serial transmission without purchasing new SI units.

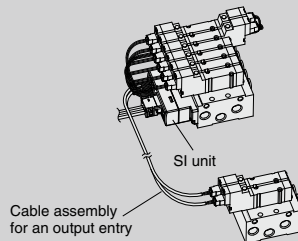

Feature **11** Protection

Each unit is protected against a short-circuit from a power supply load.

Input/Output unit fuses are replaceable.

The short circuit protection is integrated for the SI unit.

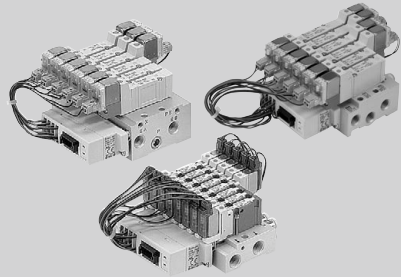
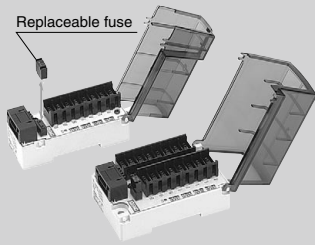

- EX12
- EX140
- EX180
- EX260
- EX250
- EX600
- EX500
- EX510**
- PCA
- EX

GW System, 4 Branches

EX510 Series



GW Unit

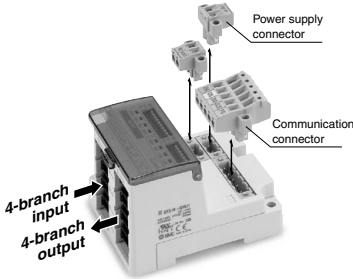

How to Order

EX510-G **MJ1**

Communication protocol

MJ1	CC-Link
DN1	DeviceNet™
PR1	PROFIBUS DP

Specifications

Model		EX510-GMJ1	EX510-GDN1	EX510-GPR1
Communication	Applicable system	CC-Link	DeviceNet™	PROFIBUS DP
	Protocol Version	Ver. 1.10	Release 2.0	DP-V0
	Communication speed	156 k/625 k/ 2.5 M/5 M/10 Mbps	125 k/250 k/ 500 kbps	9.6 k/19.2 k/45.45 k/ 93.75 k/187.5 k/500 k/ 1.5 M/3 M/6 M/12 Mbps
	Configuration file	—	EDS file	GSD file
	I/O occupation area (Inputs/Outputs)	96/96 <small>(3 stations, remote device station) * Possible to change depending on the switch setting</small>	64/64 * Possible to change depending on the switch setting	
Terminating resistor	Not provided		Provided	
Power supply voltage	For unit	24 VDC±10%	11 to 25 VDC <small>(Supplied by DeviceNet™ circuit, 50 mA or less)</small>	24 VDC±10%
	For sensors	24 VDC±10%		
	For valve	24 VDC±10%/-5%		
Internal current consumption	100 mA or less (single GW unit)			
Input	Number of inputs	64 inputs (16 inputs x 4 branches) * Possible to change depending on the switch setting		
	Connection input device	The EX510 series input unit (connection from communication port A to D)		
	Supply voltage	24 VDC		
	Supply current	Max. 4A (Max. 1 A per branch)		
Output	Number of outputs	64 outputs (16 outputs x 4 branches) * Possible to change depending on the switch setting		
	Connection output device	The EX510 series SI unit manifold and output unit (connection from communication port A to D)		
	Supply voltage	24 VDC		
	Supply current	Max. 6 A (Max. 1.5 A per branch)		
Branch cable length	20 m or less			
Environment	Enclosure	IP20		
	Operating temperature range	-10 to 50°C		
	Operating humidity range	35 to 85%RH (with no condensation)		
	Withstand voltage	500 VAC for 1 min. between whole external terminal and FG		
	Insulation resistance	10 MΩ or more (500 VDC) between whole external terminal and FG		
Standards	CE marking, UL (CSA)			
Weight	160 g (including accessory)			
Accessory	Communication connector 1 pc., Power supply connector 2 pcs.		Communication connector 1 pc., Power supply connector 2 pcs., Terminating resistor 1 pc.	

- Note 1) Please note that the version is subject to change.
 Note 2) Each file can be downloaded from SMC website (<http://www.smcworld.com>).
 Note 3) For detailed specifications other than the above, refer to the operation manual that can be downloaded from SMC website (<http://www.smcworld.com>).

Dimensions

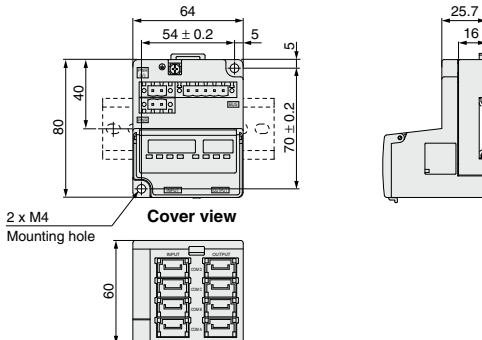

Parts Description

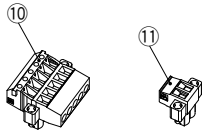
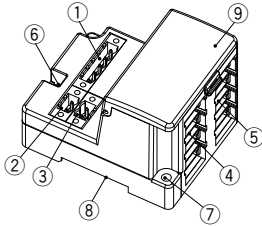

Communication connector (1 pc.)

Power supply connector (2 pcs.)

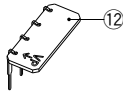

Terminating resistor (1 pc.)
* Attached to EX510-GPR1 only.

Accessories

GW Unit

No.	Description	Applications
1	Communication socket (BUS)	For connecting with a network, using the communication connector (10), which is part of the accessories.
2	Power supply socket (PWR(V))	Supplies power for output devices, which have a power supply connector (11), such as a solenoid valve.
3	Power supply socket (PWR)	Supplies power for input devices, which have a power supply connector (11), such as a sensor.
4	Branch connector (for input) on GW unit side	Connects input units, etc., using a branch cable (EX510-FC□□).
5	Branch connector (for output) on GW unit side	Connects the SI unit (manifold valves) etc., using the branch cable (EX510-FC□□).
6	FG terminal	Used for grounding.
7	Mounting hole	Used for mounting the unit with two M4 screws.
8	Mounting groove for DIN rail	Used for mounting the unit to a DIN rail.
9	Display, Switch setting part	Displays the LED corresponding to the unit's condition, address setting, and the communication speed for the switches.
10	Communication connector	Used for connecting the network cable.
11	Power supply connector	Used for connecting the power supply cable.
12	Terminating resistor	Connects the terminating resistor to both ends of a unit in the transmission line.

- EX12□
- EX140
- EX180
- EX260
- EX250
- EX600
- EX500
- EX510
- PCA
- EX□

Communication Connector Pin Assignment

Part no.	Communication protocol	Pin assignment and the corresponding wire color				
		①	②	③	④	⑤
EX510-GMJ1	CC-Link	DA (Blue)	DB (White)	DG (Yellow)	SLD	FG
EX510-GDN1	DeviceNet™	V- (Black)	CAN_L (Blue)	Drain	CAN_H (White)	V+ (Red)
EX510-GPR1	PROFIBUS DP	VP	RxD/TxD-N (Green)	DGND	RxD/TxD-P (Red)	SHIELD

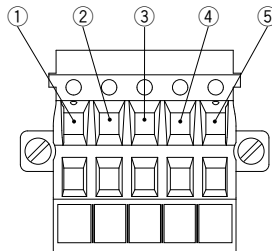

EX510 Series

EX510-GMJ1 (CC-Link compliant)

Display Setting

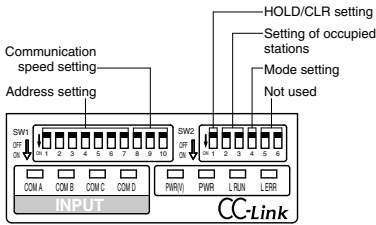

Display	Contents	Indicator light condition
PWR(V)	The output power supply voltage is supplied as specified. The output power supply voltage is not supplied as specified.	Light is turned on. Light is turned off.
PWR	When the input and the power for the Gateway is being supplied. When the input and the power for the Gateway is not being supplied.	Light is turned on. Light is turned off.
L RUN	When transmission is working properly. When transmission is interrupted.	Light is turned on. Light is turned off.
L ERR	When there is an error in the transmission. When setting the station number while being energized. When the transmission speed setting switch is changed. When the transmission is working properly.	Light is turned on. Light is turned on. (Blinks at 0.4 second intervals) Light is turned off.
COM A to D	When COM A to D are receiving data. When COM A to D are not receiving data.	Light is turned on.* Light is turned off.

* Input unit (Input device) is connected and will illuminate when communication is working properly.

Internal Circuit

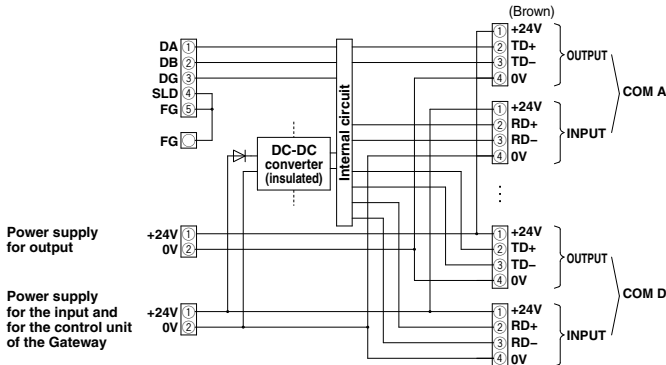

Flexible I/O Setting Examples

The occupying number of the Gateway units can be changed flexibly by setting a switch. (Side view of the Gateway unit)
Refer to the operation manual for details. (Grey areas are parts in use.)

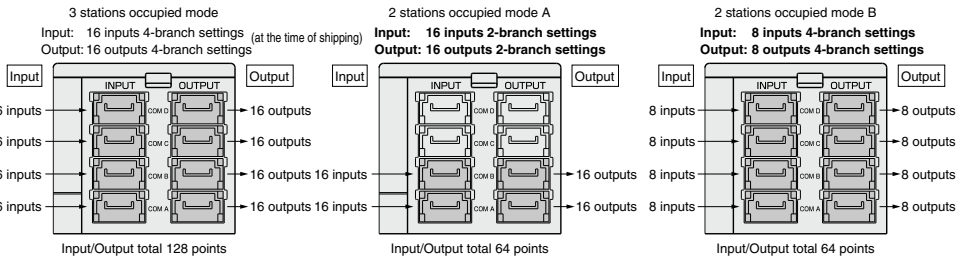

EX510-GDN1 (DeviceNet™ compliant)

Display Setting

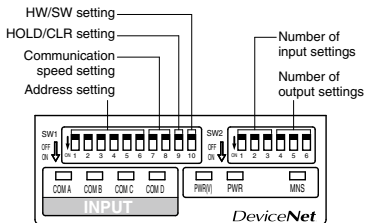

Display	Contents	Indicator light condition
PWR(V)	The output power supply voltage is supplied as specified. The output power supply voltage is not supplied as specified.	Light is turned on. Light is turned off.
PWR	When the input and the power for the Gateway is being supplied. When the input and the power for the Gateway is not being supplied.	Light is turned on. Light is turned off.
MNS	When the power supply is OFF, off-line, or checking the MAC ID duplication. When I/O connection is on stand by (On-line state) I/O connection installation is completed. (On-line state) I/O connection, time-out (communication irregularity in light degrees) MAC ID duplication error, or BUS OFF error (communication error in serious conditions)	Light is turned off. Green light blinks. Green light is turned on. Red light blinks. Red light is turned on.
COM A to D	When COM A to D are receiving data. When COM A to D are not receiving data.	Light is turned on.* Light is turned off.

Internal Circuit

* Input unit (Input device) is connected and will illuminate when communication is working properly.

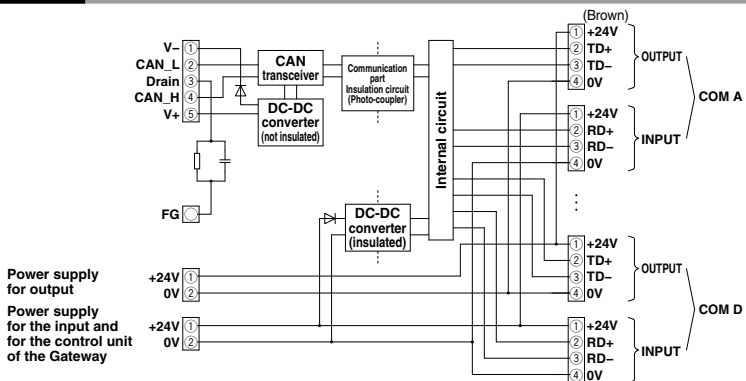

- EX12
- EX140
- EX180
- EX260
- EX250
- EX600
- EX500
- EX510
- PCA
- EX

Flexible I/O Setting Examples

The occupying number of points in the Gateway units can be changed flexibly by setting a switch. (Side view of the Gateway unit) (Grey shaded areas are parts in use.)
The occupying number of inputs and outputs can be set respectively. (Figures below are examples of the flexibility of setting the output occupied numbers.)
Refer to the operation manual for details.

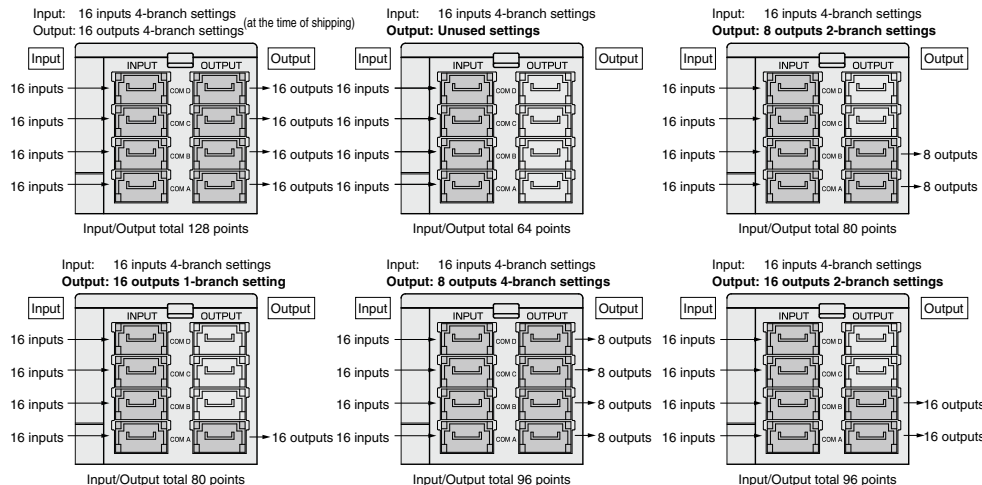

EX510 Series

EX510-GPR1 (PROFIBUS DP compliant)

Display Setting

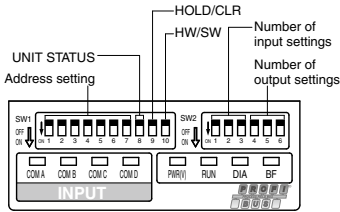

Display	Contents	Indicator light condition
PWR(V)	The output power supply voltage is supplied as specified. The output power supply voltage is not supplied as specified.	Light is turned on. Light is turned off.
RUN	When the input and the power for the Gateway is being supplied. When the input and the power for the Gateway is not being supplied.	Light is turned on. Light is turned off.
DIA	When the extended diagnostic information is available. When the extended diagnostic information is not available.	Light is turned on. Light is turned off.
BF	When PROFIBUS DP communication is working improperly. When PROFIBUS DP communication is working properly.	Light is turned on. Light is turned off.
COM A to D	When COM A to D are receiving data. When COM A to D are not receiving data.	Light is turned on.* Light is turned off.

* Input unit (Input device) is connected will illuminate when communication is working properly.

Internal Circuit

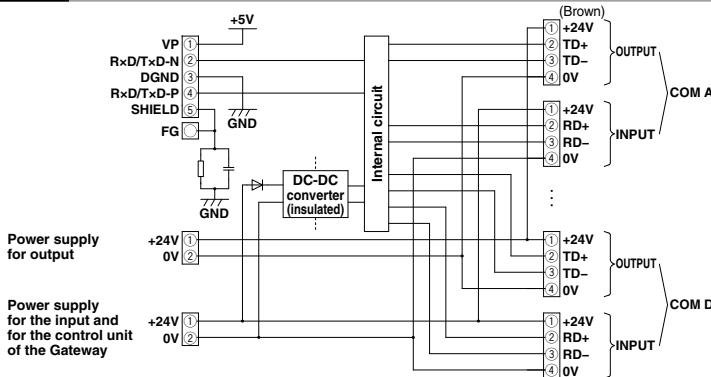

Flexible I/O Setting Examples

The occupying number of points in the Gateway units can be changed flexibly by setting a switch.
The occupying number of inputs and outputs can be set respectively. (Figures below are examples of the flexibility of setting the output occupied numbers.)
Refer to the operation manual for details.

(Side view of the Gateway unit)
[Grey box] are parts in use.

Input: 16 inputs 4-branch settings
Output: 16 outputs 4-branch settings (at the time of shipping)

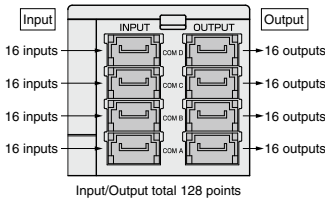

Input: Unused settings
Output: 16 outputs 4-branch settings

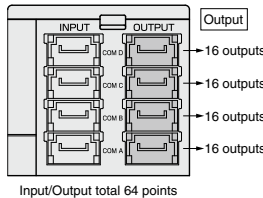

Input: 8 inputs 2-branch settings
Output: 16 outputs 4-branch settings

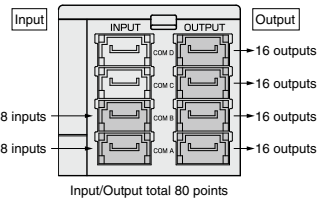

Input: 8 inputs 3-branch settings
Output: 16 outputs 4-branch settings

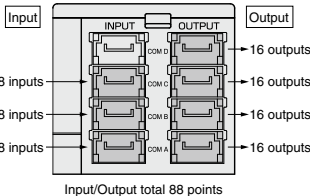

Input: 8 inputs 4-branch settings
Output: 16 outputs 4-branch settings

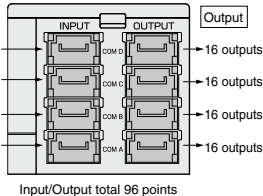

Input: 16 inputs 3-branch settings
Output: 16 outputs 4-branch settings

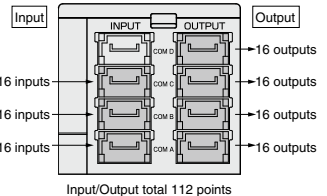

Input Unit

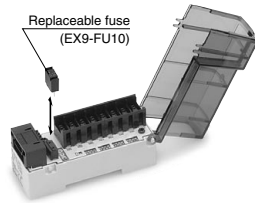

1 connector, 2-input type



1 connector, 1 input type

How to Order

EX510-DX **N** **1**

Compatible sensor

N	NPN output
P	PNP output
B	2-wire type

Unit type

1	1 connector, 2-input type
2	1 connector, 1 input type

Note) B (2-wire type) is available with 1 connector, 2-input type only.

Specifications

Model	EX510-DXN□	EX510-DXP□, DXB1
Input type	NPN sensor input	PNP sensor input
Number of inputs	16 inputs	
Sensor supply voltage	24 VDC	
Max. sensor supply current	0.2 A per point, 0.9 A per unit	
Consumption current	100 mA (Input unit internal parts)	
Input resistance	5.6 kΩ	
Rated input current	Approx. 4 mA	
ON voltage/ON current	17 V or greater/2.5 mA or greater (Between input terminal and for sensor + 24 VDC)	17 V or greater/2.5 mA or greater (Between input terminal and for sensor 0 VDC)
OFF voltage/OFF current	7 V or less/1 mA or less (Between input terminal and for sensor + 24 VDC)	7 V or less/1 mA or less (Between input terminal and for sensor 0 VDC)
Display	Green LED (Illuminated when turned ON)	
Environment	Enclosure	IP10
	Operating temperature range	-10 to 50°C
	Operating humidity range	35 to 85%RH (with no condensation)
	Withstand voltage	500 VAC for 1 min. between whole external terminal and FG
	Insulation resistance	10 MΩ or more (500 VDC) between whole external terminal and FG
Standards	CE marking, UL (CSA)	
Weight	EX510-DX□1: 90 g EX510-DX□2: 110 g (including accessories)	

EX12□
EX140
EX180
EX260
EX250
EX600
EX500
EX510
PCA
EX□

Dimensions

EX510-DX□1

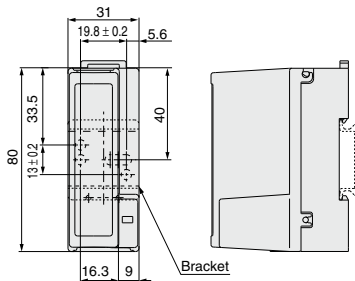

Bracket

EX510-DX□2

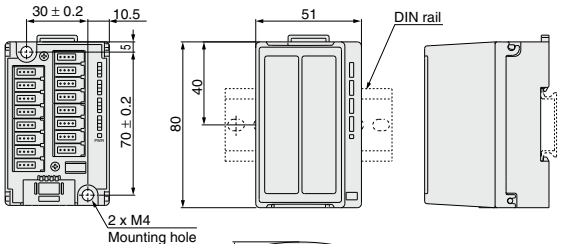

Shown with cover removed.

Bracket (accessory for EX510-DX□1)

Mounting example 1

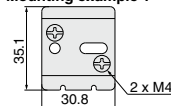

Mounting example 2

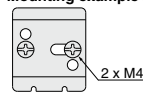

EX510 Series

Parts Description

EX510-DX□1

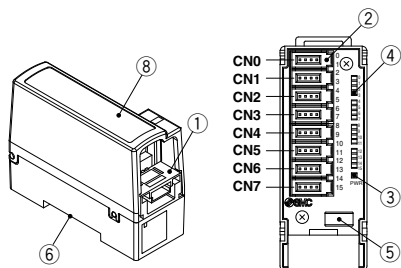

Shown with cover removed.

EX510-DX□2

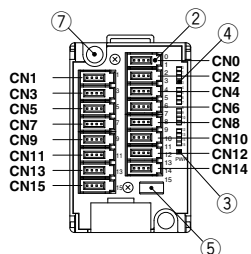

Shown with cover removed.

Accessories



Branch connector (2 pcs.)
(EX510-LC1)

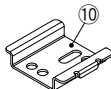

Bracket
* Attached to
EX510-DX□1 only

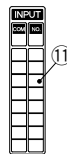

Marker label

Input Unit

No.	Description	Applications
1	Branch connector on the input unit side	For press-fitting the branch connector (9) to the branch cable (EX510-FC□□) for connecting with the GW unit.
2	e-con connector	Connecting sensor, etc.
3	LED for power supply	Light ON: Power supply ON (Normal) state Light OFF: Power supply OFF state
4	LED for display	Light ON: When the input for sensor signal is turned ON. Light OFF: When the input for sensor signal is turned OFF.
5	Fuse	Replaceable fuse (EX9-FU10)
6	Mounting groove for DIN rail	For attaching to a DIN rail or when mounting with screws to an accessory bracket (10).
7	Mounting hole	Used for mounting the unit with two M4 screws.
8	Cover	For protecting the sensor cables. Place a marker label (11) on the top of the body.

Internal Circuits and Wiring Examples

• EX510-DXB1 ... Input unit for 2-wire type (1 connector, 2-input type)

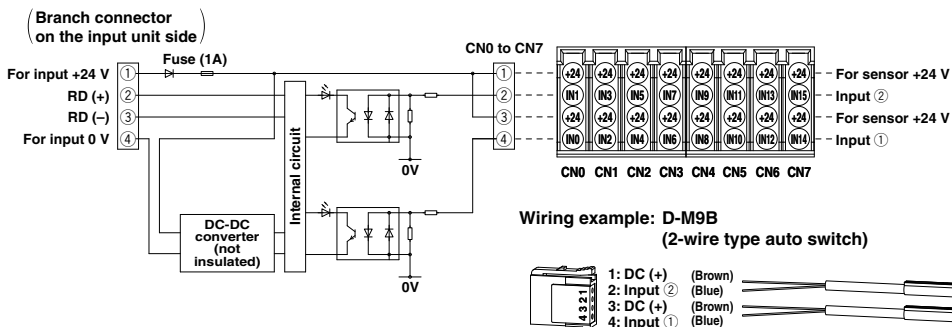

• EX510-DXN1 ... Input unit for NPN (1 connector, 2-input type)

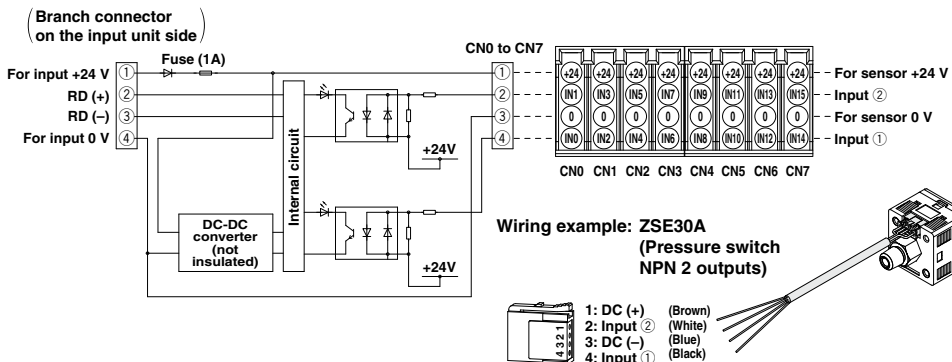

• EX510-DXP1 ... Input unit for PNP (1 connector, 2-input type)

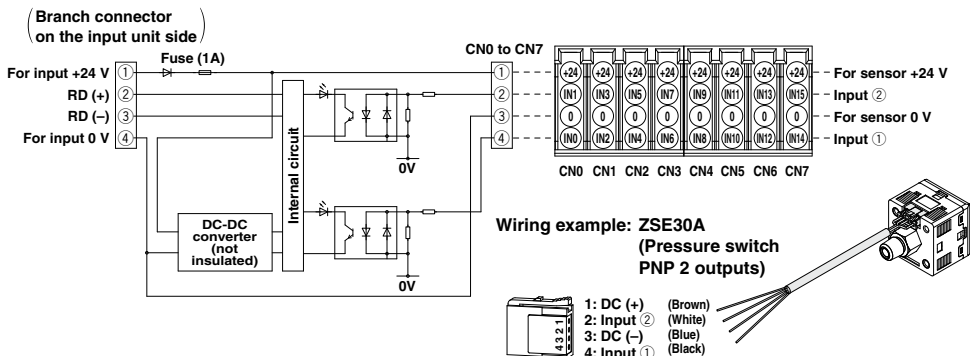

EX12

EX140

EX180

EX260

EX250

EX600

EX500

EX510

PCA

EX

EX510 Series

Internal Circuits and Wiring Examples

• EX510-DXN2 ... Input unit for NPN (1 connector, 1 input type)

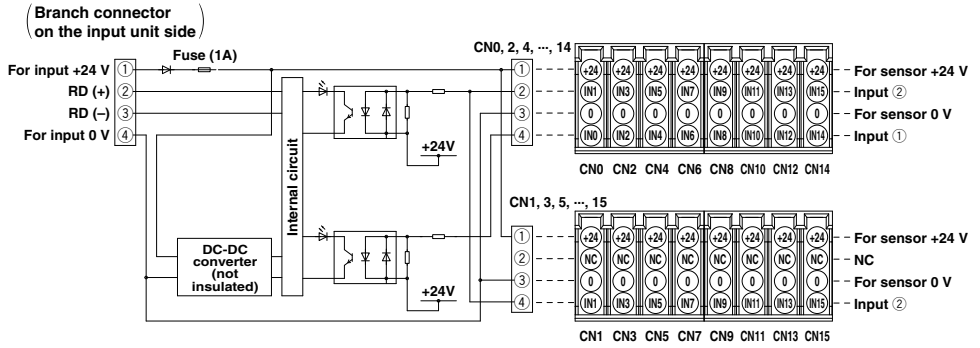

Wiring example: D-M9N

(3-wire type auto switch, NPN output)

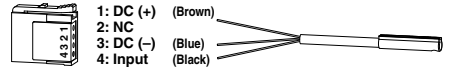

• EX510-DXP2 ... Input unit for PNP (1 connector, 1 input type)

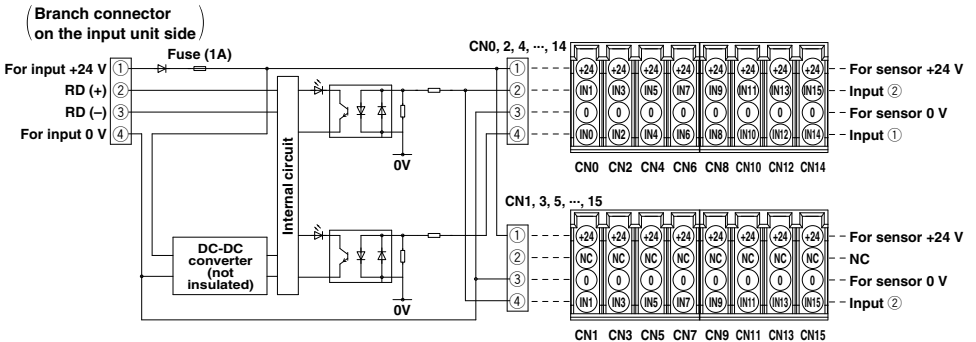

Wiring example: D-M9P

(3-wire type auto switch, PNP output)



Output Unit

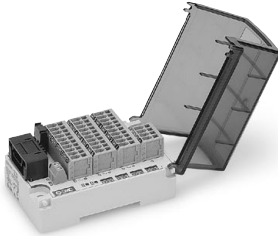

How to Order

EX510-DY P 3

Output specifications

N	Sink/NPN output
P	Source/PNP output

Connector type

3	Terminal box type (Internal power supply)
4	Terminal box type (External power supply)

Specifications

Model	EX510-DYN3	EX510-DYP3	EX510-DYN4	EX510-DYP4
Output type	Sink/NPN (Positive common)	Source/PNP (Negative common)	Sink/NPN (Positive common)	Source/PNP (Negative common)
Rated load voltage	24 VDC			
Power supply type	Internal power supply (supplied by GW unit)		External power supply (supplied by power supply connector)	
Applicable cable for power supply connector	—		0.14 to 1.5 mm ² (AWG16 to 26)	
Number of outputs	16 outputs			
Output connector type	Spring type			
Applicable cable	0.08 to 1.5 mm ² (AWG16 to 28)			
Max. load current	Meet the following 3 conditions: 1. 0.5 A or less per point 2. 1 A or less per unit 3. The total current for OUT0 to 7 must be 1 A or less. The total current for OUT8 to 15 must be 1 A or less.		Meet the following 3 conditions: 1. 0.5 A or less per point 2. 3 A or less per unit 3. The total current for OUT0 to 7 must be 1.5 A or less. The total current for OUT8 to 15 must be 1.5 A or less.	
Protection	Built-in short circuit protection			
Current consumption	50 mA or less (inside a unit)			
Environment	Enclosure	IP10		
	Operating temperature range	-10 to 50°C		
	Operating humidity range	35 to 85%RH (with no condensation)		
	Withstand voltage	500 VAC for 1 min. between whole external terminal and FG		
	Insulation resistance	10 MΩ or more (500 VDC) between whole external terminal and FG		
Standards	CE marking, UL (CSA)			
Weight	130 g (including accessories)			

- EX12
- EX140
- EX180
- EX260
- EX250
- EX600
- EX500
- EX510
- PCA
- EX

Dimensions

EX510-DY

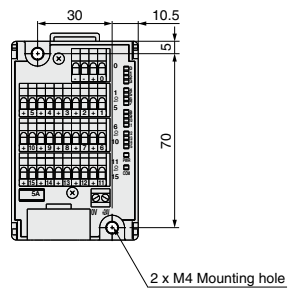
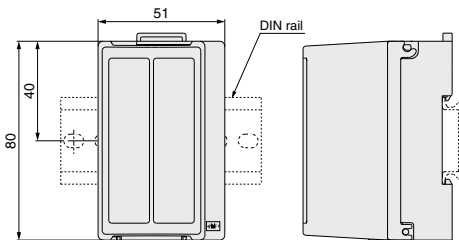

Shown with cover removed.

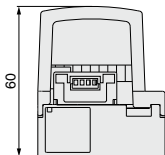

EX510 Series

Parts Description

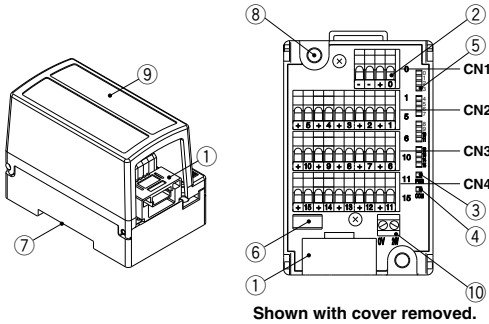

Shown with cover removed.

Accessories



Branch connector (2 pcs.)
(EX510-LC1)

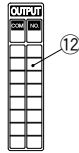

Marker label

Output Unit

No.	Description	Applications
1	Branch connector on the output unit side	For press-fitting the branch connector (11) to the branch cable (EX510-FC□□) for connecting with GW unit.
2	Output terminal box	Connect the output load, etc.
3	LED for power supply	Light ON: Power supply ON (Normal) state Light OFF: Power supply OFF state
4	LED for communications	Light ON: When receiving data Light OFF: When there is no communication data.
5	LED for display	Light ON: When the output signal is turned on. Light OFF: When the output signal is turned off.
6	Fuse	Replaceable fuse
7	Mounting groove	Used for mounting the unit on the DIN rail.
8	Mounting hole	Used for mounting the unit with two M4 screws.
9	Cover	For protecting the output load cable. Place a marker label (12) on the top of the body.
10	Terminal box for external power supply	Terminal for power supply (EX510-DYN4, EX510-DYP4 only)

Internal Circuits and Wiring Examples

• EX510-DYN3 ... Output unit for NPN (Internal power supply type)

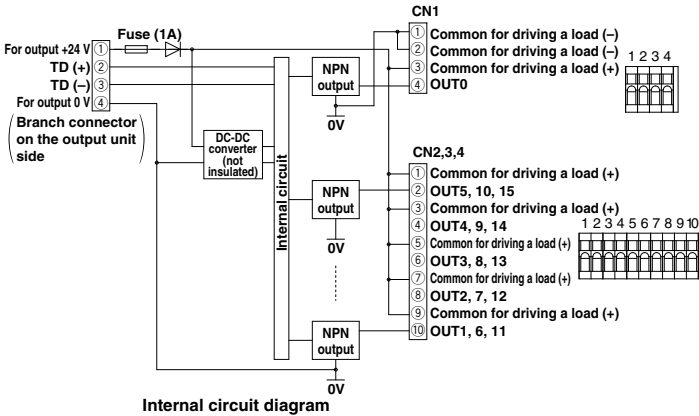

Internal circuit diagram

Terminal Block Connector (CN1)

No.	Description	Functions
CN1		
1	COM	Common for driving a load (-)
2	COM	Common for driving a load (-)
3	COM	Common for driving a load (+)
4	Output	OUT0

Terminal Block Connector (CN2, CN3, CN4)

No.	Description	Functions		
		CN2	CN3	CN4
1	COM	Common for driving a load (+)		
2	Output	OUT5	OUT10	OUT15
3	COM	Common for driving a load (+)		
4	Output	OUT4	OUT9	OUT14
5	COM	Common for driving a load (+)		
6	Output	OUT3	OUT8	OUT13
7	COM	Common for driving a load (+)		
8	Output	OUT2	OUT7	OUT12
9	COM	Common for driving a load (+)		
10	Output	OUT1	OUT6	OUT11

Internal Circuits and Wiring Examples

• EX510-DYN4 ... Output unit for NPN (External power supply type)

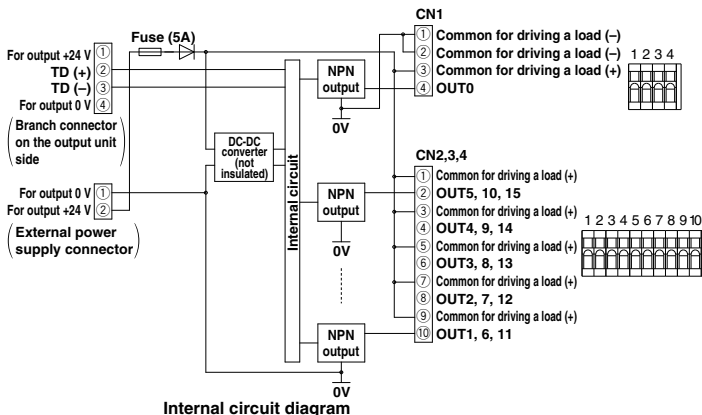

Terminal Block Connector (CN1)

No.	Description	Functions	
		CN1	
1	COM	Common for driving a load (-)	
2	COM	Common for driving a load (-)	
3	COM	Common for driving a load (+)	
4	Output	OUT0	

Terminal Block Connector (CN2, CN3, CN4)

No.	Description	Functions			
		CN2	CN3	CN4	
1	COM	Common for driving a load (+)			
2	Output	OUT5	OUT10	OUT15	
3	COM	Common for driving a load (+)			
4	Output	OUT4	OUT9	OUT14	
5	COM	Common for driving a load (+)			
6	Output	OUT3	OUT8	OUT13	
7	COM	Common for driving a load (+)			
8	Output	OUT2	OUT7	OUT12	
9	COM	Common for driving a load (+)			
10	Output	OUT1	OUT6	OUT11	

• EX510-DYP3 ... Output unit for PNP (Internal power supply type)

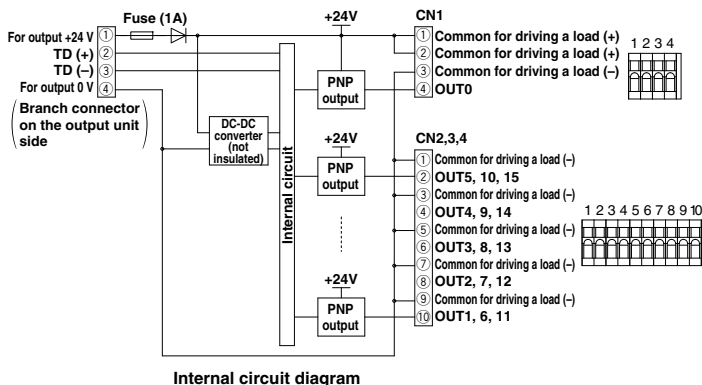

Terminal Block Connector (CN1)

No.	Description	Functions	
		CN1	
1	COM	Common for driving a load (+)	
2	COM	Common for driving a load (+)	
3	COM	Common for driving a load (-)	
4	Output	OUT0	

Terminal Block Connector (CN2, CN3, CN4)

No.	Description	Functions			
		CN2	CN3	CN4	
1	COM	Common for driving a load (-)			
2	Output	OUT5	OUT10	OUT15	
3	COM	Common for driving a load (-)			
4	Output	OUT4	OUT9	OUT14	
5	COM	Common for driving a load (-)			
6	Output	OUT3	OUT8	OUT13	
7	COM	Common for driving a load (-)			
8	Output	OUT2	OUT7	OUT12	
9	COM	Common for driving a load (-)			
10	Output	OUT1	OUT6	OUT11	

EX510 Series

Internal Circuits and Wiring Examples

• EX510-DYP4 ... Output unit for PNP (External power supply type)

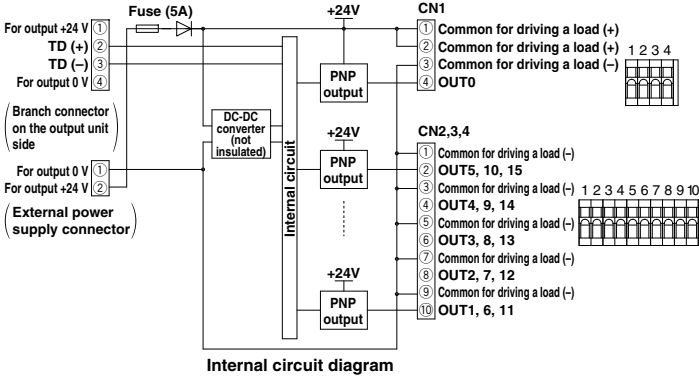

Terminal Block Connector (CN1)

No.	Description	Functions
CN1		
1	COM	Common for driving a load (+)
2	COM	Common for driving a load (+)
3	COM	Common for driving a load (-)
4	Output	OUT0

Terminal Block Connector (CN2, CN3, CN4)

No.	Description	Functions			
		CN2	CN3	CN4	
1	COM	Common for driving a load (-)			
2	Output	OUT5	OUT10	OUT15	
3	COM	Common for driving a load (-)			
4	Output	OUT4	OUT9	OUT14	
5	COM	Common for driving a load (-)			
6	Output	OUT3	OUT8	OUT13	
7	COM	Common for driving a load (-)			
8	Output	OUT2	OUT7	OUT12	
9	COM	Common for driving a load (-)			
10	Output	OUT1	OUT6	OUT11	

Connection to Output Equipment

The output unit can be connected to 2-port solenoid valves such as the VX, VCW, VDW series and other 3-port valves. Pay attention to the applicable cable and maximum load current for selecting a solenoid valve. The 2-port valves other than shown below can be used as long as they meet the conditions; operating environment (enclosure, etc.), applicable cable and the **maximum load current**. Shown below is the typical 2-port solenoid valve. Additionally, we recommend a model with surge voltage suppressor is used for the 2-port solenoid valve.

Example) In the case of using 5 VX23 series (rated voltage: 24 VDC/ power consumption: 10.5 W) (calculated under the condition with 5 valves turned on simultaneously)

Operating current per point for a valve
 $10.5 \text{ (W)} \div 24 \text{ (V)} = 0.44 \text{ (A)}$ Meets the output unit load current requirement 1.

Therefore, the total current of the output unit is:
 $10.5 \text{ (W)} \div 24 \text{ (V)} \times 5 \text{ (pcs.)} = 2.2 \text{ (A)}$ Only the external power supply type can meet the requirement 2. The internal power supply type cannot be used.

Based on the requirement 3, The total current for OUT0 to 7 and OUT8 to 15 are 1.5 (A) respectively.

Therefore, 3 VX valves are wired for either 3 points of OUT0 to 7. (1.32 (A) for OUT0 to 7)
 2 VX valves are wired for either 2 points of OUT8 to 15. (0.88 (A) for OUT8 to 15)

Other outputs can be made available by reducing the total number of the occupied points for simultaneous operation.

Load Current Requirement

Model	EX510-DYN3	EX510-DYP3	EX510-DYN4	EX510-DYP4
Output type	Sink/NPN (Positive common)	Source/PNP (Negative common)	Sink/NPN (Positive common)	Source/PNP (Negative common)
Power supply type	Internal power supply (supplied by GW unit)		External power supply (supplied by power supply connector)	
Max. load current	Meet the following 3 conditions: 1. 0.5 A or less per point 2. 1 A or less per unit 3. Total current for OUT 0 to 7 must be 1 A or less. Total current for OUT 8 to 15 must be 1 A or less.		Meet the following 3 conditions: 1. 0.5 A or less per point 2. 3 A or less per unit 3. Total current for OUT 0 to 7 must be 1.5 A or less. Total current for OUT 8 to 15 must be 1.5 A or less.	

Direct Operated 2 Port Solenoid Valve

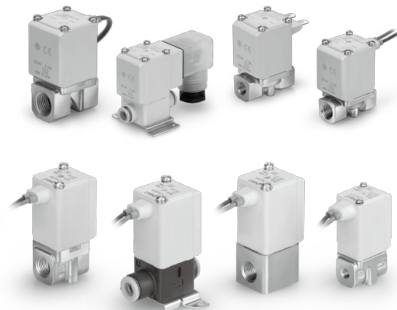

VX

Series	Body material	Port size	Orifice diameter [mmø]	Power consumption [W]
VX21	A1, Resin C37, Stainless steel	1/8 to 1/2	2 to 10	4.5
VX22		One-touch fitting:		7
VX23		ø6 to ø12		10.5

VDW

Series	Body material	Port size	Orifice diameter [mmø]	Power consumption [W]
VDW10	A1, Resin C37, Stainless steel	M5 to 1/8	1.0 to 3.2	2.5
VDW20		One-touch fitting:		3

SI Unit

How to Order

EX510-S□0□1□□

Output specifications

0	Sink/NPN (Positive common)
1	Source/PNP (Negative common)

Mounting specifications

Nil	Screen mounting
A	Mounting on DIN rail vertically
B	Mounting on DIN rail horizontally
C	Mounting on DIN rail horizontally (Dedicated for the SJ manifold) ^{Note)}

Applicable valve manifold

1	Plug-lead manifold
2	Plug-in manifold

Note) Applicable for EX510-S□02 only.

Specifications

Model	EX510-S001□, S002□	EX510-S101□, S102□
Output type	Sink/NPN (Positive common)	Source/PNP (Negative common)
Number of outputs	16 outputs	
Rated load voltage	24 VDC	
Max. load current	Meet the following 3 conditions: 1. 0.25 A or less per point 2. 1.4 A or less per unit 3. Total current for OUT 0 to 7 must be 1 A or less. Total current for OUT 8 to 15 must be 1 A or less.	
Enclosure	Built-in short circuit protection	
Current consumption	50 mA or less (SI unit internal parts)	
Environment	Enclosure	IP20
	Operating temperature range	-10 to 50°C
	Operating humidity range	35 to 85%RH (with no condensation)
	Withstand voltage	500 VAC for 1 min. between whole external terminal and FG
Insulation resistance	10 MΩ or more (500 VDC) between whole external terminal and FG	
Standards	CE marking, UL (CSA)	
Weight	EX510-S□01: 40 g	EX510-S□01A, B: 80 g
	EX510-S□02: 50 g	EX510-S□02A, B, C: 90 g (including accessories)

- EX12□
- EX140
- EX180
- EX260
- EX250
- EX600
- EX500
- EX510
- PCA
- EX□

Dimensions

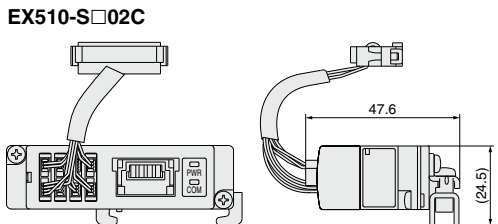
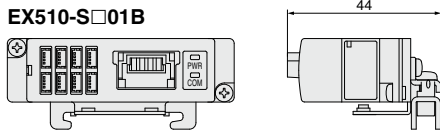
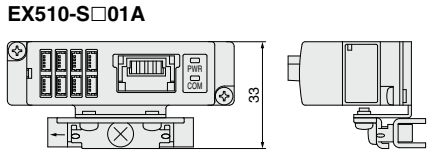
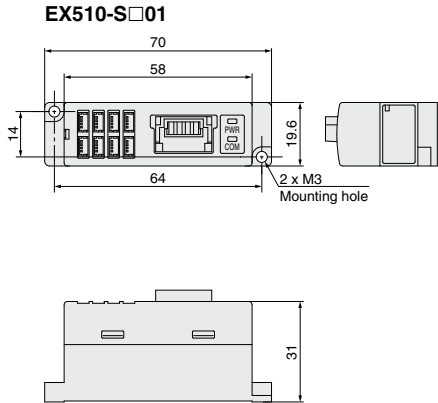

EX510 Series

Parts Description

You can place an order for the manifold (valve series mentioned below) with the SI unit. For further information, please refer to the individual valve/manifold catalog. Also, you can change the system of your device by retrofitting the SI unit with the manifold already purchased.

EX510-S□01

(SY, SYJ, S0700, VQZ series)

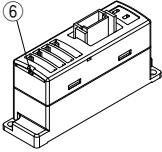

EX510-S□01A

(SY series (Type 45))

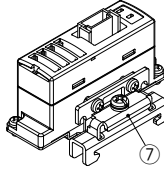

EX510-S□01B

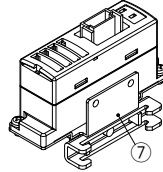

EX510-S□02

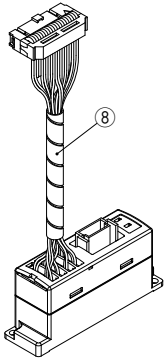

EX510-S□02A

(SY, VQ series)

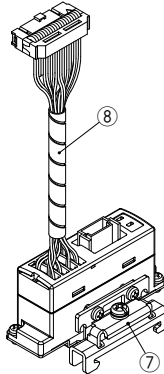

EX510-S□02B

(SZ, SQ series)

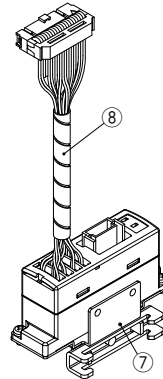

EX510-S□02C

(SJ series)

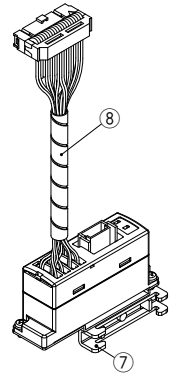

Accessories



Branch connector (2 pcs.)
(EX510-LC1)

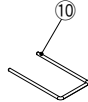

Connector lock pin
(1 pc.)

SI Unit

No.	Description	Applications
1	Branch connector on the SI side unit	For press-fitting the branch connector (9) to the branch cable (EX510-FC□□) for connecting with the GW unit.
2	Connector for connecting a load	Connects an output device such as a solenoid valve.
3	LED for power supply	Light ON: Power supply ON (Normal) state Light OFF: Power supply OFF state
4	LED for communications	Light ON: When receiving data Light OFF: When there is no communication data.
5	Mounting hole	Used for mounting the unit with two M3 screws.
6	Connector lock pin insertion part	Used for attaching a unit with a connector lock pin (10). (EX510-S□02□ is inserted.)
7	Mounting bracket	Can be mounted on DIN rail.
8	Covercion cable assembly	The cable assembly used for connecting to the plug-in valve manifold. (MIL connector, 20 pins, socket)

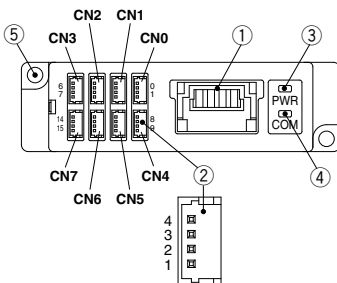

Internal Circuits and Wiring Examples

EX510-S001/NPN output

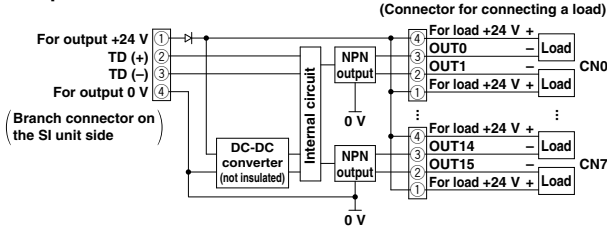

EX510-S002/NPN output

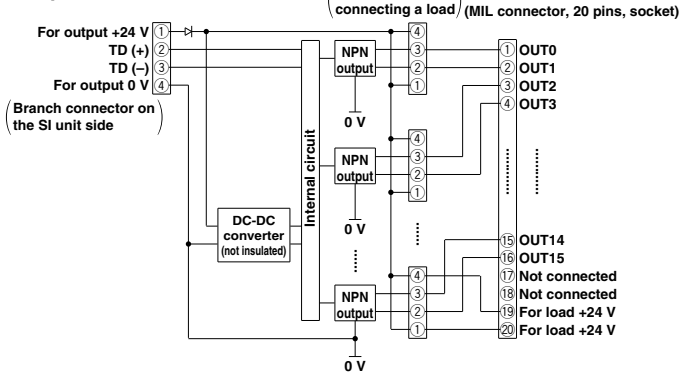

EX510-S101/PNP output

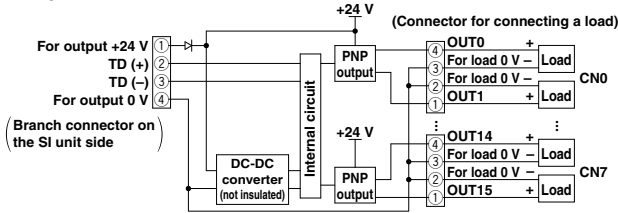

EX510-S102/PNP output

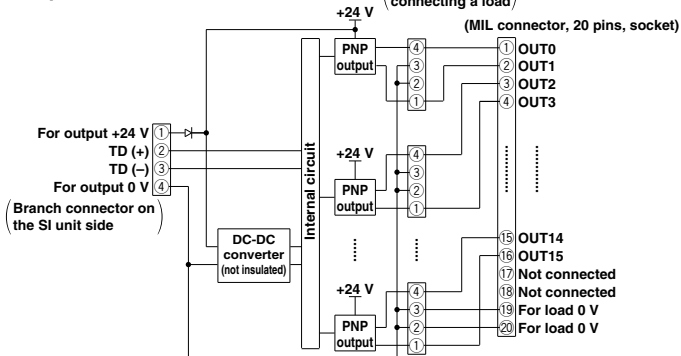

EX12	<input type="checkbox"/>
EX140	<input type="checkbox"/>
EX180	<input type="checkbox"/>
EX260	<input type="checkbox"/>
EX250	<input type="checkbox"/>
EX600	<input type="checkbox"/>
EX500	<input type="checkbox"/>
EX510	<input checked="" type="checkbox"/>
PCA	<input type="checkbox"/>
EXC	<input type="checkbox"/>

EX510 Serial Wiring Compatible 5 Port Solenoid Valves

Plug-lead Type Manifold



For details, refer to page 397.

SY

Series	Sonic conductance: C [dm ³ /(s·bar)] (representative value)	Applicable cylinder size (reference)	Port size for A, B ports												
			Piping with One-touch fittings								Thread piping				
			Metric size					Inch size							
			ø4	ø6	ø8	ø10	ø12	ø5/32"	ø1/4"	ø5/16"	ø3/8"	M5	1/8	1/4	3/8
SY3000	1.1	ø40	●	●				●	●			●	●		
SY5000	2.8	ø63	●	●	●			●	●	●			●	●	
SY7000	4.5	ø80			●	●				●	●			●	
SY9000	10.0	ø100			●	●	●			●	●			●	●



For details, refer to the Best Pneumatics No. 1-2.

SYJ

Series	Sonic conductance: C [dm ³ /(s·bar)] (representative value)	Applicable cylinder size (reference)	Port size for A, B ports								
			Piping with One-touch fittings						Thread piping		
			Metric size			Inch size					
			ø4	ø6	ø8	ø5/32"	ø1/4"	ø5/16"	M3	M5	1/8
SYJ3000	0.46	ø25	●			●	●		●		
SYJ5000	0.83	ø40	●	●		●	●			●	
SYJ7000	2.9	ø50		●	●		●	●			●

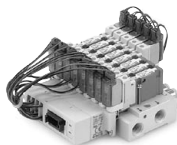

For details, refer to page 645.

S0700

Series	Sonic conductance: C [dm ³ /(s·bar)] (representative value)	Applicable cylinder size (reference)	Port size for A, B ports				
			Piping with One-touch fittings				Thread piping
			Metric size		Inch size		
			ø3.2	ø4	ø1/8"	ø5/32"	M5
S0700	0.37	ø25	●	●	●	●	●



For details, refer to the Best Pneumatics No. 1-2.

VQZ

Series	Sonic conductance: C [dm ³ /(s·bar)] (representative value)	Applicable cylinder size (reference)	Port size for A, B ports												
			Piping with One-touch fittings								Thread piping				
			Metric size					Inch size							
			ø3.2	ø4	ø6	ø8	ø10	ø1/8"	ø5/32"	ø1/4"	ø5/16"	ø3/8"	M5	1/8	1/4
VQZ1000	1.2	ø40	●	●	●			●	●	●			●		
VQZ2000	2.0	ø63		●	●	●			●	●	●			●	
VQZ3000	3.9	ø80			●	●	●			●	●	●			●

Plug-in Type Manifold



SJ For details, refer to page 13.

Series	Sonic conductance: C [dm ³ /(s·bar)] (representative value)	Applicable cylinder size (reference)	Port size for A, B ports						
			Piping with One-touch fittings				Thread piping		
			Metric size		Inch size				
SJ2000	0.36	ø25	●	●	●	●	●	●	●
SJ3000	0.56	ø32	●	●	●	●	●	●	●



SZ For details, refer to the Best Pneumatics No. 1-2.

Series	Sonic conductance: C [dm ³ /(s·bar)] (representative value)	Applicable cylinder size (reference)	Port size for A, B ports						
			Piping with One-touch fittings				Thread piping		
			Metric size		Inch size				
SZ3000	0.77	ø32	●	●	●	●	●	●	●



For details, refer to page 123.

Series	Sonic conductance: C [dm ³ /(s·bar)] (representative value)	Applicable cylinder size (reference)	Port size for A, B ports														
			Piping with One-touch fittings								Thread piping						
			Metric size				Inch size										
SY3000	1.1	ø50	●	●	●	●	●	●	●	●	●	●	●	●	●	●	●
SY5000	2.6	ø63			●	●	●	●	●	●	●	●	●	●	●	●	●
SY7000	4.0	ø80					●	●						●			●



SY For details, refer to page 397.

Series	Sonic conductance: C [dm ³ /(s·bar)] (representative value)	Applicable cylinder size (reference)	Port size for A, B ports							
			Piping with One-touch fittings							
			Metric size			Inch size				
SY3000	1.1	ø40	●	●		●	●	●	●	●
SY5000	2.8	ø63	●	●	●	●	●	●	●	●

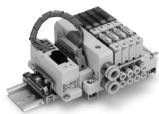

S0700/Slim Compact For details, refer to page 645.

Series	Sonic conductance: C [dm ³ /(s·bar)] (representative value)	Applicable cylinder size (reference)	Port size for A, B ports					
			Piping with One-touch fittings					
			Metric size			Inch size		
S0700	0.37	ø25	●	●	●	●	●	●

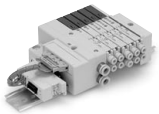

SQ For details, refer to the Best Pneumatics No. 1-2.

Series	Sonic conductance: C [dm ³ /(s·bar)] (representative value)	Applicable cylinder size (reference)	Port size for A, B ports										
			Piping with One-touch fittings						Thread piping				
			Metric size				Inch size						
SQ1000	0.83	ø32	●	●	●	●	●	●	●	●	●	●	●
SQ2000	2.9	ø63	●	●	●	●	●	●	●	●	●	●	●



VQ For details, refer to the Best Pneumatics No. 1-2.

Series	Sonic conductance: C [dm ³ /(s·bar)] (representative value)	Applicable cylinder size (reference)	Port size for A, B ports									
			Piping with One-touch fittings						Thread piping			
			Metric size				Inch size					
VQ1000	1.0	ø40	●	●	●	●	●	●	●	●	●	●
VQ2000	3.2	ø63	●	●	●	●	●	●	●	●	●	●

- EX12
- EX140
- EX180
- EX260
- EX250
- EX600
- EX500
- EX510
- PCA
- EX1

EX510 Series

System Composition/Options

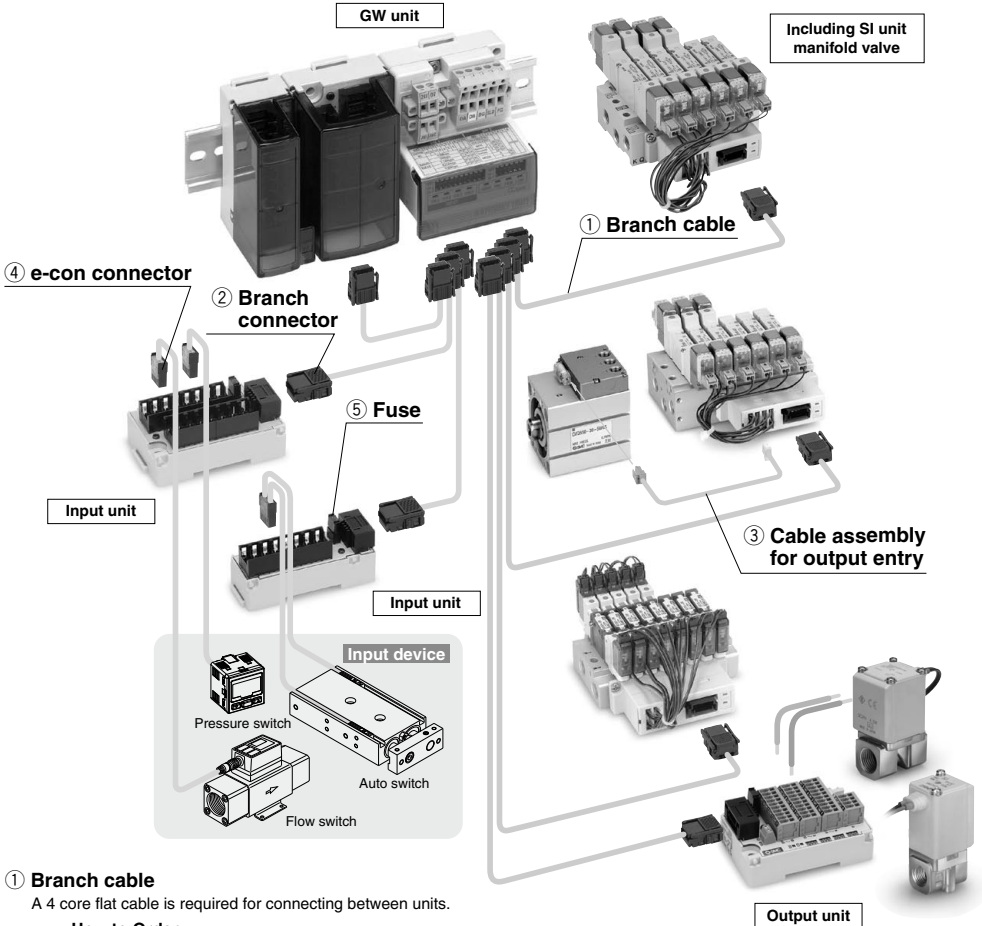

① Branch cable

A 4 core flat cable is required for connecting between units.

How to Order

EX510-FC 10

Cable length (L)

01	1 m
02	2 m
05	5 m
10	10 m
20	20 m
60 (Note)	60 m

Note) Branch cable length is a maximum of 20 m. Use the cable by cutting it into lengths of 20 m or shorter.

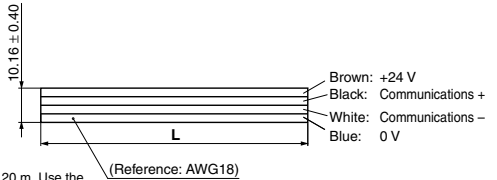

② Branch connector (Unit 1 pc.)

Connector required for connecting a branch cable to each unit.

Two branch cables are attached to the SI unit, the input unit and the output unit respectively.

How to Order

EX510-LC1



(When press-fitting)

Electrical specifications	
Rated voltage	24 VDC
Rated current	Max. 5.0 A
Contact resistance	20 mΩ or less
Withstand voltage	1000 VAC 1 minute (Leak current 1 mA or less)

③ **Cable assembly for outputting**

Cable assembly for connecting the unused outputs in the SI unit.

How to Order

EX510-V S 10 S

Output	
S	1 point
W	2 points

Valve connector	
Nil	None
S	For SY, SYJ series
Q	For VQ, VQZ series <small>(Note)</small>

Cable length (L)	
10	1 m
30	3 m

Note) VQ is compatible with the positive common only.

EX510-VS□S

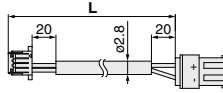

EX510-VS□Q

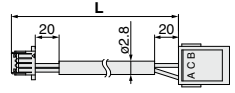

EX510-VW□S

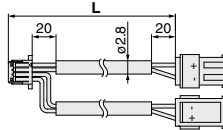

EX510-VW□Q

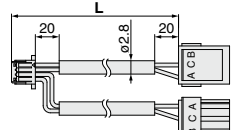

④ **e-con connector**

Connector for connecting a sensor to the input unit (EX510-DX□□).
For applicable wire, refer to the right table.

How to Order

ZS-28-C □ □ - □ □

e-con

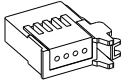

Applicable Wire

SMC part no. (1 pc.)	Cover color	Compliant wire diameter (φ)	Nominal cross sectional area (mm ²)*1	Tyco Electronics Japan G.K. part no.
ZS-28-CA-1	Orange	0.6 to 0.9	0.1 to 0.5 (AWG26 to 20*2)	3-1473562-4
ZS-28-CA-2	Red	0.9 to 1.0		1-1473562-4
ZS-28-CA-3	Yellow	1.0 to 1.15		1473562-4
ZS-28-CA-4	Blue	1.15 to 1.35		2-1473562-4
ZS-28-CA-5	Green	1.35 to 1.60		4-1473562-4
SMC part no. (1 pc.)	Cover color	Compliant wire diameter (φ)	Nominal cross sectional area (mm ²)*1	3M Japan Limited part no.
ZS-28-C	Red	0.8 to 1.0	0.14 to 0.2 (AWG26 to 24*2)	37104-3101-000FL
ZS-28-C-1	Yellow	1.0 to 1.2		37104-3122-000FL
ZS-28-C-2	Orange	1.2 to 1.6	0.3 to 0.5 (AWG22 to 20*2)	37104-3163-000FL
ZS-28-C-3	Green	1.0 to 1.2		37104-2124-000FL
ZS-28-C-4	Blue	1.2 to 1.6		37104-2165-000FL
ZS-28-C-5	Gray	1.6 to 2.0		37104-2206-000FL
SMC part no. (1 pc.)	Cover color	Compliant wire diameter (φ)	Nominal cross sectional area (mm ²)*1	OMRON Corp. part no.
—	Clear	UP to 1.5	0.08 to 0.5 (AWG28 to 20*2)	XN2A-1470

*1: Nominal sectional area is the value provided by the manufacturer.

*2: AWG size is a reference.

⑤ **Replacement fuse**

Replacement fuse for the input unit (EX510-DX□□) and the output unit (EX510-DY□□).

How to Order

EX9-FU10

Fuse rated current

10	1 A
50	5 A

Fuse



Part no.	Electrical specifications	
	EX9-FU10	EX9-FU50
Applicable model	EX510-DX□□ EX510-DY□□	EX510-DY□□
Rated current	1 A	5 A
Rated insulation capacity	48 VAC/DC 50 A	
Fuse resistance value	0.145 Ω	18 mΩ

EX12□

EX140

EX180

EX260

EX250

EX600

EX500

EX510

PCA

EX□

EX510 Series

Ordering Examples

Shown is an example for ordering the EX510 series.

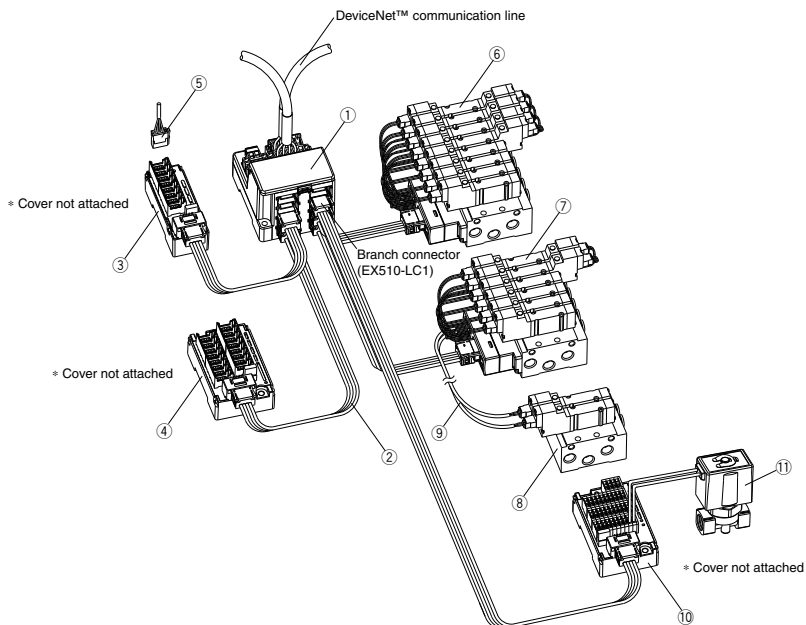

① Gateway unit (DeviceNet™ compliant)	EX510-GDN1	1 unit
② Branch cable 20 meters	EX510-FC20	1 roll
* ③ Input unit (1 connector, 2-input type NPN input)	EX510-DXN1	1 unit
* ④ Input unit (1 connector, 1 input type NPN input)	EX510-DXN2	1 unit
⑤ e-con	ZS-28-□	24 pcs.
* ⑥ SY series manifold	SS5Y3-42SA-08-C6	1 unit
	* SY3140-5LOZ	4 units
	* SY3240-5LOZ	4 units
* ⑦ VQZ series manifold	VV5QZ15-SA06C6	1 unit
	* VQZ1150-5LO1	4 units
	* VQZ1250-5LO1	2 units
⑧ SY series manifold	SS5Y3-42-02-C6	1 unit
	* SY3140-5LOZ	2 units
⑨ Cable assembly for output entry.....	EX510-VW10S	1 pc.
* ⑩ Output unit	EX510-DYN3	1 unit
⑪ 2 port solenoid valve	VX2120-02-5GS1	1 pc.

* Two branch connectors are attached to the manifold including the SI unit and two are attached to the input unit and the output unit respectively.
The branch connector (EX510-LC1) is used to connect the individual units.



EX510 Series

Specific Product Precautions 1

Be sure to read this before handling the products.

Design and Selection

Warning

- 1. Use within the allowable voltage range.**
Using beyond the allowable voltage range is likely to cause the units and connecting devices to be damaged or to malfunction.
- 2. Do not use beyond the specifications range.**
Using beyond the specifications range is likely to cause a fire, malfunction, or breakdown in the units and connecting devices. Check the specifications before handling.
- 3. Establish a backup system beforehand, which employs fail-safe concepts such as multiple equipment and devices to prevent breakage or malfunction of this product.**
- 4. Provide an external emergency stop circuit that will immediately stop an operation and cut off the power supply.**
- 5. When using for an interlock circuit:**
 - Provide a double interlock which is operated by another system (such as mechanical protection function).
 - Perform an inspection to check that it is working properly because it can cause possible injuries.

Caution

- 1. Keep the surrounding space free for maintenance.**
When designing a system, take into consideration the amount of free space needed for performing maintenance.
- 2. When applicable to UL, use a Class 2 power supply unit conforming to UL1310 for DC power supply.**
- 3. This product is one of the components to be equipped into a final equipment. Confirm the adaptability to the EMC directive as the whole equipment by customers themselves.**

Mounting

Caution

- 1. Do not drop, bump, or apply excessive impact.**
Otherwise, the unit can become damaged, malfunction, or fail to function.
- 2. Hold the body while handling this product.**
Otherwise, the unit can become damaged, malfunction, or fail to function.
- 3. Observe the tightening torque range**
Tightening outside of the allowable torque range will likely damage the product.
- 4. Do not install a unit in a place where it can be used as a scaffold.**
Applying any excessive load such as stepping on the unit by mistake or placing a foot on it, will cause it to break.

EX12	<input type="checkbox"/>
EX140	
EX180	
EX260	
EX250	
EX600	
EX500	
EX510	
PCA	
EX	<input type="checkbox"/>



EX510 Series

Specific Product Precautions 2

Be sure to read this before handling the products.

Wiring

⚠ Warning

1. Avoid miswiring.

If miswired, there is a probability of damaging units or connecting devices.

2. Do not wire while energizing the product.

It is likely to damage the units or connecting devices.

3. Avoid wiring the power line and high pressure line in parallel.

Noise or surge produced by signal line resulting from the power line or high pressure line could cause a malfunction. Wiring of the reduced-wiring system and the power line or high pressure line should be separated from each other.

4. Confirm the wiring insulation.

Inferior insulation (contact with other circuit, insulation between terminals, etc.) will likely cause damage to the units or connecting devices due to excessive voltage or the influx of current.

⚠ Caution

1. Take measures to avoid applying repeated bending force or pulling force to the cable.

Also, pay attention not to place any heavy matter on the cable or clipping. It is likely to cause a broken wire.

2. Confirm grounding to maintain the safety of the reduced wiring system and for anti-noise performance.

Grounding should be close to units and keep the grounding distance short.

Operating Environment

⚠ Warning

1. Do not use this product in the presence of dust, particles, water, chemicals, and oil.

Use with such materials is likely to cause a malfunction or breakage.

2. Do not use this product in the presence of a magnetic field.

Use in such an environment is likely to cause a malfunction.

3. Do not use this product in an atmosphere containing an inflammable gas, explosive gas, or corrosive gas.

Use in such an atmosphere is likely to cause a fire, explosion, or corrosion.

This reduced-wiring system is not explosion-proof.

4. Do not use this product in places where there are cyclic temperature changes.

In case that the cyclic temperature is beyond normal temperature changes, the internal unit is likely to be adversely effected.

5. Do not use this product in places where there is radiated heat around it.

Such a place is likely to cause a malfunction or breakage.

Operating Environment

⚠ Warning

6. Do not use this product near sources that generate a surge which exceeds the benchmark test, even though this product is CE-marked certified.

The internal circuit components are likely to deteriorate or become damaged when there are equipment (solenoid type lifter, high frequency guided furnace, motor, etc.) which generate a large surge around the reduced-wiring system. Take measures to prevent an electrical surge and avoid having the wires touch each other.

7. Use the product type that has an integrated-surge absorption element when directly driving a load which generates surge voltage by relay or solenoid valves.

8. The reduced wiring system should be installed in places with no vibration or shock.

If installed in a place with vibration or shock, a malfunction or breakage is likely to occur.

Adjustment and Operation

⚠ Warning

1. Do not short-circuit a load.

If a load is short-circuited, excessive can cause damage to the connected devices. The fuse of the input unit will melt and below. The output and SI unit will activate its overcurrent protection function. However, they cannot cover all modes, so damage is likely to occur.

2. Do not manipulate or perform settings with wet hands.

Performing such activity will likely cause an electrical shock.

⚠ Caution

1. DIP switches should be set with a small watchmaker's screwdriver.

Maintenance

⚠ Warning

1. Do not disassemble, modify (including circuit board replacement) or repair this product.

Such actions are likely to cause injuries or breakage.

2. Perform periodic inspection.

Confirm that wiring or screws are not loose. Otherwise, unpredicted malfunction in the system composition devices is likely to occur.

3. When an inspection is performed.

- Turn off the power supply.
- Stop the supplied fluid and discharge the fluid in the piping and confirm the release to the atmosphere before performing an inspection. It is likely to cause injuries.

⚠ Caution

1. Do not wipe this product with chemicals such as benzene or thinner.

Using such chemicals is likely to cause damage.