

Power Valve: Regulator Valve

VEX1 Series

Large capacity relief regulator

Rapid tank internal pressure setting, air blow, constant pressure supply and driving, balance and driving, 2 steps directional control setting and multiple steps pressure control

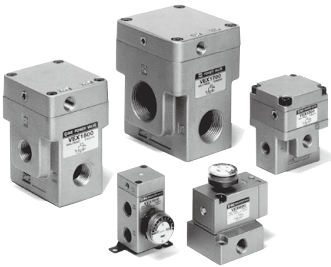

Air operated



External pilot solenoid

Symbol

Air operated

External pilot solenoid

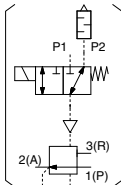
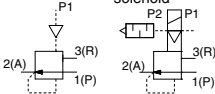

Specifications

Model	VEX110□-01-02	VEX120□-01-02	VEX130□-02-03-04	VEX150□-04-06-08-10-12	VEX190□-14-20									
Operation type	Air operated, External pilot solenoid													
Fluid	Air													
Max. operating pressure	1.0 MPa													
Set pressure range	Air operated		0.05 to 0.9 MPa											
	Solenoid		0.05 to 0.7 MPa		0.05 to 0.9 MPa									
Ambient and fluid temp.	0 to 50°C (Air operated: 0 to 60°C) No condensation													
Hysteresis	0.03 MPa													
Repeatability	0.01 MPa													
Sensitivity	0.01 MPa													
Mounting	Free													
Lubrication	Not required (Use turbine oil Class 1 ISO VG32, if lubricated.)													
Port size	Port	01	02	01	02	02	03	04	06	10	10	12	14	20
	1(P)										1			
	2(A)	1/8	1/4	1/8	1/4	1/4	3/8	1/2	1/2	3/4	1	1 1/4	1 1/2	2
3(R)														
Weight (kg)	Air operated	0.1	0.2	0.4	1.3	1.9	3.9							
	Solenoid	0.2	0.3	0.5	1.4	2.0	4.0							

Note) Non-lubricated specifications are not available for this product.

Pilot Solenoid Valve Specifications

Model	VEX1101 / 1201 / 1301	VEX1501 / 1701 / 1901
Pilot valve	VK334-□□□	VO307K-□□□1
Electrical entry	Grommet, DIN terminal	Grommet, DIN terminal
Coil rated voltage (V)	AC(50/60Hz)	100 V, 110 V, 200 V, 220 V, 240 V
	DC	12 V, 24 V
Allowable voltage	±10% of rated voltage	-15 to +10% of rated voltage
Apparent	AC	Inrush 9.5 VA/50 Hz, 8 VA/60 Hz
	Holding	7 VA/50 Hz, 5 VA/60 Hz
power	DC	4 W (Without indicator light), 4.3 W (With indicator light)
	DC	4 W (Without indicator light), 4.2 W (With indicator light)
Manual override	Non-locking push type	

Option

Description	Part no.					
	VEX110□-01-02	VEX120□-01-02	VEX130□-02-03-04	VEX150□-04-06-08-10-12	VEX170□-10-12	VEX190□-14-20
Bracket (With bolt and washer)	B	VEX1-18-1A	—	VEX3-32A	VEX5-32A	VEX7-32A
Pressure gauge ^{Note)}	F	VEX1-18-2A	—	—	—	—
	G	G27-10-01	G36-10-01	—	—	G46-10-01

Note) When requiring a gauge different than that mentioned above, specify the model number.

Option is packed with it.
(Refer to Best Pneumatics No. 7.)
Example: VEX1300-03
G36-4-01

How to Order

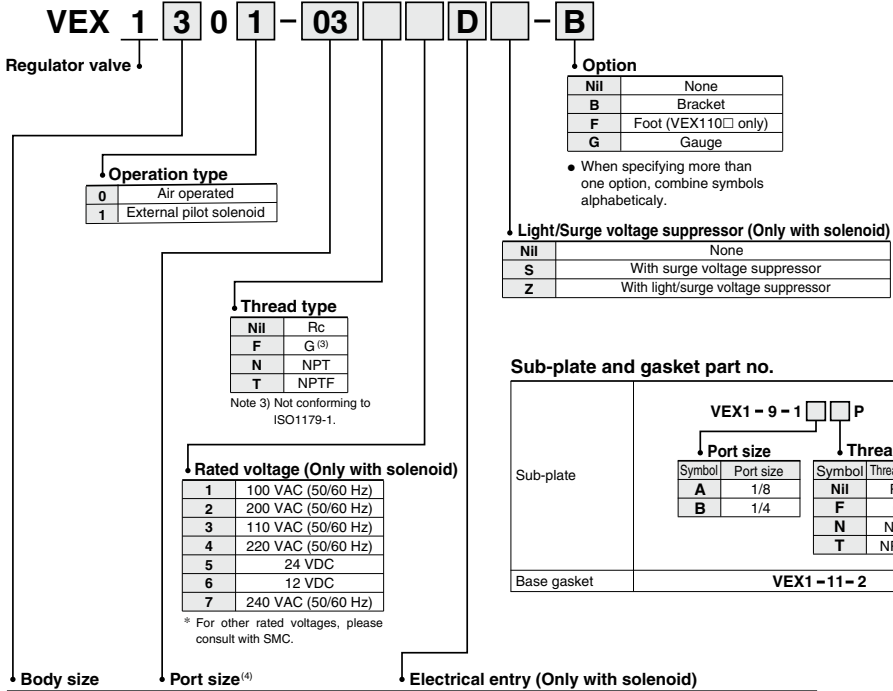

Body size	Port size			Electrical entry (Only with solenoid)	Light/Surge voltage suppressor (Only with solenoid)			
	Port	1(F), 2(A)	3(R)		Nil	S	Z	
Body ported	1	01	1/8	1/8	G: Grommet (300 mm)	●	●	×
		02	1/4	1/4	H: Grommet (600 mm)	●	●	×
	3	03	3/8	3/8	D: DIN terminal	●	●	●
		04	1/2	1/2	DO: DIN terminal (Without connector)	●	●	×
	5	04	1/2	1/2	G: Grommet (300 mm)	●	●	×
		06	3/4	3/4	H: Grommet (600 mm)	●	●	×
		10	1	1				
		12	1 1/4	1 1/4				
	7	14	1 1/2	2	D: DIN terminal	●	×	●
		20	2					
Base mounted	2	Nil	Without sub-plate		G: Grommet (300 mm)	●	●	×
		01	1/8	1/8	H: Grommet (600 mm)	●	●	×
		02	1/4	1/4	D: DIN terminal	●	●	●
		02	1/4	1/4	DO: DIN terminal (Without connector)	●	●	×

Note 4) Face seal type One-touch fittings cannot be used.

⚠ Caution

- Be sure to read this before handling the products.
- Refer to back page 50 for Safety Instructions and pages 3 to 9 for 3/4/5 Port Solenoid Valve Precautions.

Application Example

1. Relief regulator (Rapid tank internal pressure setting)

(Relieving type regulator e.g. AR-D)

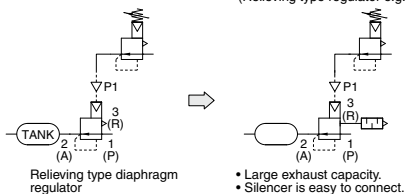

2. Air blow (As 2 port directional control regulator valve)

(AR-D, etc.)

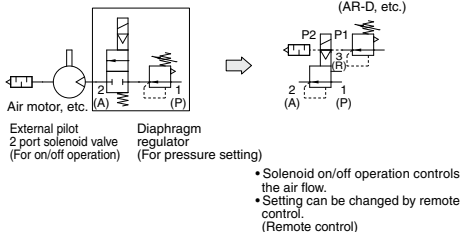

3. Constant pressure supply and driving (As 3 port directional control regulator valve)

Note) The pressure is about 0.01 MPa when OFF because of leakage.

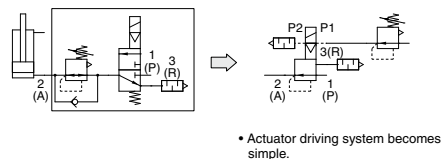
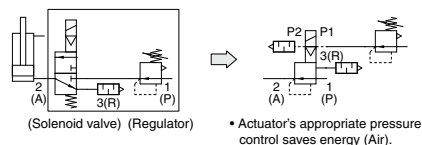

4. Balance and driving

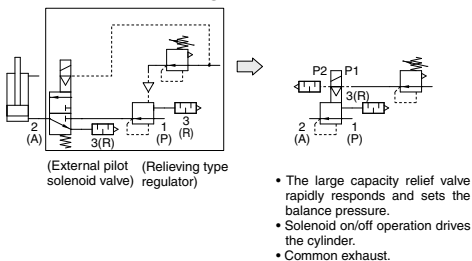

5. 2 steps directional control setting

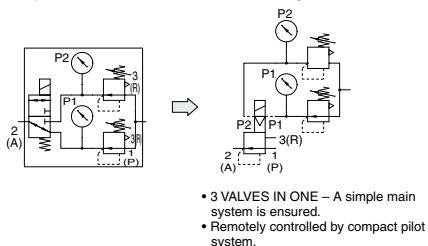

6. Multiple steps pressure control (Toward stepless control)

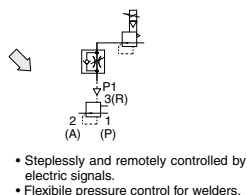
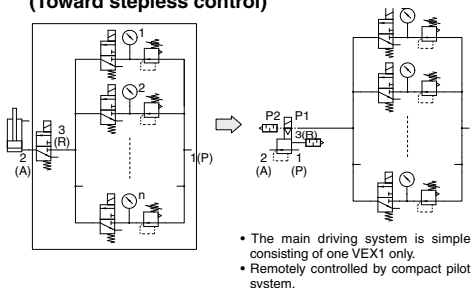

⚠ Caution

- When the VEX outlet side capacity is small, install a speed controller AS2000, in the pilot pipe to lower the pilot pressure for vibration prevention. (Meter-in)

⚠ Caution ((5) 2 steps directional control setting, (6) multiple steps pressure control setting)

- Relieving type regulator such as AR-D, etc. should be used as pilot regulator in the application. (When the non-relieving type is used, pressure cannot be changed from high to low.)
- A sensitive regulator such as the ARP30, etc. should be used as a pilot regulator on the low pressure side, particularly with 5. 2 steps directional control setting and 6. multiple steps pressure control. (Using a non-sensitive regulator may cause unstable pressure.)

Flow Rate Characteristics

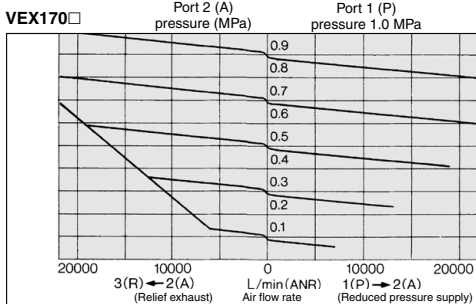
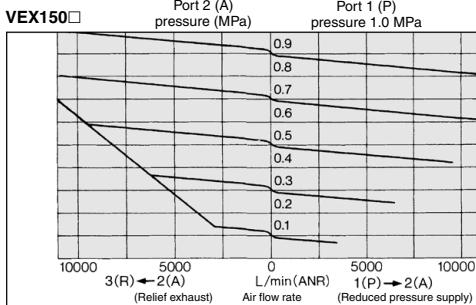
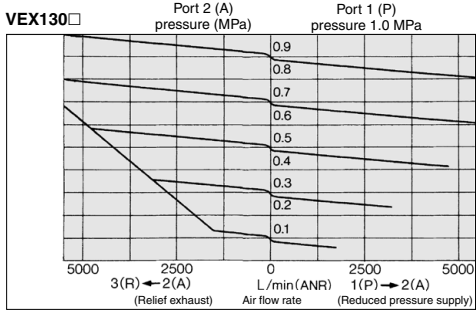
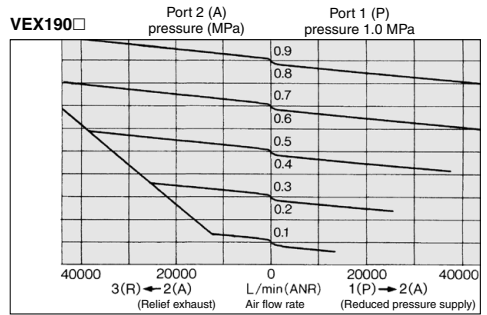
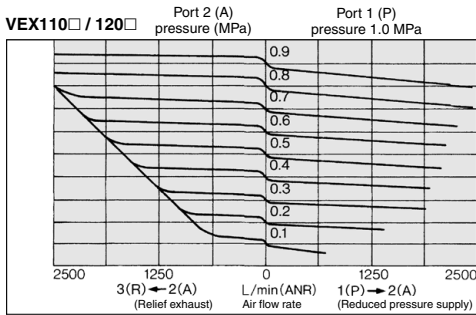

Setting Pressure Characteristics

Port P1 pressure is set according to port 2 (A) pressure.

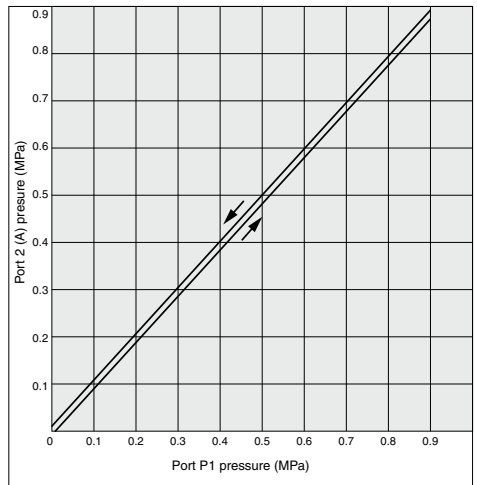

External Pilot Piping

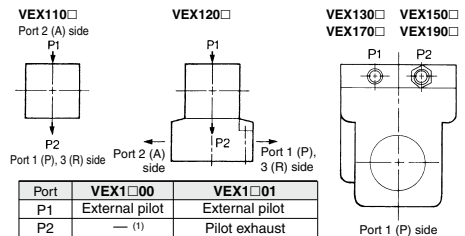

Note 1) Port P2 is not compatible with VEX1□00.
 Note 2) A silencer is mounted to port P2 for VEX1 3/5/7/9 01 as a standard. For the 2 steps directional control and multiple steps pressure control setting, use the product after removing a silencer.

VEX

VEX1 Series

Pressure Characteristics

Shows the outlet pressure (Port 2 (A)) change against the inlet pressure (Port 1 (P)) change. They conform to JIS B 8372 (Air pressure regulator).

VEX110□ / 120□

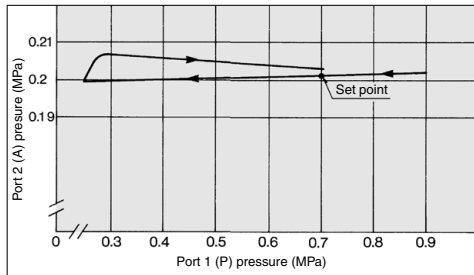

VEX130□

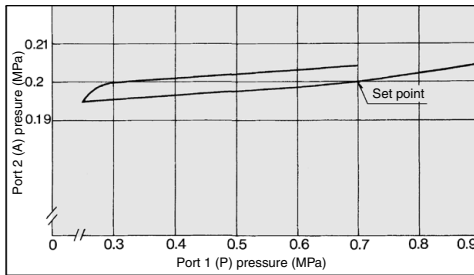

VEX150□

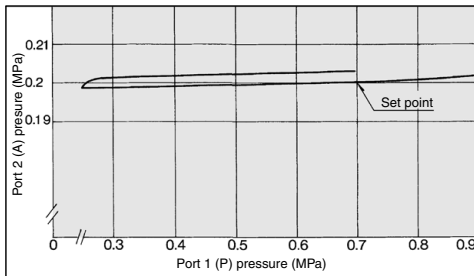

VEX170□

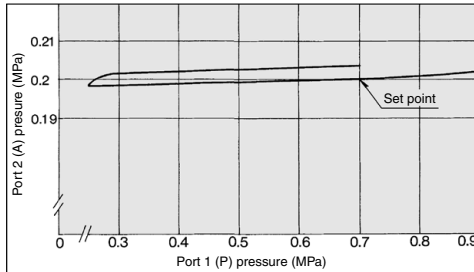

VEX190□

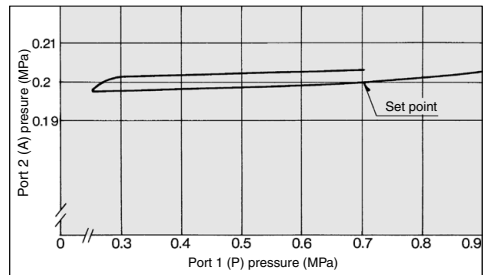

Relief Time

1. Relief time from 0.5 MPa to 0.1 MPa

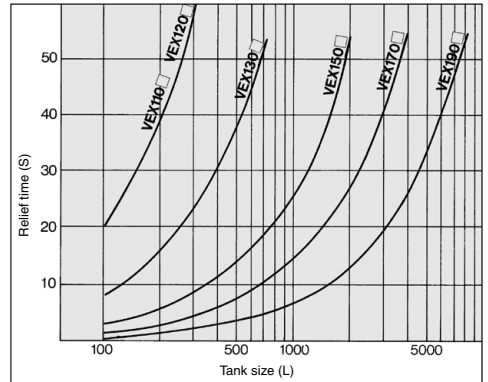

2. Relief time from 1000 L tank

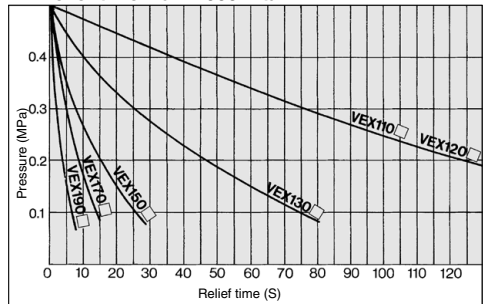

3. Relief time from an arbitrary pressure

[Example] VEX 1500 lowers 2000 L tank from 0.4 MPa to 0.1 MPa:

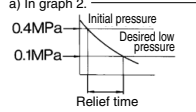
- a) In graph 2. 
- b) The relief time for the 2000 L tank is found by conversion as shown below.
- $$t = \frac{\text{Tank capacity}}{1000} \times \left[\frac{\text{Relief time}}{\text{that is read}} \right]$$
- $$= \frac{2000}{1000} \times 23$$
- $$= 46$$
- From above, the relief time is 26 - 3 = 23 s
- The result is 46 s.

Construction/Working Principle/Component Parts

(1) When Port 2 (A) pressure is high Relief exhausting

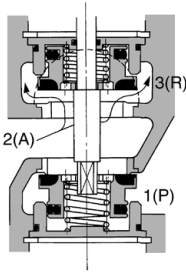

(2) Setting pressure condition

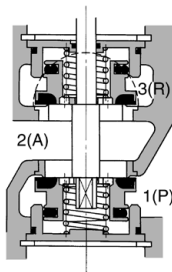

(3) When Port 2 (A) pressure is low Pressure reducing supply

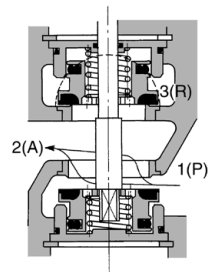

- The balance between the acting force F_1 of the pilot pressure (port P1) over the upper surface of the pressure regulating piston ③ and the acting force F_2 of the pressure at port 2 (A) leading to a space under the piston through the feed back flow root closes a couple of poppet valves ⑥ and sets port 2 (A) pressure that corresponds to port P1 pressure. The poppet valves are backed up by spring ④ - in the pressure balance structure by means of port 2 (A) pressure. (DRW (2))
- When port 2 (A) pressure exceeds port P1 pressure, F_2 becomes larger than F_1 , and the pressure regulating piston moves upward, opening the upper poppet valves. Thus air is released from port 2 (A) to port 3 (R) (DRW (1)). When port 2 (A) pressure lowers enough to restore the balance with port P1 pressure, the regulator valve returns again to the DRW (2) condition.
- When port 2 (A) pressure is lower than port P1 pressure, F_1 becomes larger than F_2 , and the pressure regulating piston moves downwards, opening the lower poppet valves. Thus air is supplied from port P1 to port 2 (A) (DRW (3)). When port 2 (A) pressure rises enough to restore the balance with port P1 pressure, the regulator valve returns again to the DRW (2) condition.

**(Air operated)
VEX1100**

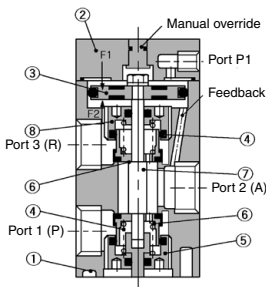

**(Air operated)
VEX1200**

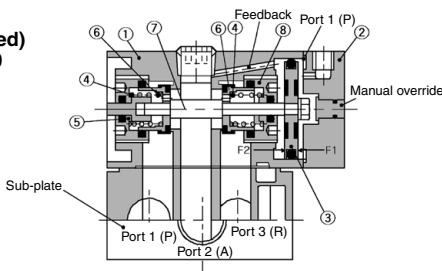

**(Air operated)
VEX1300/1500/1700/1900**

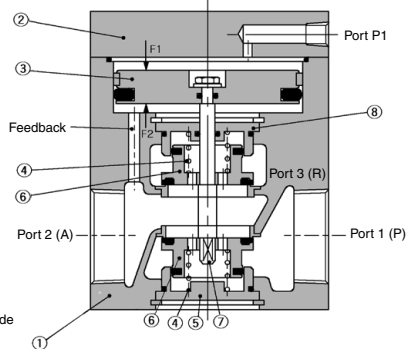

VEX

No.	Description	Material
1	Body	Aluminum alloy casted
2	Cover	Aluminum alloy casted
3	Regulation piston	Aluminum alloy
4	Spring	Stainless steel
5	Valve guide	Aluminum alloy
6	Poppet valve	Aluminum alloy, Rubber
7	Shaft	Stainless steel
8	Valve guide	Aluminum alloy

Dimensions

Air operated: VEX1300
External pilot solenoid: VEX1301

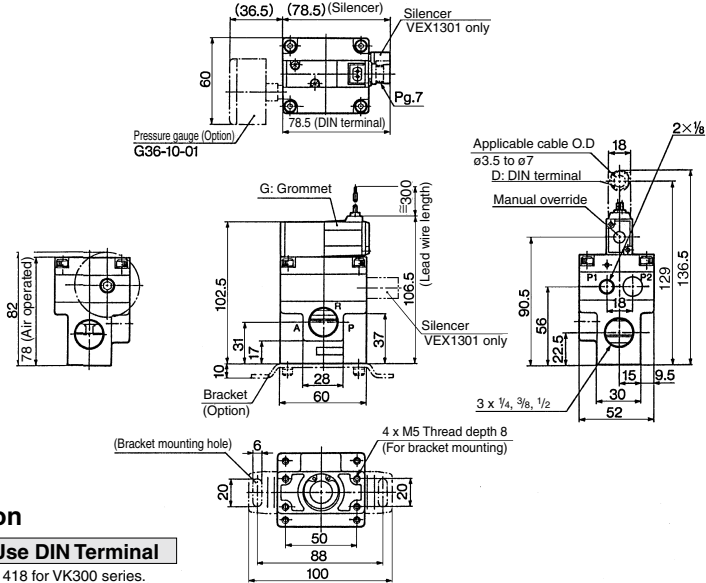

Caution

How to Use DIN Terminal

Refer to page 1418 for VK300 series.

Air operated: VEX1500
External pilot solenoid: VEX1501

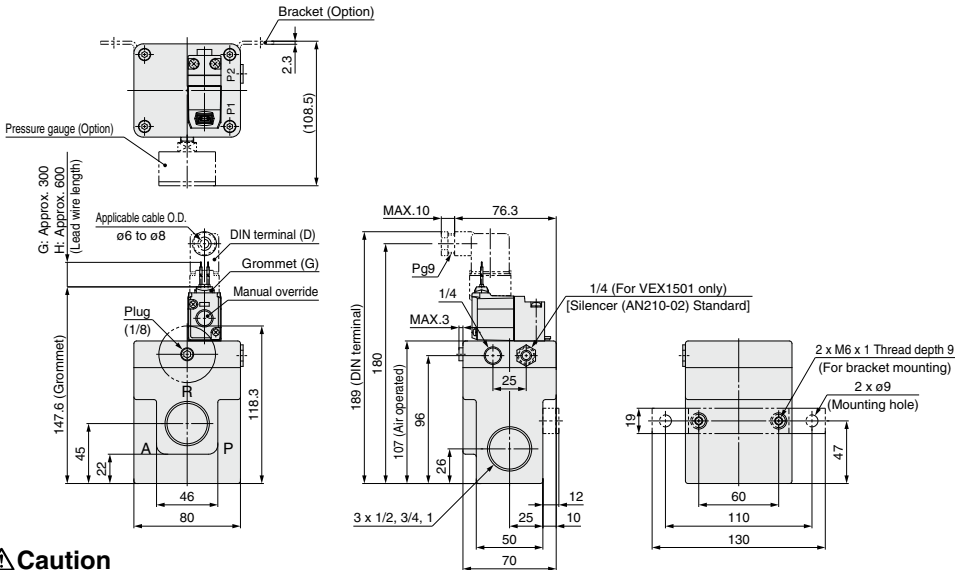

Caution

How to Use DIN Terminal

Refer to page 1435 for VT307 series.

VEX1 Series

Dimensions

Air operated: VEX1700 External pilot solenoid: VEX1701

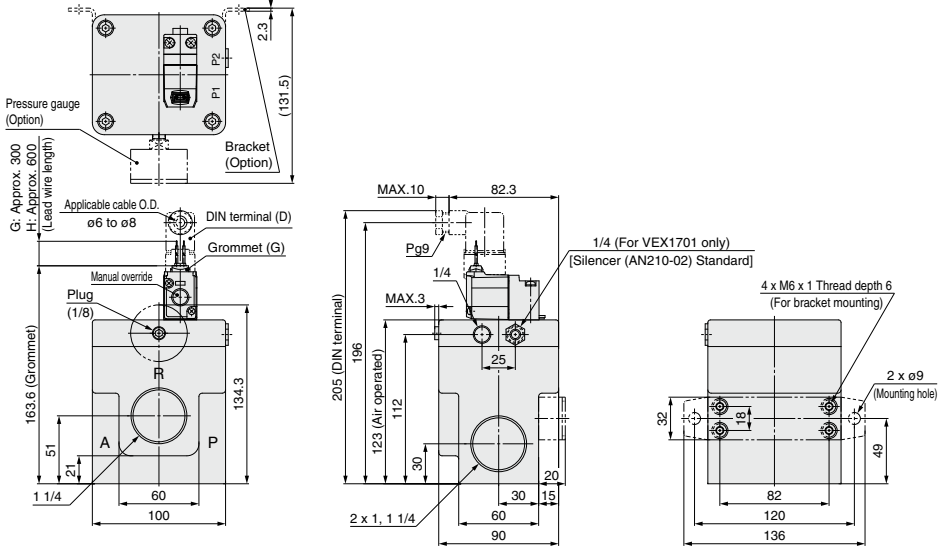

Air operated: VEX1900 External pilot solenoid: VEX1901

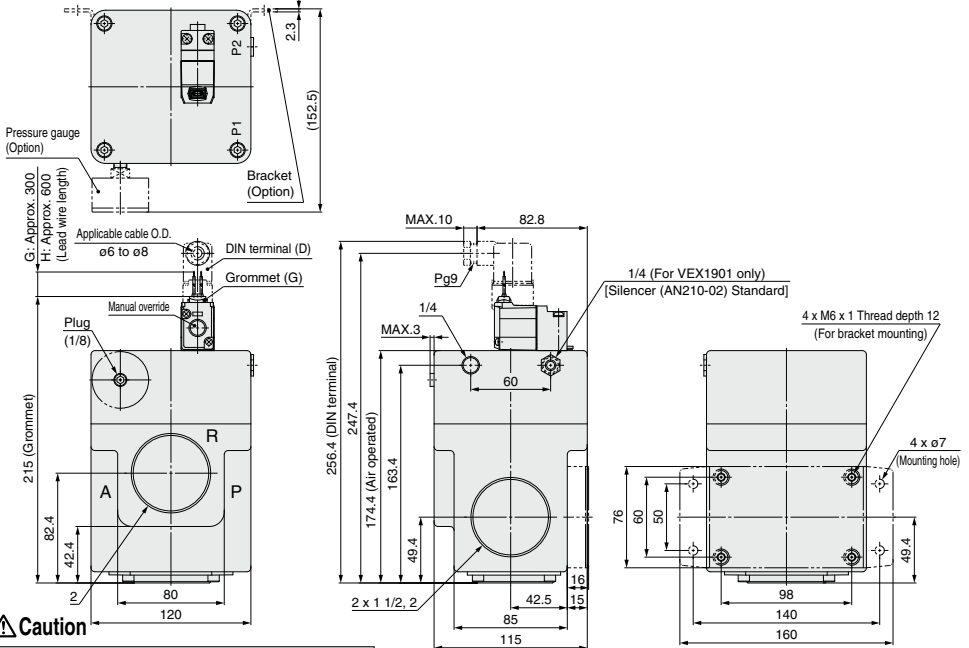

How to Use DIN Terminal

Refer to page 1435 for VT307 series.

VEX1 Series Manifold Specifications

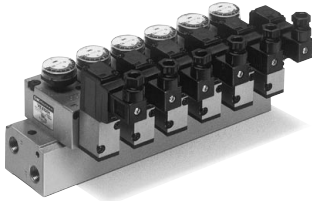

Specifications

Valve stations	2 to 8 ⁽¹⁾
Port specifications	Common SUP, EXH
Port size (Port 1 (P), 2 (A), 3 (R))	Rc, NPTF, G, NPT 1/4
Applicable valve	VEX1200/1201 ⁽²⁾
Applicable blanking plate	VEX1-17 (With gasket and bolts)

Note 1) If there are more than 5 stations, apply pressure from port 1(P) on both sides and exhaust from port 3 (R) on both sides.

Note 2) VEX1200 (air operated) and VEX1201 (external pilot solenoid) are both individual external pilot type. The port P1 on the valve is used as a pilot port, but not the P1 hole on the manifold base.

How to Order

External Pilot Piping

Valve port	Type	Air operated	External pilot solenoid valve
Applicable valve		VEX1200	VEX1201
P1	External pilot	External pilot	External pilot
P2	— ^{Note)}	—	Pilot exhaust

Note) Port P2 is not available for VEX 1200

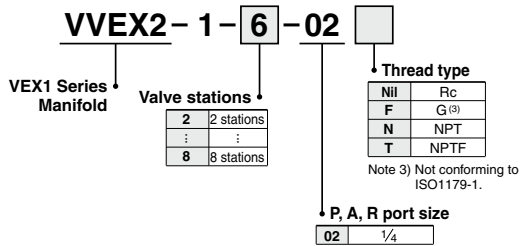
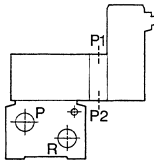

How to Order Manifold

Specify the part numbers for the regulator valve and blanking plates starting from the left of manifold base (After making the port 2 (A) face the front).

(Ex.) VVEX2-1-5-02N.....1 5 station manifold base, Port thread NPT

* VEX1201-5DZ-G.....4 Regulator valve, External pilot solenoid valve, 24 VDC, DIN terminal, with light/surge voltage suppressor, Option... with pressure gauge^{Note)}

* VEX1-17.....1 Blanking plate

Note) In the case of manifold, pressure gauge: G27-10-01 only (O.D. ø26)

Dimensions

VVEX2-1-1-Station-02

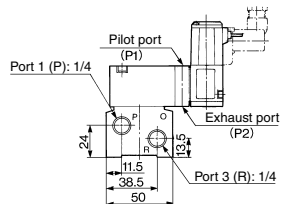
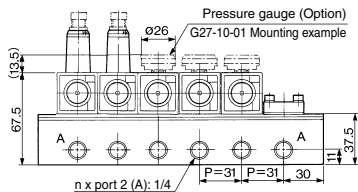
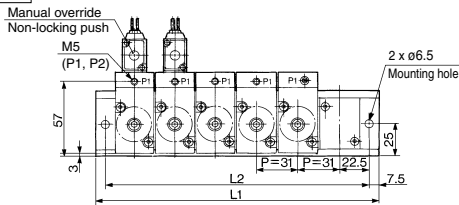

	n	2	3	4	5	6	7	8	n: Station
L1	91	122	153	184	215	246	277	277	L1 = 31 x n + 29
L2	76	107	138	169	200	231	262	262	L2 = 31 x n + 14

Power Valve: 3 Position Valve

VEX3 Series

The body sizes 12/22/32/42 have been remodeled. For details, refer to page 1721.

Realize a variety of circuits using simple components.

Intermediate and emergency stops of large-sized cylinders

Intermediate and emergency cylinder stops

The 3 position closed center valve produces a simple and large capacity system.

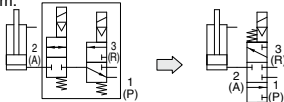

- A large capacity system without connection loss.

$\frac{1}{1} = \frac{1}{0.71}$ (Valves and piping can be made smaller.)

Terminal deceleration and an intermediate speed change circuit can be produced easily.

The simple system configuration permits sharp response. The large capacity system configuration without connection loss allows the use of smaller valves and piping.

- For example, when solenoid (b) of valve (A) is turned off while the cylinder is extending, the exhaust port closes and cylinder movement decelerates.

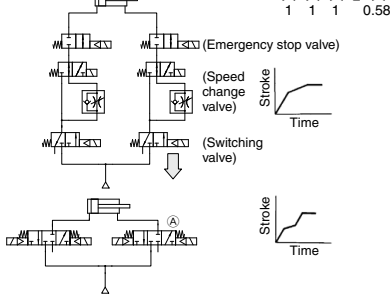

Universal porting could be used as a selector/divider valve

The pressure balancing poppet valve that permits any flow direction allows sequential switching operation, preventing blow by and air entrainment.

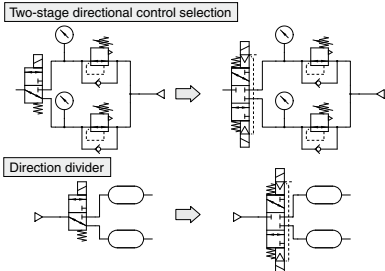

System configuration when using VEX

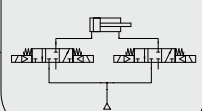

Current system configuration

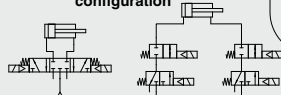

- There were not many suitable large capacity 5 support valves available with a 3 position closed center.
- There were not many suitable 2-port valves for stopping.

Vacuum suction and release

The 3 port, 3 position double solenoid that permits vacuum suction, release, and suspension (closed) is ideal for a system where many valves are used.

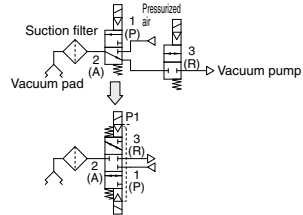

- There is no blow-by when switched from vacuum suction to vacuum release or vice versa.
- When maintaining the vacuum of port 2 (A), the vacuum may decrease due to leakage from the vacuum pad or piping. Conduct vacuum suction at the vacuum adsorption position. Furthermore, it cannot be used as an emergency cutoff valve.

Caution

For operation control of double acting cylinders

Two power valves driven by a double acting cylinder allows operation control in 9 positions (3 positions x 3 positions = 9 positions) including slow stopping, acceleration, and deceleration.

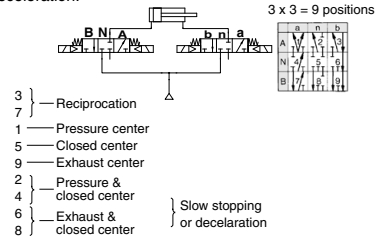

Caution

- This valve is not a non-leak specification, and thus cannot be used for long term intermediate stops or emergency stops.

VEX3 Series

Please assume the chart is offered as the guideline. For details about various each condition, please make use of SMC Model Selection Software and then decide it.

Cylinder Speed Chart

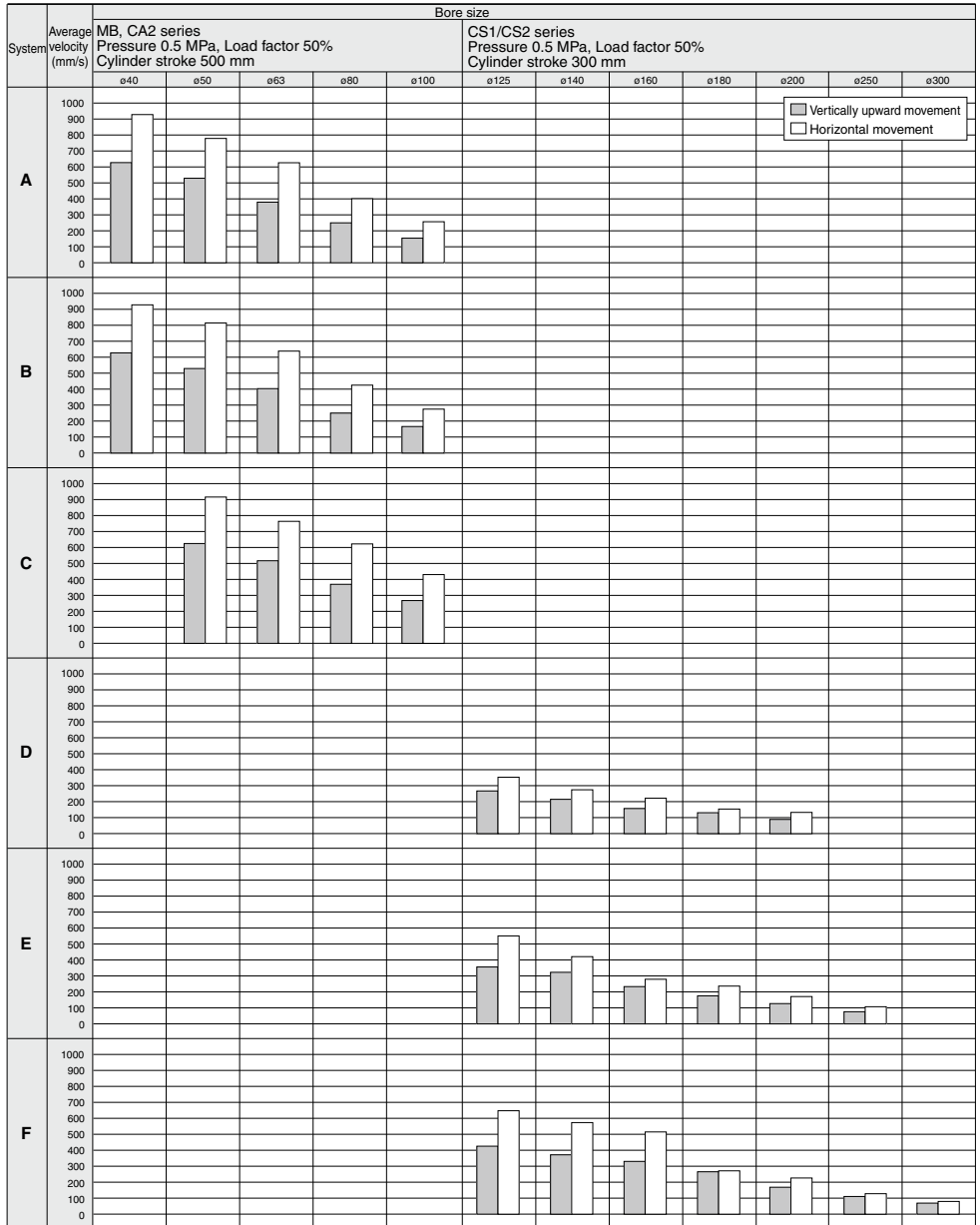

* When the cylinder is extended, the speed controller is metered-out, is connected with the cylinder directly, and its needle is fully open.

* Values on the average velocity of a cylinder are obtained from the stroke length divided by full stroke time.

* Load proportion is $((\text{load weight} \times 9.8) / \text{theoretical force}) \times 100\%$

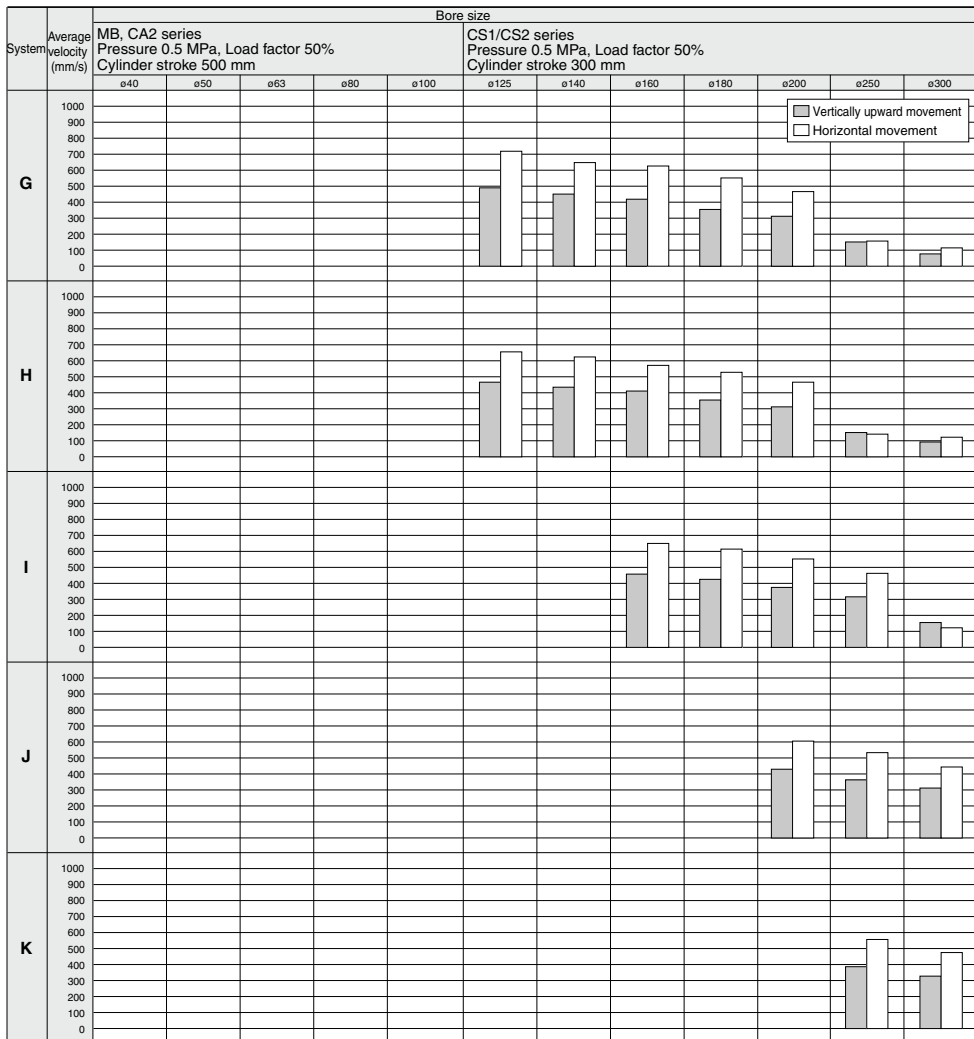

* When the cylinder is extended, the speed controller is metered-out, is connected with the cylinder directly, and its needle is fully open.
 * Values on the average velocity of a cylinder are obtained from the stroke length divided by full stroke time.
 * Load proportion is ((load weight x 9.8)/theoretical force) x 100%

Conditions of Speed Chart

System	Solenoid valve	Speed controller	Silencer	Tubing diameter x Length		
A	VEX3 $\frac{1}{2}$ 2□-02	AS4000-02	AN20-02	ø10 x 1 m		
B				ø12 x 1 m		
C	VEX3 $\frac{3}{4}$ 2□-03	AS420-03	AN30-03	ø12 x 1 m		
D				SGP15A x 1 m		
E	VEX350 □-06	AS420-04	AN40-04	SGP15A x 1 m		
F				AS500-06	AN500-06	SGP20A x 1 m
G				AS600-10	AN600-10	SGP25A x 1 m
H	VEX370 □-10	AS600-10	AN600-10	SGP25A x 1 m		
I		AS800-12	AN700-12	SGP32A x 1 m		
J	VEX390 □-14	AS900-14	AN800-14	SGP40A x 1 m		
K		AS900-20	AN900-20	SGP50A x 1 m		

The body sizes 12/22/32/42 have been remodeled. For details, refer to page 1721.

How to Order



Body size	Port size ⁽¹⁾		
	Port	1 (P), 2 (A)	3 (R)
12	01	1/8	
	02	1/4	
32	02	1/4	
	03	3/8	
50	04	1/2	
	04	1/2	
	06	3/4	
70	10	1	
	10	1	1 1/4
	12	1 1/4	
90	14	1 1/2	
	20	2	

Electrical entry (Only with solenoid)

Body size	Symbol	Electrical entry (Only with solenoid)	Electrical entry (Only with solenoid)		
			NII	S	Z
12 32	G	Grommet, Lead wire length 300 mm	●	●	×
	H	Grommet, Lead wire length 600 mm	●	●	×
	L	L plug connector, Lead wire length 300 mm	●	●	●
	LN	L plug connector, Without lead wire	●	●	●
	LO	L plug connector, Without connector	●	●	●
	M	M plug connector, Lead wire length 300 mm	●	●	●
	MN	M plug connector, Without lead wire	●	●	●
	MO	M plug connector, Without connector	●	●	●
	D	DIN terminal	●	●	●
	DO	DIN terminal, Without connector	●	●	×
50 70 90	G	Grommet, Lead wire length 300 mm	●	●	×
	H	Grommet, Lead wire length 600 mm	●	●	×
	D	DIN terminal	●	×	●

Body ported

VEX3 12 0 - 01 [] 5 D [] - B

Base mounted

VEX3 22 0 - 01 [] 5 D [] - B



Operation type

0	Air operated
1	External pilot solenoid
2	Internal pilot solenoid

Option

(Only bracket or foot may be mounted.)

NII	None
B	Bracket ⁽⁴⁾
F	Foot (VEX312□ and VEX332□ only)
N	Silencer for pilot exhaust (P2) port (Only with solenoid)

Note 4) Except VEX322□, VEX332□ and VEX342□

Light/Surge voltage suppressor

	None
S	With surge voltage suppressor (Grommet only for a body size of 50 or more)
Z	With light/surge voltage suppressor (Except grommet)

Body size	Port size ⁽¹⁾		
	Port	1 (P), 2 (A)	3 (R)
22	NII	Without sub-plate	
	01	1/8	
	02	1/4	
42	NII	Without sub-plate	
	02	1/4	
	03	3/8	
	04	1/2	

Note 1) Face seal type One-touch fittings cannot be used.

Thread type

NII	Rc
F	G ⁽²⁾
N	NPT
T	NPTF

Note 2) Not conforming to ISO1179-1.

Rated voltage (Only with solenoid)

1	100 VAC (50/60 Hz)
2	200 VAC (50/60 Hz)
3	110 VAC (50/60 Hz)
4	220 VAC (50/60 Hz)
5	24 VDC
6	12 VDC
7	240 VAC (50/60 Hz)

For other rated voltages, please consult with SMC.

Electrical entry⁽³⁾ (Only with solenoid)

Symbol	Electrical entry (Only with solenoid)	Electrical entry (Only with solenoid)		
		NII	S	Z
G	Grommet, Lead wire length 300 mm	●	●	×
H	Grommet, Lead wire length 600 mm	●	●	×
L	L plug connector, Lead wire length 300 mm	●	●	●
LN	L plug connector, Without lead wire	●	●	●
LO	L plug connector, Without connector	●	●	●
M	M plug connector, Lead wire length 300 mm	●	●	●
MN	M plug connector, Without lead wire	●	●	●
MO	M plug connector, Without connector	●	●	●
D	DIN terminal	●	●	●
DO	DIN terminal, Without connector	●	●	×

Note 3) Refer to page 1768 for individual part numbers of plug and DIN connectors. (Common with VZ series)

Sub-plate and base gasket part no.

Valve size	2	4																																																
Sub-plate	<p>VEX1-9-1 [] [] P</p> <table border="1"> <thead> <tr> <th colspan="2">Port size</th> <th colspan="2">Thread type</th> </tr> <tr> <th>Symbol</th> <th>Port size</th> <th>Symbol</th> <th>Thread type</th> </tr> </thead> <tbody> <tr> <td>A</td> <td>1/8</td> <td>NII</td> <td>Rc</td> </tr> <tr> <td>B</td> <td>1/4</td> <td>F</td> <td>G</td> </tr> <tr> <td></td> <td></td> <td>N</td> <td>NPT</td> </tr> <tr> <td></td> <td></td> <td>T</td> <td>NPTF</td> </tr> </tbody> </table>	Port size		Thread type		Symbol	Port size	Symbol	Thread type	A	1/8	NII	Rc	B	1/4	F	G			N	NPT			T	NPTF	<p>VEX4-2A- [] [] P</p> <table border="1"> <thead> <tr> <th colspan="2">Port size</th> <th colspan="2">Thread type</th> </tr> <tr> <th>Symbol</th> <th>Port size</th> <th>Symbol</th> <th>Thread type</th> </tr> </thead> <tbody> <tr> <td>A</td> <td>1/8</td> <td>NII</td> <td>Rc</td> </tr> <tr> <td>B</td> <td>3/8</td> <td>F</td> <td>G</td> </tr> <tr> <td>C</td> <td>1/2</td> <td>N</td> <td>NPT</td> </tr> <tr> <td></td> <td></td> <td>T</td> <td>NPTF</td> </tr> </tbody> </table>	Port size		Thread type		Symbol	Port size	Symbol	Thread type	A	1/8	NII	Rc	B	3/8	F	G	C	1/2	N	NPT			T	NPTF
Port size		Thread type																																																
Symbol	Port size	Symbol	Thread type																																															
A	1/8	NII	Rc																																															
B	1/4	F	G																																															
		N	NPT																																															
		T	NPTF																																															
Port size		Thread type																																																
Symbol	Port size	Symbol	Thread type																																															
A	1/8	NII	Rc																																															
B	3/8	F	G																																															
C	1/2	N	NPT																																															
		T	NPTF																																															
Base gasket	VEX1-11-2	VEX4-4																																																

Caution

Be sure to read this before handling the products.
Refer to back page 50 for Safety Instructions and pages 3 to 9 for 3/4/5 Port Solenoid Valve Precautions.

Variety of circuits in simple construction

3 position valve suitable for intermediate and emergency stop of large size cylinder.

System construction with VEX

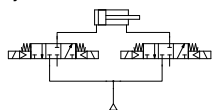

Current system construction

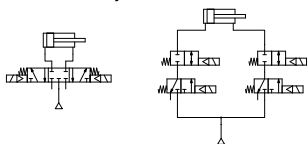

- There were not many suitable large capacity 5 port valves available with a 3 position closed center.
- There were not many suitable large capacity 2 port valves available for stopping operations.

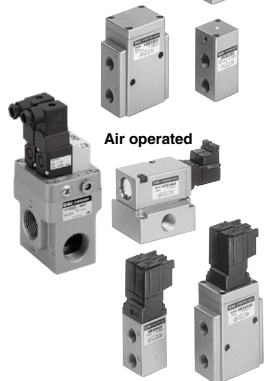

Air operated

Specifications

Model	Body ported	VEX312□-01/02	VEX332□-02/03/04	VEX350□-04/06/10	VEX370□-10/12	VEX390□-14/20
	Base mounted	VEX322□-01/02	VEX342□-02/03/04	—	—	—
Operation type		Air operated, External pilot solenoid, Internal pilot solenoid				
Fluid		Air				
Pressure range	Air operated	Main pressure Low vacuum to 1.0 MPa				
	External pilot solenoid	External pilot pressure 0.2 to 1.0 MPa				
	Internal pilot solenoid	Main pressure Low vacuum to 1.0 MPa				
Ambient and fluid temperature	External pilot solenoid	External pilot pressure 0.2 to 0.7 MPa	External pilot pressure 0.2 to 0.9 MPa			
	Internal pilot solenoid	Main pressure 0.2 to 0.7 MPa	Main pressure 0.2 to 0.9 MPa			
Response time (Pilot pressure 0.5 MPa)		40 ms or less	60 ms or less			
Max. operating frequency		3 cycles/sec.				
Mounting		Free				
Lubrication		Not required (Use turbine oil Class 1 ISO VG32, if lubricated.)				

Note) Non-lubricated specifications are not available for this product.

Pilot Solenoid Valve Specifications

Model	VEX3121, VEX3221, VEX3321, VEX3421 VEX3122, VEX3222, VEX3322, VEX3422	VEX3501, VEX3701, VEX3901 VEX3502, VEX3702, VEX3902
Pilot valve	Exclusive pilot valve	VO307K-□□□1
Electrical entry	Grommet, L plug connector, M plug connector, DIN terminal	Grommet, Grommet terminal, Conduit terminal, DIN terminal
Coil rated voltage (V)	AC(50/60Hz) DC	100V, 110V, 200V, 220V, 240V 6V, 12V, 24V, 48V
Temperature rise		-15 to +10% of rated voltage
Apparent power	AC	Inrush 4.5 VA/50 Hz, 4.2 VA/60 Hz Holding 3.5 VA/50 Hz, 3 VA/60 Hz
	DC	12.7 VA (50 Hz), 10.7 VA (60 Hz) 7.6 VA (50 Hz), 5.4 VA (60 Hz)
Power consumption	DC	1.8 W (Without indicator light), 2.1 W (With indicator light) 4 W (Without indicator light), 4.2 W (With indicator light)
Manual override		Non-locking push type Non-locking push type

Note) When replacing the pilot valves specified for valve sizes 1 to 4, please request SMC to replace them at the factory.

Option

Description		Part no.						
		VEX312□-01/02	VEX322□-01/02	VEX332□-02/03/04	VEX342□-02/03/04	VEX350□-04/06/10	VEX370□-10/12	VEX390□-14/20
Bracket (With bolt and washer)	B	VEX1-18-1A	—	—	—	VEX5-32A	VEX7-32A	VEX9-32A
Foot (With bolt and washer)	F	VEX1-18-2A	—	VEX3-32-2A	—	—	—	—
Pilot exhaust port P2 silencer <small>Note)</small>	N	AN120-M5			AN210-02			

Note) Only with solenoid.

Weight

(kg)

Model	VEX312□-01/02	VEX322□-01/02	VEX332□-02/03/04	VEX342□-02/03/04	VEX350□-04/06/10	VEX370□-10/12	VEX390□-14/20
Air operated	0.1	0.2	0.3	0.6	1.4	2.1	3.3
Solenoid	0.2	0.3	0.4	0.7	1.6	2.3	3.5

VEX

Internal pilot solenoid/External pilot solenoid

Symbol

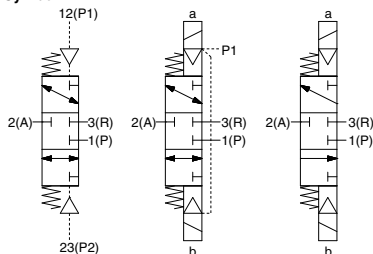

Air operated External pilot solenoid Internal pilot solenoid

VEX3 Series

Flow Rate Characteristics

Model	Port size	Flow rate characteristics												
		1 (P) → 2 (A)			2 (A) → 1 (P)			3 (R) → 2 (A)			2 (A) → 3 (R)			
		C _d (dm ³ /s·bar)	b	C _v	C _d (dm ³ /s·bar)	b	C _v	C _d (dm ³ /s·bar)	b	C _v	C _d (dm ³ /s·bar)	b	C _v	
Body ported	VEX312□-01	1/8	2.4	0.19	0.59	2.4	0.31	0.59	2.3	0.36	0.59	2.5	0.22	0.61
	VEX312□-02	1/4	3.5	0.35	0.89	3.3	0.49	0.89	3.1	0.46	0.89	3.5	0.33	0.93
	VEX332□-02	1/4	4.1	0.36	1.1	4.3	0.42	1.1	4.1	0.41	1.1	4.6	0.25	1.2
	VEX332□-03	3/8	8.7	0.29	2.2	7.9	0.52	2.2	7.8	0.51	2.4	8.7	0.33	2.4
	VEX332□-04	1/2	9.8	0.37	2.7	9.6	0.52	2.7	9.1	0.53	3.0	11	0.37	3.0
Base mounted (With sub-plate)	VEX350□-01	1/2	24	0.32	6.4	24	0.30	6.4	25	0.31	6.4	22	0.27	5.7
	VEX322□-01	1/8	3.3	0.34	0.86	3.5	0.39	0.86	3.3	0.37	0.86	3.5	0.36	0.87
	VEX322□-02	1/4	4.1	0.28	0.99	4.1	0.39	0.99	3.8	0.38	0.97	4.4	0.23	1.1
	VEX342□-02	1/4	8.1	0.34	2.0	7.9	0.39	2.0	8.2	0.33	2.1	8.1	0.37	2.2
	VEX342□-03	3/8	12	0.26	3.2	12	0.29	3.2	12	0.28	3.1	13	0.28	3.3
VEX342□-04	1/2	13	0.20	3.3	13	0.24	3.3	12	0.29	3.2	14	0.20	3.3	

Model	Port size	Effective area (mm ²)	C _v	
Body ported	VEX350□-06	3/4	160	8.9
	VEX350□-10	1	180	10
	VEX370□-10	1	300	17
	VEX370□-12	1 1/4	330	18
	VEX390□-14	1 1/2	590	33
	VEX390□-20	2	670	37

External Pilot Piping

VEX312□

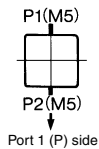

VEX322□

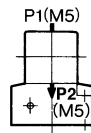

VEX350□

VEX370□
VEX390□

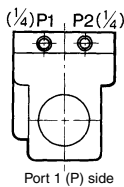

Port	VEX3□□0	VEX3□□1	VEX3□□2
P1	External pilot	External pilot	Plug
P2	External pilot	Pilot exhaust	Pilot exhaust

⚠ Caution

● VEX3³/₂ (Solenoid)

When the VEX3240 air operated power valve is delivered from our factory, the M5 threaded pilot port P2 in the cover is open and the 1/8 pilot port in the sub-plate is plugged. When port P2 on the body ^{Note} is used as a pilot exhaust port, remove the 1/8 plug and put the M5 plug into the pilot valve port P2 to cover it.

^{Note} Body for VEX332¹/₂, sub-plate for VEX342¹/₂

VEX3320
Air operated

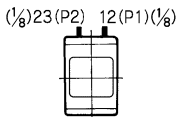

Port 1 (P), 3 (R) side

VEX3321
External pilot solenoid

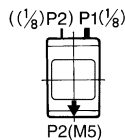

Port 1 (P), 3 (R) side

VEX3322
Internal pilot solenoid

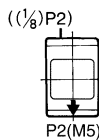

Port 1 (P), 3 (R) side

VEX3420
Air operated for sub-plate

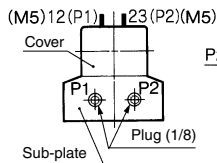

VEX3421
External pilot solenoid for subplate

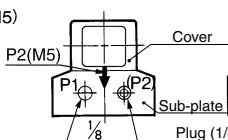

VEX3422
Internal pilot solenoid for subplate

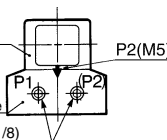

Body Ported: VEX312□

Air operated: VEX3120 External pilot solenoid: VEX3121 Internal pilot solenoid: VEX3122

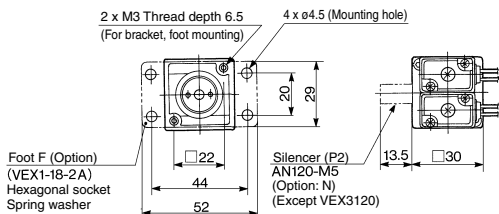

A perspective drawing

DIN terminal (D)

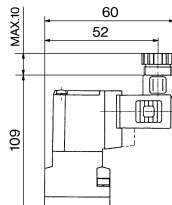
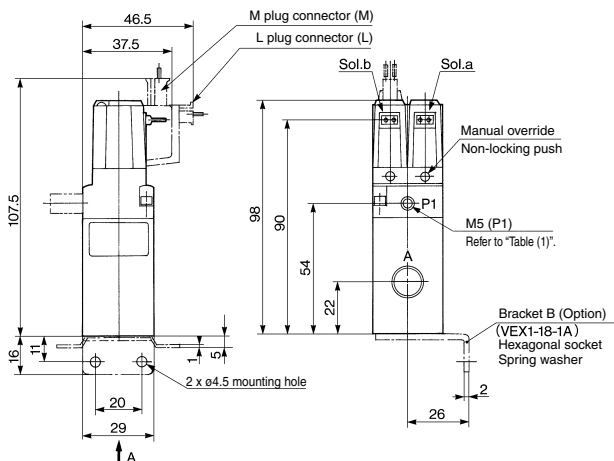
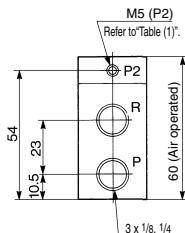

Table (1) With/Without Plug for M5 Port

Model	P1	P2
VEX3120	None	None
VEX3121	None	None
VEX3122	With plug	None



⚠ Caution

How to Use Plug Connector/Applicable Model: VEX312₂/322₂/332₂/342₂

Attaching/Detaching of a plug

1. To install the connector

Push the connector straight on the pins of the solenoid, making sure the lip of the lever is securely positioned in the groove on the solenoid cover.

2. To deinstall the connector

Press the lever against the connector and pull the connector away straight from the solenoid.

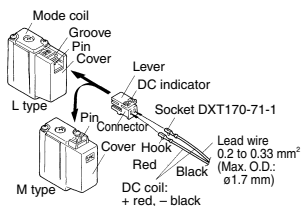

Crimping lead wire and socket

Peel 3.2 to 3.7 mm of the tip of the lead wire, enter the core wires neatly into a socket and press contact it with a press tool. Be careful so that the cover of lead wire does not enter into the core press contacting part. (Please contact SMC for the dedicated crimping tools.)

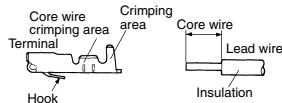

Attaching/Detaching of a socket with lead wire

1. Attaching

Insert a socket into the square hole (indicated at +, -) of connector, push fully the lead wire and lock by hanging the hook of a socket to the seat of connector. (Pushing in can open the hook and lock it automatically.) Then confirm the locking by lightly pulling on the lead wire.

2. Detaching

For pulling out a socket from connector, pull out the lead wire while pushing the hook of a socket with a stick with a fine point (1 mm). If a socket is to be re-used as it is, return the hook to the outside.

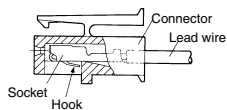

VEX

VEX3 Series

Base Mounted: VEX322□

Air operated: VEX3220 External pilot solenoid: VEX3221 Internal pilot solenoid: VEX3222

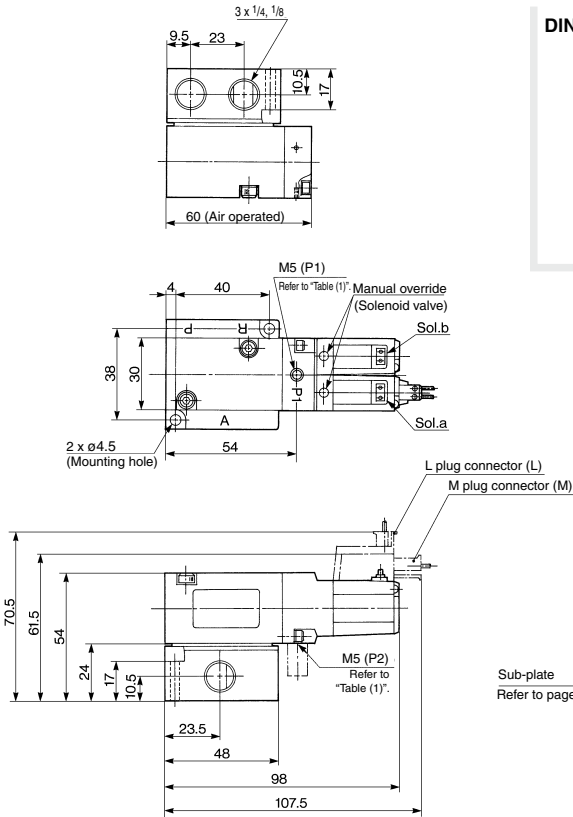

DIN terminal (D)

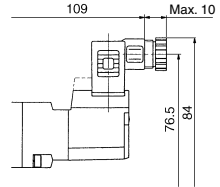
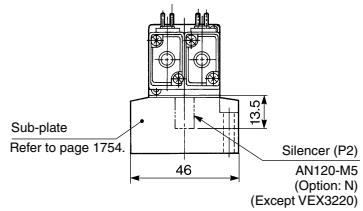

Table (1)
With/Without Plug for M5 Port

Model	P1	P2
VEX3220	None	None
VEX3221	None	None
VEX3222	With plug	None



⚠ Caution

How to Use DIN Terminal

Refer to page 1768.

Body Ported: VEX332□

Air operated: VEX3320 External pilot solenoid: VEX3321 Internal pilot solenoid: VEX3322

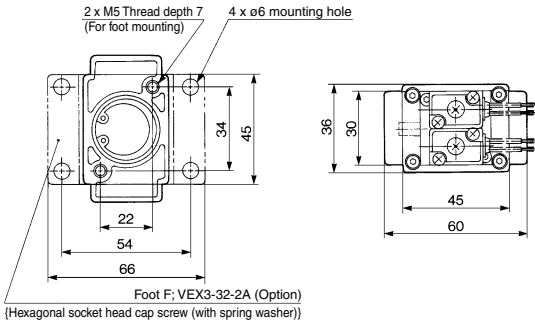

A perspective drawing

DIN terminal (D)

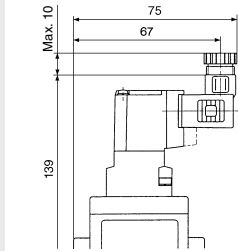

**Table (1)
With/Without Plug for 1/8 Port**

Model	P1	P2
VEX3320	None	None
VEX3321	None	With plug
VEX3322	With plug	With plug

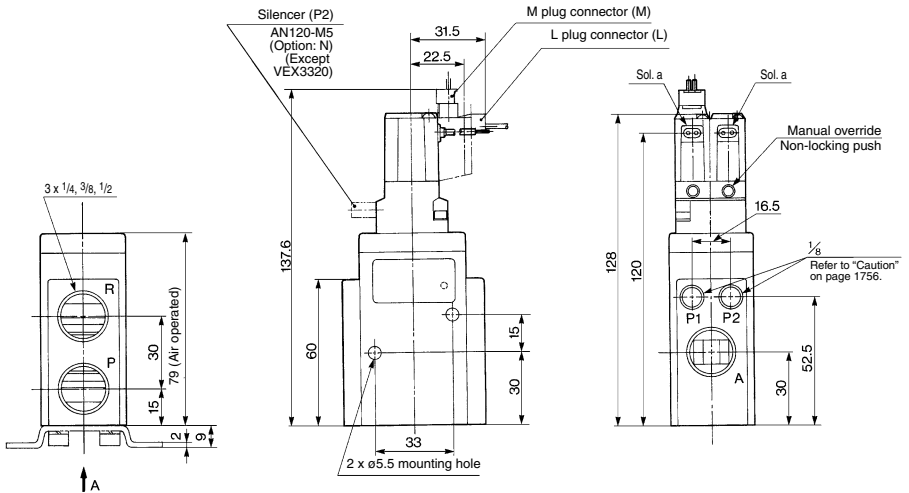

VEX

VEX3 Series

Base Mounted: VEX342□

Air operated: VEX3420 External pilot solenoid: VEX3421 Internal pilot solenoid: VEX3422

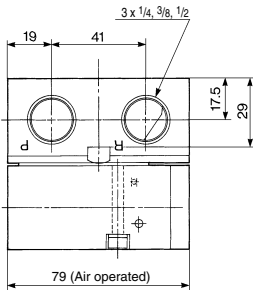

DIN terminal (D)

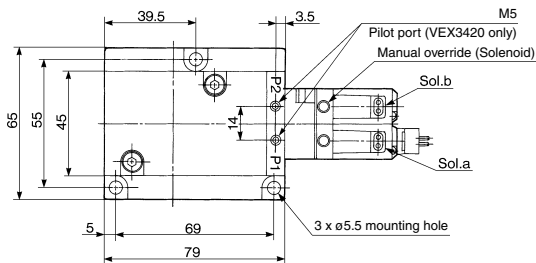
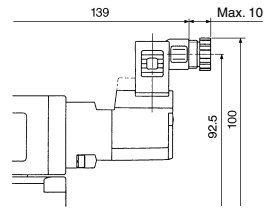
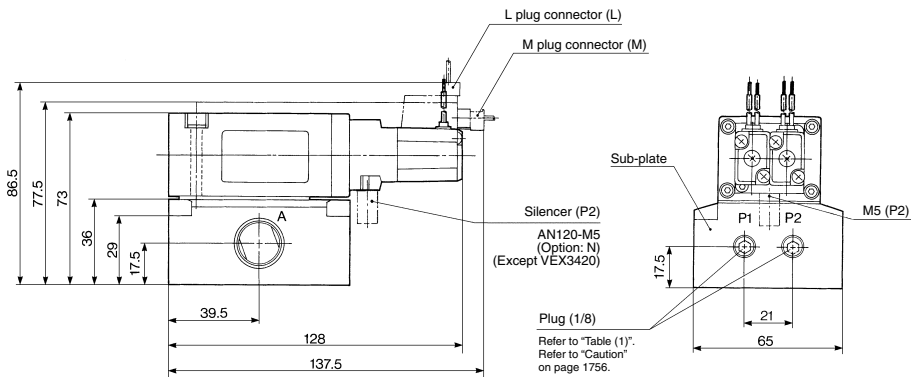

Table (1)

With/Without Plug for Sub-plate

Model	P1	P2
VEX3420	With plug	With plug
VEX3421	None	With plug
VEX3422	With plug	With plug



Body Ported: VEX350□/370□

Air operated: VEX3500
External pilot solenoid: VEX3501
Internal pilot solenoid: VEX3502

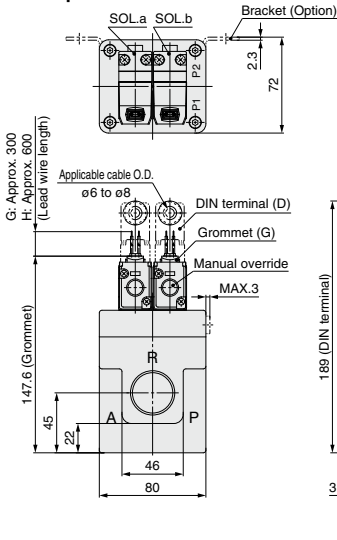

Air operated: VEX3700
External pilot solenoid: VEX3701
Internal pilot solenoid: VEX3702

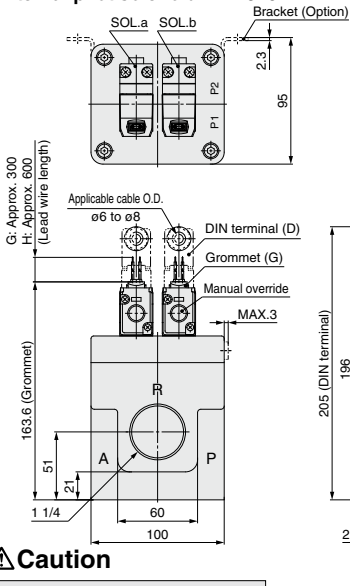

Table (1) With/Without Plug for 1/4 Port

Model	P1	P2
VEX3500	None	None
VEX3501	None	None
VEX3502	With plug	None

⚠ Caution

How to Use DIN Terminal

Refer to page 1435 for VT307 series.

VEX

VEX3 Series

Base Mounted: VEX390□

Air operated: VEX3900

External pilot solenoid: VEX3901

Internal pilot solenoid: VEX3902

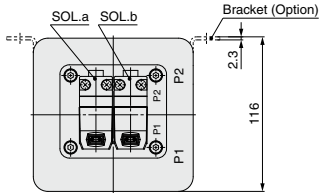
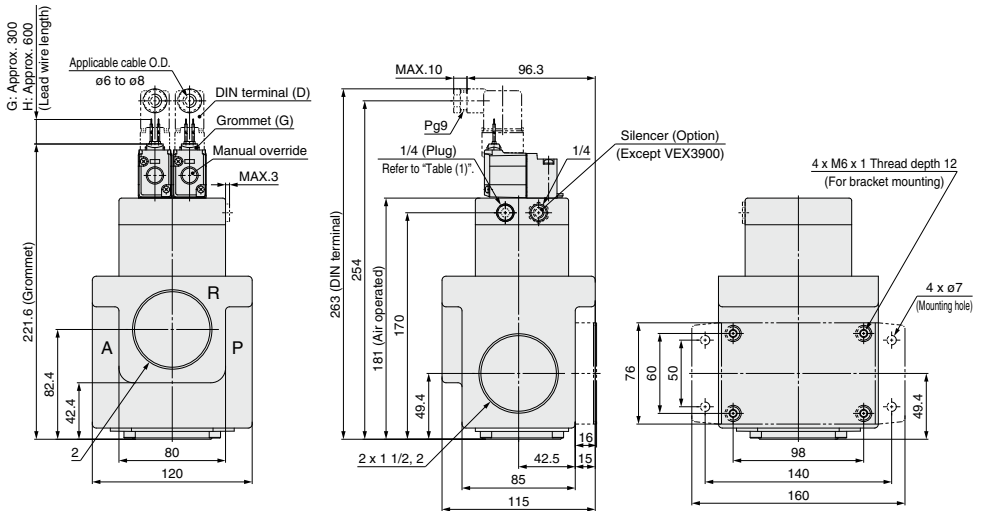

Table (1)
With/Without Plug for 1/4 Port

Model	P1	P2
VEX3900	None	None
VEX3901	None	None
VEX3902	With plug	None



⚠ Caution

How to Use DIN Terminal

Refer to page 1435 for VT307 series.

VEX3 Series Manifold Specifications

Manifold: VVEX Series

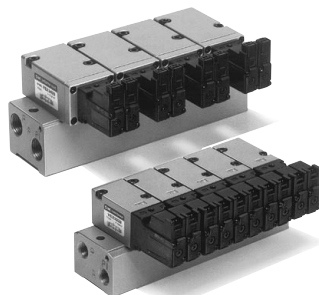

Specifications

Model	VVEX2		VVEX4		
Applicable valve	VEX3220/VEX3222		VEX3420/VEX3422		
Valve stations (Note)	2 to 8		2 to 6		
Port specifications	Common SUP, EXH				
Pilot type	Internal pilot, Common external pilot				
Common external pilot port size	M5 x 0.8 Length of thread 5				
Port size	1 (P)	1/4	3/8	3/8	1/2
	3 (R)		1/4	3/8	3/8
	2 (A)			3/8	3/8
Applicable blanking plate	VEX1-17 (With gasket, screw)		VEX4-5 (With gasket, screw)		

Note) When VVEX2 series is used with more than 5 stations, or VVEX4 series is used with more than 4 stations, apply pressure to the port 1 (P) on both sides and exhaust from the port 3 (R) on both sides.

Common External Pilot Piping

VVEX2-2

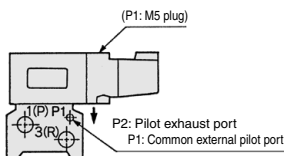

VVEX4-2

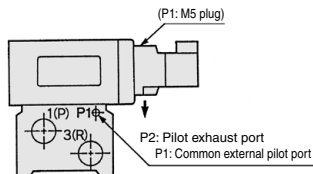

How to Order Manifold Base

VVEX 2 - 1 - 6 - 02

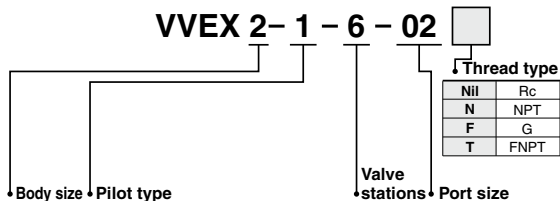

Note) Air operated

VEX 3220 and VEX3420 (air operated) are used. Distinction between the pilots (internal or external pilot) of the manifold base does not matter. Either may be used.

Example for ordering a manifold base:

The valve and blank plate for manifold arrangement should be specified in order from the left side of the manifold base (with the port 2 (A) on your side).

(Example)
 VVEX2-2-7-02N
 *VEX3222-1LN 6 pcs. } Solenoid
 *VEX1-17 1 pc.
 VVEX4-2-6-A
 *VEX3420 5 pcs. } Air operated
 *VEX4-5 1 pc.

Body size	Pilot type	Applicable valve	Valve stations	Port size			
				Port	1 (P)	3 (R)	2 (A)
2	1	Internal pilot VEX3222 (Air operated: VEX3220 (Note))	2	2	02	1/4	
			6	6			
	8	8					
4	1	Internal pilot VEX3422 (Air operated: VEX3420 (Note))	2	2	A	3/8	1/4
			6	6	B	3/8	
	2	2	Common external pilot VEX3222/VEX3421/VEX3422	6	6	C	1/2

VEX3 manifold (Size 2, 4) Pilot type

Manifold pilot type	Manifold part no.	Applicable valve part no.	Operating pressure range	Pilot pressure range
Air operated type	VVEX□-□-□-□	VEX3220/VEX3420	Low vacuum to 1.0 MPa	0.2 to 1.0 MPa
Internal pilot type	VVEX□-1-□-□	VEX3222/VEX3422	0.2 to 0.7 MPa	—
Common external pilot type	VVEX□-2-□-□	VEX3222/VEX3421/VEX3422	Low vacuum to 1.0 MPa	0.2 to 0.7 MPa
Individual external pilot type	VVEX□-□-□-□	VEX3221		

Note) If external pilot types are used, the common external pilot type is recommended.

VEX3 Series

Manifold: VVEX2-□

VVEX2- $\frac{1}{2}$ Applicable valve: VEX3220/3222

Valve mounting side

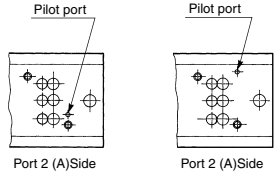
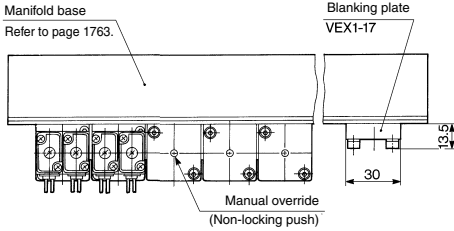

Internal pilot type Common external pilot

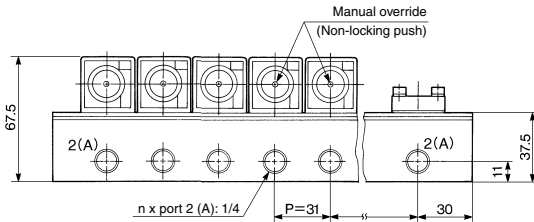
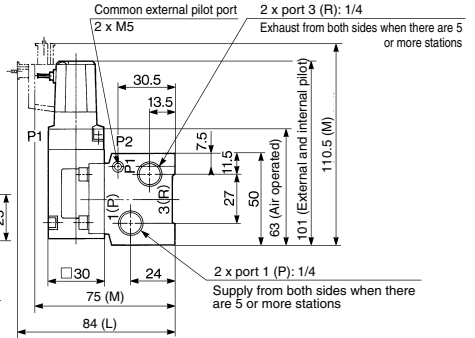
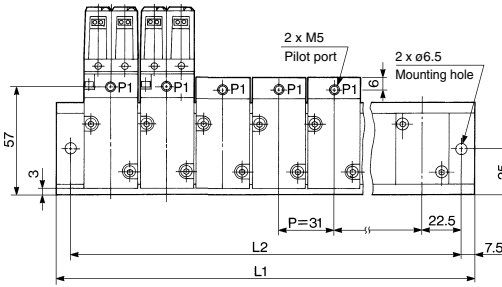

L Dimension Formula $L_1 = 31n + 29$, $L_2 = 31n + 14$ n: Station

n	2	3	4	5	6	7	8
L1	91	122	153	184	215	246	277
L2	76	107	138	169	200	231	262

Manifold: VVEX4-□

VVEX4-1 Applicable valve: VEX3420/3422
 VVEX4-2 Applicable valve: VEX3420/3422

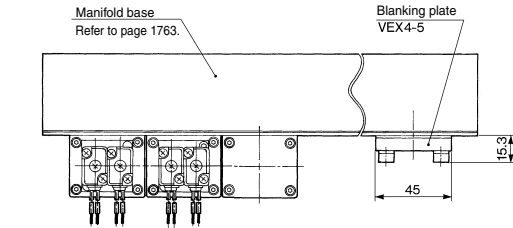

Valve mounting side

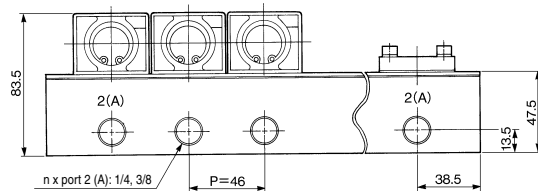
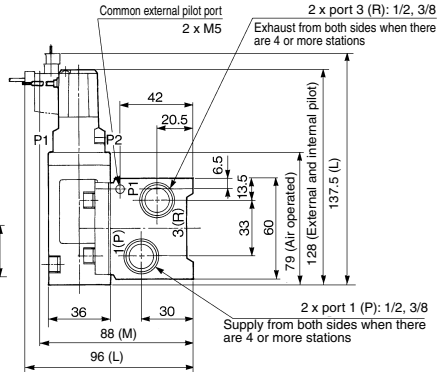
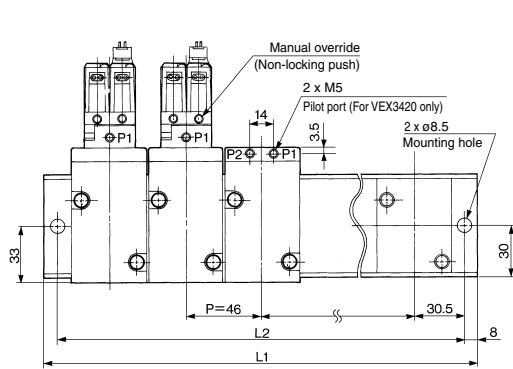
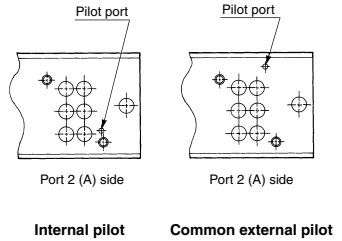

L Dimension $L_1 = 46n + 31$, $L_2 = 46n + 15$ n: Station

n	2	3	4	5	6
L1	123	169	215	261	307
L2	107	153	199	245	291

VEX

VEX3 Series

Construction/Working Principle/Component Parts

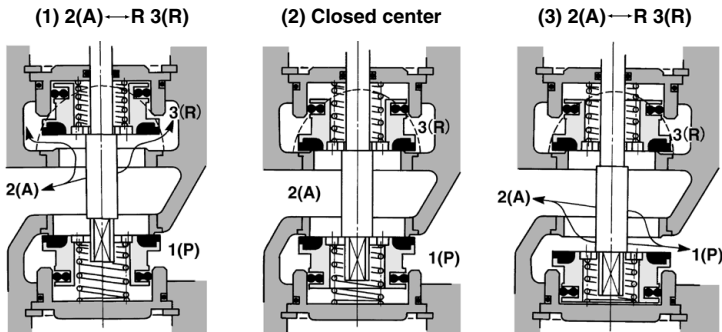

- This is a 3 port switch valve in which the shaft (7) - extending from the driving piston (3) opens/closes a pair of poppet valves (6). The poppet valve has a pressure balancing mechanism in which port 2 (A) pressure is constantly applied from the back and the center spring (4) is acting as a backup.
- When neither the pilot solenoid valve "a" nor "b" are energized (or when air is exhausted both from the port 12 (P1) and 23 (P2) of the air operated type), no force will act on the working piston, and the spring closes the poppet valve, thus the valve assumes the closed center position (DRW (2)).
- When the pilot solenoid valve "a" is energized (or when pressurized air enters through the port 12 (P1) of the air operated type), pilot air that enters the space above the working piston pushes down the piston and opens the lower poppet valve, thus connecting the port 1 (P) and port 2 (A) (DRW (3)). The upper poppet valve continues to close the port 3 (R) by means of pressure balance and the spring.
- When the pilot solenoid valve "b" is energized (or when pressurized air enters through the port 23 (P2) of the air operated type), the pilot air that enters the space under the working piston pushes the piston upward and opens the upper poppet valve, thus connecting the port 2 (A) and port 3 (R) (DRW (1)). The lower poppet valve continues to close the port 1 (P) by means of pressure balance and the spring.

VEX3120 (Air operated)

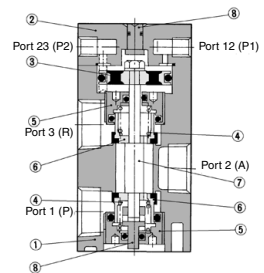

VEX3220 (Air operated)

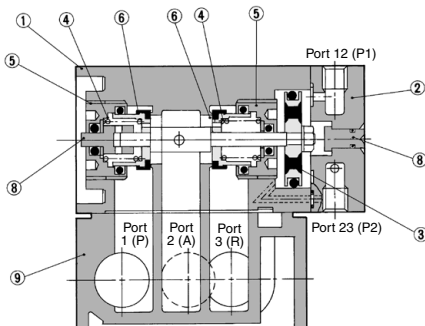

Component Parts

No.	Description	Material
1	Body	Aluminum alloy
2	Cover	Aluminum alloy
3	Working piston	Aluminum alloy
4	Center spring	Stainless steel
5	Valve guide	Aluminum alloy
6	Poppet valve	Aluminum alloy, Rubber
7	Shaft	Stainless steel
8	Manual override	POM
9	Sub-plate	Aluminum alloy

Construction/Working Principle/Component Parts

VEX3320 (Air operated)

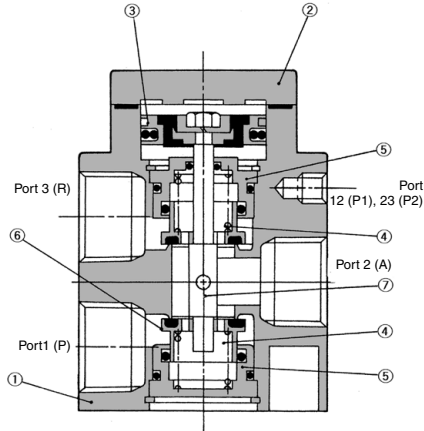

VEX3420 (Air operated)

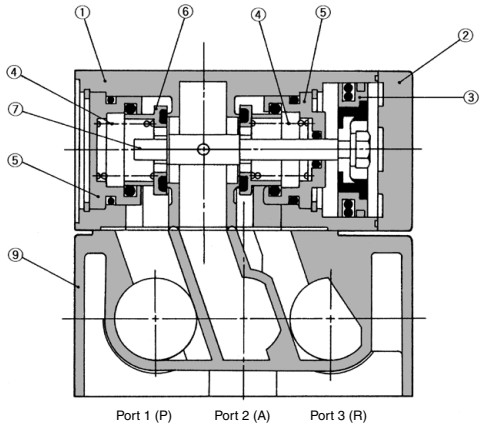

VEX350□/370□/390□ (Solenoid)

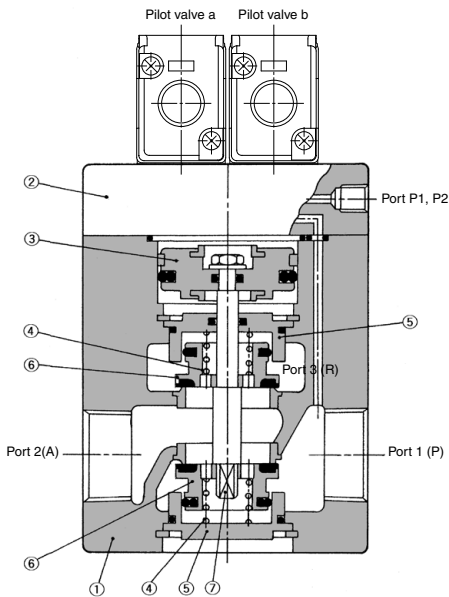

VEX



VEX3 Series Specific Product Precautions

Be sure to read this before handling the products.
Refer to back page 50 for Safety Instructions.

Connectors for the VEX3 Series Body Sizes 12, 22, 32 and 42 (For connectors for body sizes 50, 70, and 90, refer to VT307 series.)

Plug Connector Lead Wire Length

⚠ Caution

The standard length of a plug connector with lead wire is 300 mm, but the following lengths are also available.

How to Order Connector Assembly

DXT170-80-□ A-□

Lead wire colors

Symbol	Lead wire with socket	Note
Nil	Socket only (2 pcs.)	Without lead wire
1	Blue (2 pcs.)	For 100 VAC
2	Red (2 pcs.)	For 200 VAC
3	Gray (2 pcs.)	For other VAC
4	Red: +, Black: -	For DC

Lead wire length

Symbol	Lead wire length (L mm)
Nil	300
6	600
10	1000
15	1500
20	2000
25	2500
30	3000

How to Order

Specify the connector assembly part number together with the part number for the plug connector's solenoid valve without connector. (Note) The solenoid valve and the connector assembly are shipped separately.

Connector Assembly with Cover

⚠ Caution

- Connector assembly with protective cover enhances dust protection.
- Effective to prevent short circuit accidents due to penetration of foreign matter into the connector part.
- Cover material adopts the chloroprene rubber which is excellent in weather ability and electric insulation properties. However, use caution not to splash cutting oil, etc. onto it.
- Simple and unencumbered appearance by adopting a round-shaped cord.

How to Order

DXT170-123-A-□

Lead wire length

Symbol	Lead wire length (L mm)
Nil	300
6	600
10	1000
15	1500
20	2000
25	2500
30	3000

Connector assembly with cover: Dimensions

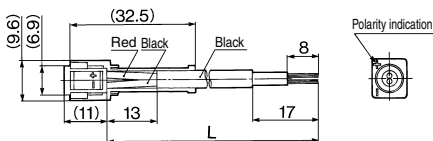

How to Use DIN Connector

⚠ Caution

Wiring

- Loosen the set screws and pull out connector from the terminal block of solenoid valve.
- Pull out screws and insert a screwdriver to the slit area near the bottom of terminal block to separate the terminal block and housing.
- Loosen the terminal screws (slotted screws) on the terminal block, insert the core of the lead wire into the terminal in accordance with the wiring method, and secure with the terminal screws.
- Tighten the ground nut to secure the cord.

Change of electrical entry

After separating the terminal block and housing, the cord entry direction can be changed by attaching the housing in the desired direction (4 directions in 90° increments).

* When equipped with light, avoid damaging the light with lead wire.

Caution

Plug a connector in or out vertically, never at an angle.

Applicable cables

Cord O.D.: $\phi 3.5$ to $\phi 7$

(Reference) 0.5 mm² 2-core and 3-core wires equivalent to JIS C 3306.

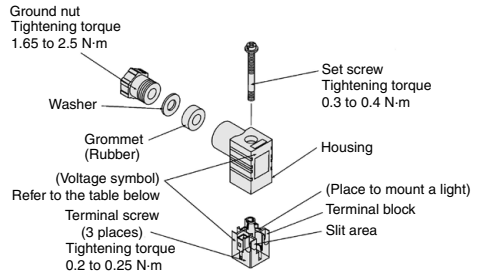

DIN connector part no.

Without light	DXT170-176-1
---------------	--------------

With Light

Rated voltage	Voltage symbol	Part no.
100 VAC	100 V	DXT170-176-2-01
200 VAC	200 V	DXT170-176-2-02
110 VAC	110 V	DXT170-176-2-03
220 VAC	220 V	DXT170-176-2-04
240 VAC	240 V	DXT170-176-2-07
6 VDC	6 VD	DXT170-176-3-51
12 VDC	12 VD	DXT170-176-3-06
24 VDC	24 VD	DXT170-176-3-05
48 VDC	48 VD	DXT170-176-3-53

Connector with light circuit

AC circuit

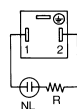

NL: Neon light
R: Resistor

DC circuit

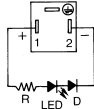

D: Protective diode
LED: LED diode
R: Resistor