

# Quick Exhaust Valve

# AQ Series

RoHS

Excellent exhaust characteristics

Large flow capacity

Compact and lightweight

A wide selection of models

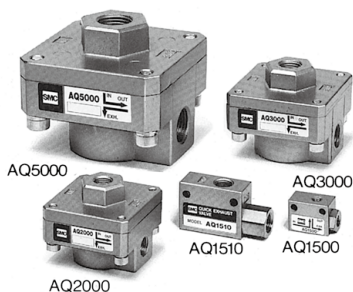

## Model

Model	Port size	Sonic conductance dm <sup>3</sup> /(s·bar)		Critical pressure ratio		Weight (g)
		IN → OUT	OUT → EXH	IN → OUT	OUT → EXH	
AQ1500-M5	M5 x 0.8	0.4	0.56	0.35	0.3	25
AQ1510-01	1/8	0.8	1.16			45
AQ2000-01	1/8	5	5	0.45	0.35	110
AQ2000-02	1/4	7	8			105
AQ3000-02	1/4	8	8.4			215
AQ3000-03	3/8	12	14			205
AQ5000-04	1/2	21	23			690
AQ5000-06	3/4	27	36			650

## Specifications

Fluid		Air
Proof pressure		1.5 MPa
Max. operating pressure	AQ15□0	0.7 MPa
	AQ2000 to 5000	1 MPa
Min. operating pressure	AQ15□0	0.1 MPa
	AQ2000 to 5000	0.05 MPa
Ambient and fluid temperature		-5 to 60°C (No freezing)

## Symbol

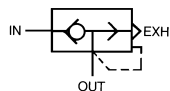

## How to Order

**AQ 2 0 0 0 - □ 02 - □**

**Standard size**

1	1/8
2	1/4
3	3/8
5	3/4

**Type**

Symbol	Type	Applicable model
0	Diaphragm	AQ2 to AQ5
5	Lip	AQ1 Only

**Standard**

0	M5 x 0.8
1	1/8

Note) \*AQ15□0" only

**Thread type**

Nil	Metric thread (M5)
N	Rc
N	NPT
F	G

**Option**

Nil	Standard (-5 to 60°C)
H	High temperature (-5 to 80°C)
L	Low temperature (-30 to 60°C)

Note) AQ1500 and AQ1510 are not available.

**Port size**

Port size	Applicable series
M5	M5 x 0.8
01	1/8
02	1/4
03	3/8
04	1/2
06	3/4

**Construction**

**AQ1500/1510**

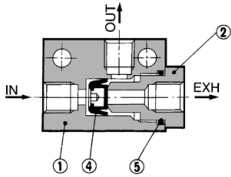

**AQ2000/3000/5000**

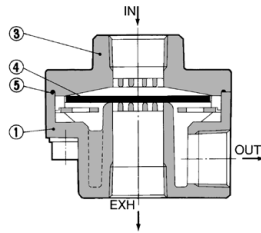

**Component Parts**

No.	Description	Material/Model		
		AQ1500	AQ1510	AQ2000, 3000, 5000
1	Body	Zinc die-casted	Zinc die-casted	Aluminum die-casted
2	Guide	Brass	Brass	—
3	Cover	—	—	Aluminum die-casted

**Replacement Parts**

No.	Description	Material	Part no.				
			AQ1500	AQ1510	AQ2000	AQ3000	AQ5000
4	Valve	NBR	30083	30093	30073	30053	30063
5	O-ring	NBR	KA00327 9 x 7 x 1	KA00476 JISB2401P-7	CA40-1601	CA50-1602	30066

**Dimensions**

**AQ1500/1510**

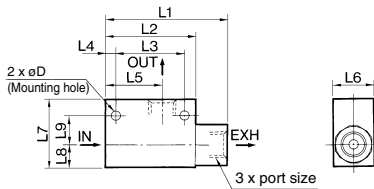

Model	Port size	L1	L2	L3	L4	L5	L6	L7	L8	L9	D
AQ1500	M5 x 0.8	23	20	14	3	12.5	12	15	5.5	6.5	3.1
AQ1510	1/8	45	33	25	4	21	15	25	8	11	4.3

**AQ2000/3000/5000**

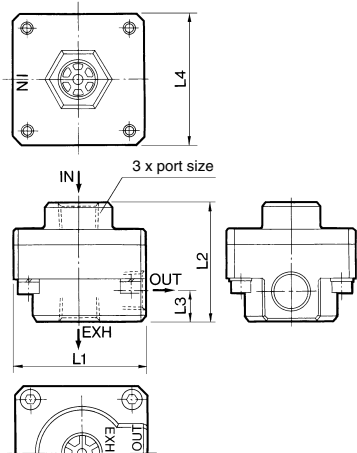

Model	Port size	L1	L2	L3	L4
AQ2000	1/8, 1/4	45	40	10	45
AQ3000	1/4, 3/8	56	50	12.5	56
AQ5000	1/2, 3/4	85	75	18	85

**⚠ Specific Product Precautions**

Be sure to read this before handling the products. Refer to back page 50 for Safety Instructions and pages 543 to 546 for Flow Control Equipment Precautions.

**Design/Selection**

**⚠ Caution**

- In the following cases, insufficient exhaust or vibration may cause noise.
  - With residual pressure or back pressure on the IN side.
  - When the differential pressure between the IN and OUT sides is smaller than the minimum operating pressure.
  - When the effective area of the IN side piping of AQ, or the solenoid valve, is smaller than AQ.

- AS-F
- TMH
- ASD
- AS
- AS-FE
- KE
- AS-FG
- AS-FP
- AS-FM
- AS-D
- AS-T
- ASP
- ASN
- AQ**
- ASV
- AK
- VCHC
- ASR
- ASQ

# Quick Exhaust Valve with One-touch Fittings

RoHS

# AQ240F/340F Series



With exhaust port fitting

With silencer

### Symbol

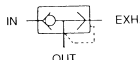

With exhaust port fitting

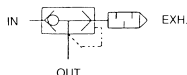

With silencer

### How to Order

**AQ 2 4 0 F - 06 - 06**

Quick exhaust valve

Body size

2	M5
3	1/8"

In-line type

Exhaust port

00	With silencer
04	Applicable tubing O.D. $\phi 4$
06	Applicable tubing O.D. $\phi 6$
07	Applicable tubing O.D. $\phi 1/4"$

IN, OUT port applicable tubing O.D.

04	$\phi 4$
06	$\phi 6$
07	$\phi 1/4"$

With One-touch fittings

Note) Brass parts are all electroless nickel plated.

### Specific Product Precautions

Be sure to read this before handling the products.  
Refer to back page 50 for Safety Instructions and pages 543 to 546 for Flow Control Equipment Precautions.

### Design/Selection

### Caution

1. In the following cases, insufficient exhaust or vibration may cause noise.

- With residual pressure or back pressure on the IN side.
- When the differential pressure between the IN and OUT sides is smaller than the minimum operating pressure.
- When the effective area of the IN side piping of AQ, or the solenoid valve, is smaller than AQ.

### Space-saving

Rectilinear IN-OUT tubing connections

- With One-touch fittings and silencer
- With silencer
- Lightweight (Resin body)

### Specifications

Fluid	Air
Proof pressure	1.5 MPa
Max. operating pressure	1 MPa
Min. operating pressure	0.1 MPa
Ambient and fluid temperature	-5 to 60°C (No freezing)
Applicable tubing material <sup>(1)</sup>	Nylon, Soft nylon, Polyurethane

Note 1) Use caution regarding the max. operating pressure when soft nylon or polyurethane tubing is used. (Refer to pages 464 and 465 for details.)

### Model

Model	Applicable tubing O.D.			Sonic conductance dm <sup>2</sup> /(s·bar)		Critical pressure ratio	
	4	6	1/4"	IN → OUT	OUT → EXH.	IN → OUT	OUT → EXH.
AQ240F-04-□	●			0.34	0.5	0.15	0.15
AQ240F-06-□		●		0.48	0.54		
AQ340F-06-□			●	0.8	0.8		
AQ240F-07-□			●	0.48	0.54		
AQ340F-07-□			●	0.8	0.8		

### Circuit

With silencer

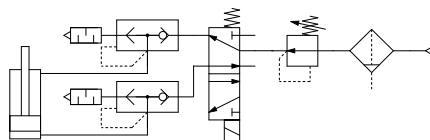

With exhaust port fitting

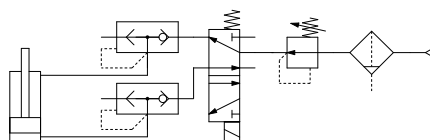

## Construction

### With silencer

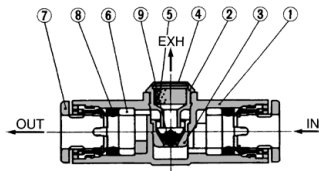

No.	Description	Material	Note
1	Body A	PBT	
2	Seat ring	Brass	Electroless nickel plated
3	Valve seat	Brass	Electroless nickel plated
4	Silencer cover	Stainless steel 304	
5	Silencer	PVA sponge	
6	Spacer	POM	
7	Cassette	—	
8	Seal	NBR	
9	Valve	HNBR	

### With exhaust port fitting

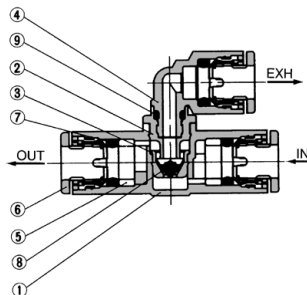

No.	Description	Material	Note
1	Body A	PBT	
2	Seat ring	Brass	Electroless nickel plated
3	Valve seat	Brass	Electroless nickel plated
4	Elbow union body	PBT	
5	Spacer	POM	
6	Cassette	—	
7	Seal	NBR	
8	Valve	HNBR	
9	O-ring	NBR	

## Dimensions

### With silencer

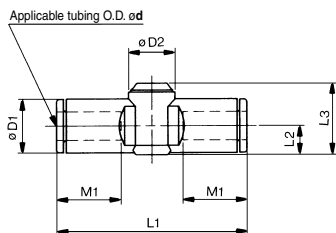

Model	Tubing O.D. $\phi$ d	D1	D2	L1	L2	L3	M1	Weight (g)
AQ240F-04-00	4	9.3	10.0	39.2	5.2	14.3	12.9	5
AQ240F-06-00	6	11.6	10.0	40.7	6.2	15.4	13.7	6
AQ340F-06-00	6	11.6	11.8	44.8	6.3	19.5	13.7	11
AQ240F-07-00	1/4"	12	10.0	40.7	6.2	15.4	13.7	6
AQ340F-07-00	1/4"	13.2	11.8	52.2	7.1	20.3	16.8	11

### With exhaust port fitting

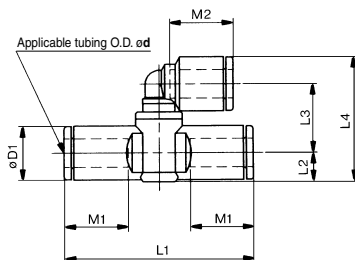

Model	Tubing O.D. $\phi$ d	D1	L1	L2	L3	L4	M1	M2	Weight (g)
AQ240F-04-04	4	9.3	39.2	5.2	13.7	23.5	12.9	12.9	6
AQ240F-06-06	6	11.6	40.7	6.2	14.7	26.7	13.7	13.7	8
AQ340F-06-06	6	11.6	44.8	6.3	19.6	31.7	13.7	13.7	13
AQ240F-07-07	1/4"	12	40.7	6.2	15.1	27.3	13.7	13.7	8
AQ340F-07-07	1/4"	13.2	52.2	7.1	20.0	33.1	16.8	13.7	13

AS-F  
TMH  
ASD  
AS  
AS-FE  
KE  
AS-FG  
AS-FP  
AS-FM  
AS-D  
AS-T  
ASP  
ASN  
AQ  
ASV  
AK  
VCHC  
ASR  
ASQ