

2-Color Display Digital Pressure Switch

ISE70/75/75H Series

- NPN/PNP open collector 2 outputs added.
- Zero-cut off display function added.

The ISE70/75 series has been remodeled.
Click [here](#) for details.



Rated Pressure

Metal Body Type
(Die-cast aluminum)

For
General
Fluids

10 MPa (ISE75) • **15 MPa** (ISE75H)

For Air

1 MPa (ISE70)

2-color
digital

IP67



- ZSE20
- ISE20
- ZSE30
- ISE30
- ZSE40
- ISE40
- ZSE10
- ISE10
- ISE70**
- ZSE80
- ISE80
- PS
- ISA3
- ISA2
- ISE35
- PSE
- IS
- ISG
- ZSM1

2-Color Display (Green/Red)

- Selectable from four patterns

	ON	OFF
①	Red	Green
②	Green	Red
③	Red	Red
④	Green	Green

See abnormal values at a glance.



M12 Connector

- Lead wire with M12 connector (5 m)
- Straight and right-angled connectors

With Bracket

- User-selectable mounting orientation

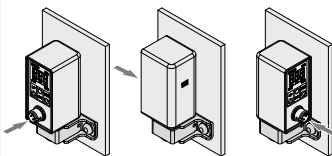

- Withstand pressure: 3 times the rated pressure
- Model with initial display settings of psi is also available as standard.
- Port size
Rc1/4, NPT1/4, G1/4 (ISO1179)

Functions

- Anti-chattering
- Display calibration
- Zero-clear
- Keylock
- Display unit switching
(Fixed SI unit in Japan)

For Air	For General Fluids	
ISE70 (1 MPa)	ISE75 (10 MPa)	ISE75H (15 MPa)
Plain	Gray	Orange

2-Color Display Digital Pressure Switch

For Air

ISE70 Series



RoHS

The ISE70 series has been remodeled.
Click [here](#) for details.

How to Order

1 MPa

ISE70 - 02 - 43 - M

Piping specifications

02	Rc1/4
N02	NPT1/4
F02	G1/4 (ISO 1179)

Output specifications

27	2 settings NPN open collector 2 outputs (Pin no.: 2, 4)
43	Fixed setting: NPN open collector 1 output (Pin no.: 4) + PNP open collector 1 output (Pin no.: 2)
65	PNP open collector 1 output (Pin no.: 4)
67	2 settings PNP open collector 2 outputs (Pin no.: 2, 4)

Unit specifications

Nil	With display unit switching function ^{Note 1)}
M	Fixed SI unit ^{Note 2)}
P	Pressure unit: psi (Initial value) With display unit switching function ^{Note 1)}

Note 1) Under the New Measurement Law, sales of switches with the unit switching function are not allowed for use in Japan.

Note 2) Fixed unit: MPa

Option 2

Nil	None
A	With bracket  <small>Note) Mounting screws are not included.</small>

Option 1

Nil	None
S	Lead wire with M12 connector (5 m), straight
L	Lead wire with M12 connector (5 m), right-angled



Option/Part No.

When optional parts are required separately, use the following part numbers to place an order.

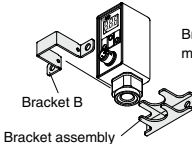
Option	Part no.	Note
Bracket	ZS-31-A	 <p>Bracket B and the bracket assembly make up one set. <small>Note) Mounting screws are not included.</small></p>
Lead wire with M12 connector, straight	ZS-31-B	Lead wire length: 5 m
Lead wire with M12 connector, right-angled	ZS-31-C	Lead wire length: 5 m

Refer to pages 11 and 12 for Pressure Switch Precautions. For details about the Specific Product Precautions, refer to the Operation Manual on the SMC website, <http://www.smcworld.com> Click [here](#) for details.

Specifications

Model		ISE70
Rated pressure range		0 to 1 MPa
Pressure display range/Set pressure range		-0.1 to 1 MPa
Withstand pressure		1.5 MPa
Pressure display resolution/Set pressure resolution		0.01 MPa
Applicable fluid		Air, Non-corrosive gas, Non-flammable gas
Power supply voltage		12 to 24 VDC±10%, Ripple (p-p) 10% or less (with power supply polarity protection)
Current consumption		55 mA or less (at no load)
Switch output		Output -27: 2 settings; NPN open collector 2 outputs (Pin no.: 2, 4) Output -43: Fixed setting; NPN open collector 1 output (Pin no.: 4) + PNP open collector 1 output (Pin no.: 2) ^{Note 1)} Output -65: PNP open collector 1 output (Pin no.: 4) Output -67: 2 settings; PNP open collector 2 outputs (Pin no.: 2, 4)
	Max. load current	80 mA
	Max. applied voltage	30 V (at NPN output)
	Residual voltage	1 V or less (with load current of 80 mA)
	Response time	2.5 ms (with anti-chattering function: 20 ms, 160 ms, 640 ms, 1000 ms, 2000 ms)
	Short circuit protection	With short circuit protection
Repeatability		±0.5%F.S.
Hysteresis	Hysteresis mode	Variable (0 or above)
	Window comparator mode	
Display		3-digit, 7-segment indicator, 2-color display (Red/Green) can be interlocked with the switch output. Sampling cycle: 5 times/1 s
Display accuracy		2%F.S.±1 digit (at 25°C±3°C)
Indicator light		OUT1: Light up when output is turned ON. (Green) OUT2: Light up when output is turned ON. (Red: for output -27, -67)
Functions		Anti-chattering function, Display unit switching function, Zero-clear function, Keylock function
Environment	Enclosure	IP67 ^{Note 2)}
	Fluid temperature range	0 to 50°C (No freezing or condensation)
	Operating temperature range	Operating: 0 to 50°C, Stored: -10 to 60°C (No freezing or condensation)
	Operating humidity range	Operating and stored: 35 to 85%RH (No condensation)
	Withstand voltage	1000 VAC for 1 minute between terminals and housing
	Insulation resistance	50 MΩ or more (500 VDC measured via megohmmeter) between terminals and housing
Temperature characteristics (25°C reference: within operating temperature range)		±2%F.S.
Standards		CE, UL/CSA (E216656) RoHS
Wetted parts material		Fitting: C3604 (electroless nickel plating) Sensor pressure receiving area: Silicon, O-ring: NBR
Port size		02: Rc1/4, N02: NPT1/4, F02: G1/4 (ISO 1179) ^{Note 3)}
Lead wire with connector		Oilproof cable with M12 4-pin pre-wired connector, 4 cores, ø4, 5 m, Conductor O.D.: 0.72 mm, Insulator O.D.: 1.14 mm
Weight		190 g (excluding the lead wire with M12 4-pin pre-wired connector)

Note 1) The NPN and PNP outputs function for a single set point.

Note 2) An FKM gasket is used for the product case seat. Refer to the Operation Manual at SMC's website for details.

Note 3) G1/4: Applicable to ISO 1179-1

ZSE20
ISE20

ZSE30
ISE30

ZSE40
ISE40

ZSE10
ISE10

ISE70

ZSE80
ISE80

PS

ISA3

ISA2

ISE35

PSE

IS

ISG

ZSM1

2-Color Display Digital Pressure Switch

For General Fluids



RoHS

ISE75/75H Series

The ISE75 (For 10 MPa) series has been remodeled. Click [here](#) for details.

How to Order

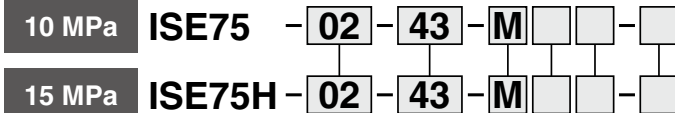

Piping specifications

02	Rc1/4
N02	NPT1/4
F02	G1/4 (ISO 1179)

Output specifications

27	2 settings NPN open collector 2 outputs (Pin no.: 2, 4)
43	Fixed setting: NPN open collector 1 output (Pin no.: 4) + PNP open collector 1 output (Pin no.: 2)
65	PNP open collector 1 output (Pin no.: 4)
67	2 settings PNP open collector 2 outputs (Pin no.: 2, 4)

Unit specifications

Nil	With display unit switching function <small>Note 1)</small>
M	Fixed SI unit <small>Note 2)</small>
P	Pressure unit: psi (Initial value) With display unit switching function <small>Note 1)</small>

Note 1) Under the New Measurement Law, sales of switches with the unit switching function are not allowed for use in Japan.

Note 2) Fixed unit: MPa

Made to Order

Symbol	Specifications
X500	Analog voltage output

Refer to page 87 for details.

Option 2

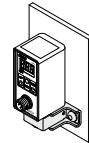
Nil	None
A	With bracket 

Note) Mounting screws are not included.

Option 1

Nil	None
S	Lead wire with M12 connector (5 m), straight
L	Lead wire with M12 connector (5 m), right-angled

Option/Part No.

When optional parts are required separately, use the following part numbers to place an order.

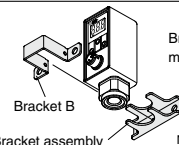
Option	Part no.	Note
Bracket	ZS-31-A	 <p>Bracket B and the bracket assembly make up one set.</p> <p>Note) Mounting screws are not included.</p>
Lead wire with M12 connector, straight	ZS-31-B	Lead wire length: 5 m
Lead wire with M12 connector, right-angled	ZS-31-C	Lead wire length: 5 m

2-Color Display Digital Pressure Switch *ISE75/75H Series*

Refer to pages 11 and 12 for Pressure Switch Precautions. For details about the Specific Product Precautions, refer to the Operation Manual on the SMC website, <http://www.smcworld.com> Click [here](#) for details.

Specifications

Model		ISE75	ISE75H
Rated pressure range		0 to 10 MPa	0 to 15 MPa
Pressure display range/Set pressure range[*]		0.4 to 10 MPa	0.5 to 15 MPa
Withstand pressure		30 MPa	45 MPa
Pressure display resolution/Set pressure resolution		0.1 MPa	
Applicable fluid		Fluid or gas that will not corrode stainless steel 304, 430 and 630	
Power supply voltage		12 to 24 VDC±10%, Ripple (p-p) 10% or less (with power supply polarity protection)	
Current consumption		55 mA or less (at no load)	
Switch output		Output -27: 2 settings; NPN open collector 2 outputs (Pin no.: 2, 4) Output -43: Fixed setting; NPN open collector 1 output (Pin no.: 4) + PNP open collector 1 output (Pin no.: 2) ^{Note 1)} Output -65: PNP open collector 1 output (Pin no.: 4) Output -67: 2 settings; PNP open collector 2 outputs (Pin no.: 2, 4)	
	Max. load current	80 mA	
	Max. applied voltage	30 V (at NPN output)	
	Residual voltage	1 V or less (with load current of 80 mA)	
	Response time	2.5 ms (with anti-chattering function: 20 ms, 160 ms, 640 ms, 1000 ms, 2000 ms)	
	Short circuit protection	With short circuit protection	
Repeatability		±0.5%F.S.	
Hysteresis	Hysteresis mode	Variable (0 or above)	
	Window comparator mode		
Display		3-digit, 7-segment indicator, 2-color display (Red/Green) can be interlocked with the switch output. Sampling cycle: 5 times/1 s	
Display accuracy		2%F.S.±1 digit (at 25°C±3°C)	
Indicator light		OUT1: Lights up when output is turned ON. (Green) OUT2: Lights up when output is turned ON. (Red: for output -27, -67)	
Functions		Anti-chattering function, Display unit switching function, Zero-clear function, Keylock function	
Environment	Enclosure	IP67 ^{Note 2)}	
	Fluid temperature range	-5 to 80°C (No freezing or condensation)	
	Operating temperature range	Operating: -5 to 50°C, Stored: -10 to 60°C (No freezing or condensation)	
	Operating humidity range	Operating and stored: 35 to 85%RH (No condensation)	
	Withstand voltage	250 VAC for 1 minute between terminals and housing	
	Insulation resistance	50 MΩ or more (50 VDC measured via megohmmeter) between terminals and housing	
Temperature characteristics (25°C reference: within operating temperature range)		±3%F.S.	
Standards		CE , UL/CSA (E216656) RoHS	
Wetted parts material	Pressure sensor	Stainless steel 630	
	Fitting	Stainless steel 304	Stainless steel 304 (port size Rc1/4) Stainless steel 430 (port size NPT1/4, G1/4)
Port size		02: Rc1/4, N02: NPT1/4, F02: G1/4 (ISO 1179) ^{Note 3)}	
Lead wire with connector		Oilproof cable with M12 4-pin pre-wired connector, 4 cores, ø4, 5 m, Conductor O.D.: 0.72 mm, Insulator O.D.: 1.14 mm	
Weight		225 g	225 g (port size Rc1/4) 210 g (port size NPT1/4, G1/4)
		145 g (Lead wire with M12 4-pin pre-wired connector)	

Note 1) The NPN and PNP outputs function for a single set point.

Note 2) An FKM gasket is used for the product case seal. Refer to the Operation Manual at SMC's website for details.

Note 3) G1/4: Applicable to ISO 1179-1

* Refer to page 84 for the pressure display range.

ZSE20
ISE20

ZSE30
ISE30

ZSE40
ISE40

ZSE10
ISE10

ISE70

ZSE80
ISE80

PS

ISA3

ISA2

ISE35

PSE

IS

ISG

ZSM1

ISE70/75/75H Series

Set Pressure Range and Rated Pressure Range

Set the pressure to within the rated pressure range.



The set pressure range is the range of pressure that is possible in setting.

The rated pressure range is the range of pressure that satisfies the specifications (accuracy, linearity, etc.) on the switch.

Although it is possible to set a value outside the rated pressure range, the specifications will not be guaranteed even if the value stays within the set pressure range.

Switch		Pressure range						
		-100 kPa	0	0.4 MPa	0.5 MPa	1 MPa	10 MPa	15 MPa
For 1 MPa (For Air)	ISE70		0	1 MPa				
		-100 kPa (-0.1 MPa)		1 MPa				
For 10 MPa (For General Fluids)	ISE75		0	10 MPa				
			0.4 MPa	10 MPa				
For 15 MPa (For General Fluids)	ISE75H		0	15 MPa				
				0.5 MPa	15 MPa			

* The ISE75(H) switch shows zero (0) when the pressure being applied goes below the lower limit of the set pressure range, when the zero-cut off display function is selected.

 Rated pressure range of switch
 Set pressure range of switch

Internal Circuits and Wiring Examples

-27 NPN (2 outputs)

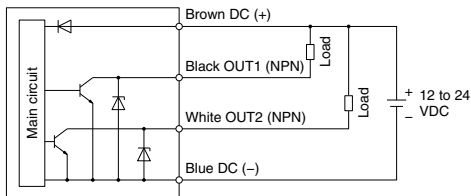

-43 NPN (1 output) + PNP (1 output)

(The pressure set point for switching the output signal is common to NPN and PNP.)

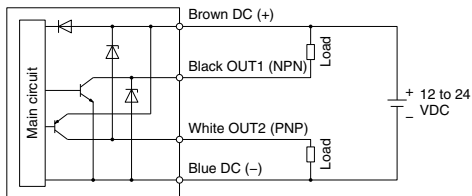

-65 PNP (1 output)

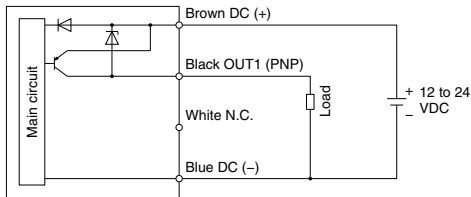

-67 PNP (2 outputs)

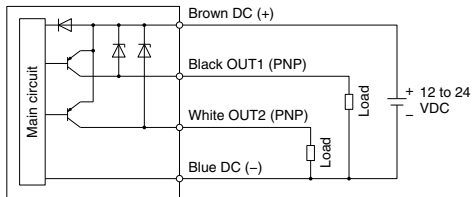

2-Color Display Digital Pressure Switch *ISE70/75/75H Series*

Dimensions

ISE70/75/75H

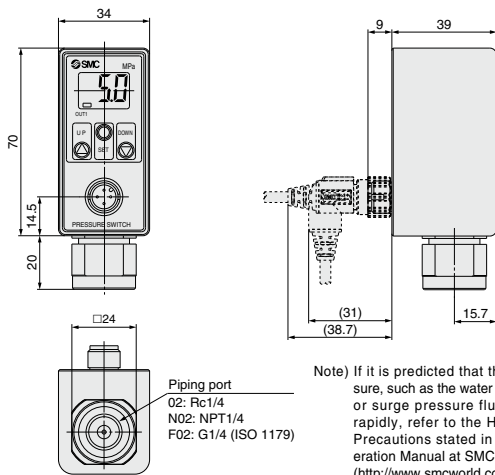

Note) If it is predicted that the pressure, such as the water hammer or surge pressure fluctuates rapidly, refer to the Handling Precautions stated in the Operation Manual at SMC website (<http://www.smcworld.com>).

Note) The connector faces down (toward the piping). Do not attempt to rotate the connector, as it is not rotatable.

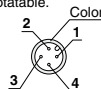

Bracket mount

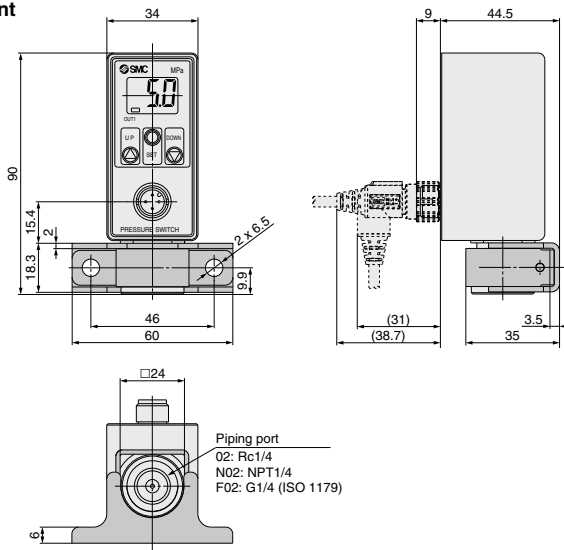

Connector pin number

Output -43
(Color: Gray)

1	Brown	DC (+)
2	White	OUT1 (PNP)
3	Blue	DC (-)
4	Black	OUT1 (NPN)

Output -65
(Color: Black)

1	Brown	DC (+)
2	White	NC
3	Blue	DC (-)
4	Black	OUT1 (PNP)

Output -27 and -67
(Color: Gray)

1	Brown	DC (+)
2	White	OUT2 (NPN or PNP)
3	Blue	DC (-)
4	Black	OUT1 (NPN or PNP)

Lead wire with connector ZS-31-B

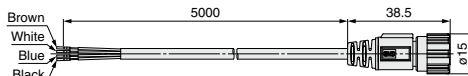

Lead wire with connector ZS-31-C

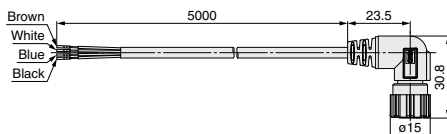

ISE70/75/75H Series

Functions

A Display calibration function

Fine adjustment of the indicated value of the pressure sensor can be made within the range of $\pm 5\%$ of the read value. (The scattering of the indicated value can be eliminated.)

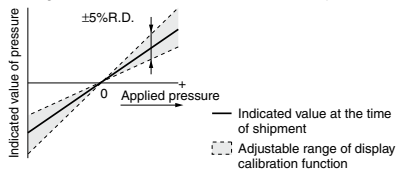

Note) When the display calibration function is used, the set pressure value may change ± 1 digit.

B Peak/Bottom hold function

This function constantly detects and updates the maximum and minimum pressure values and allows the unit to hold the display value.

C Keylock function

Prevents operation errors such as accidentally changing setting values.

D Zero-clear function

The measured pressure reading can be adjusted to zero. More specifically, the factory-set reading can be corrected to within $\pm 7\%$ F.S.

E Display unit switching function

Display units can be switched with this function.

Unit/Reading resolution	ISE70	ISE75/75H
MPa	0.01	0.1
kgf/cm ²	0.1	1
bar	0.1	1
psi	1	1 (X10)

F Anti-chattering function

A large bore cylinder or ejector consumes a large amount of air in operation and may experience a temporary drop in the primary pressure. This function prevents detection of such temporary drops in primary pressure as abnormal pressure.

Response time selections: 20 ms, 160 ms, 640 ms, 1000 ms, 2000 ms

H Zero-cut off display function

With the ISE75 series, users can enable or disable a function (zero-cut off display function) that displays pressure values of 0.3 MPa or less as zero (0.4 MPa or less in the ISE75H series).

Example pressure displays (shading indicates changed displays)

ISE75-□ (for 10 MPa)

Zero-cut off display function "ON": 0 → **Displayed as 0** → 0.4 → 0.5 → 0.6 → → 9.9 → 10.0

Zero-cut off display function "OFF": 0 → 0.1 → 0.2 → 0.3 → 0.4 → 0.5 → 0.6 → → 9.9 → 10.0

ISE75H-□ (for 15 MPa)

Zero-cut off display function "ON": 0 → **Displayed as 0** → 0.5 → 0.6 → → 14.9 → 15.0

Zero-cut off display function "OFF": 0 → 0.1 → 0.2 → 0.3 → 0.4 → 0.5 → 0.6 → → 14.9 → 15.0

Pressure Display Range

Series	Zero-cut off display function "ON"	Zero-cut off display function "OFF"
ISE75	0, 0.4 to 10.0 MPa	0 to 10.0 MPa
ISE75H	0, 0.5 to 15.0 MPa	0 to 15.0 MPa

* The set pressure range does not change when the zero-cut off display function is disabled.

G Error function

Take the following corrective actions when error occurs.

Error description	LCD display	Description	Action
Over-current error	OUT1	Load current of switch output exceeds 80 mA.	Eliminate the cause of the over current by turning off the power supply, and then turn on it again.
	Note 1) OUT2		
Residual pressure error	Er3	During zero-clear operation, pressure over $\pm 7\%$ F.S. is applied. After 3 second, the mode will reset to measurement mode. $\pm 1\%$ F.S. of the zero-clear range varies between individual products.	Perform zero-clear operation again after restoring the applied pressure to an atmospheric pressure condition.
Applied pressure error	HHH	Supply pressure exceeds the maximum set pressure.	Reset applied pressure to a level within the set pressure range.
	LLL	Supply pressure is below the minimum set pressure.	
System error	Er4	Internal data error	Turn the power off and turn it on again.
	Er6	Internal data error	
	Er7	Internal data error	
	Er8	Internal data error	

* If the failure cannot be solved after the above instructions are performed, please contact SMC for investigation.

Note 1) Output -27 and -67 only.

ISE75(H) Series

Made to Order Specifications

Please contact SMC for detailed dimensions, specifications and lead times.



1 Analog Voltage Output Specifications

Symbol
-X500

This product is compatible with NPN open collector 1 output + Analog voltage output.

How to Order

* Refer to "How to Order" on page 82 for the standard specifications.

ISE75(H) - [] - 43 - [] - X500

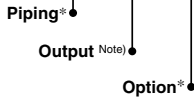

Note) The output is applicable to 43 only.

Specifications

Analog voltage output	Output voltage: 1 to 5 V \pm 2.5% F.S. (In rated pressure range) Output impedance: Approx. 1 k Ω Response time: 300 ms or less												
Connector pin number	 <table border="1" data-bbox="448 813 649 901"> <tr> <td>1</td> <td>Brown</td> <td>DC (+)</td> </tr> <tr> <td>2</td> <td>White</td> <td>Analogue output</td> </tr> <tr> <td>3</td> <td>Blue</td> <td>DC (-)</td> </tr> <tr> <td>4</td> <td>Black</td> <td>OUT1 (NPN)</td> </tr> </table>	1	Brown	DC (+)	2	White	Analogue output	3	Blue	DC (-)	4	Black	OUT1 (NPN)
1	Brown	DC (+)											
2	White	Analogue output											
3	Blue	DC (-)											
4	Black	OUT1 (NPN)											

Models other than above are the same specifications as standard.

- ZSE20
- ISE20
- ZSE30
- ISE30
- ZSE40
- ISE40
- ZSE10
- ISE10
- ISE70**
- ZSE80
- ISE80
- PS**
- ISA3**
- ISA2**
- ISE35**
- PSE**
- IS**
- ISG**
- ZSM1**