

4/5 Port Solenoid Valve

Series SYJ3000/5000/7000

Rubber Seal

CE
[Option]

Power Consumption
0.1W*
With Power Saving Circuit

* For details, refer to page 752.

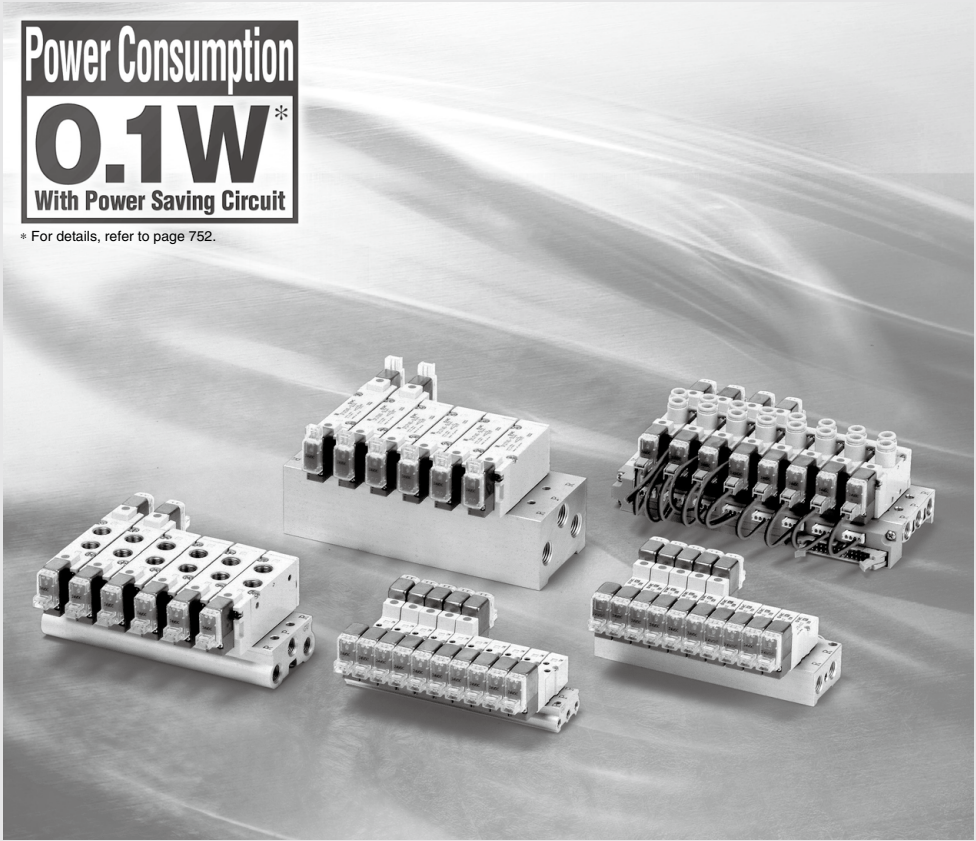

- SJ
- SY
- SY
- SV
- SYJ**
- SZ
- VF
- VP4
- S0700
- VQ
- VQ4
- VQ5
- VQC
- VQC4
- VQZ
- SQ
- VFS
- VFR
- VQ7

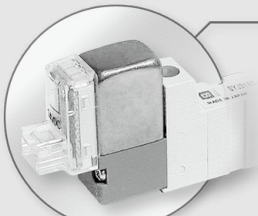

Cover (stainless steel)

● Improved pilot valve

Pilot valve cover is stronger using stainless steel.
Mounting thread is also reinforced from size M1.7 to M2.

● Flow Characteristics

Series	Flow characteristics		
	C [(dm ³ /s·bar)]	b	Cv
SYJ3000	0.46	0.36	0.12
SYJ5000	0.83	0.32	0.21
SYJ7000	2.9	0.35	0.74

Manifold Variations

Manifold Variations	A, B port size							Manifold option				
	M3	M5	1/8	One-touch fittings					Blanking plate	Individual SUP spacer	Individual EXH spacer	Interface regulator
				ø4	ø6	ø8	ø5/32"	ø1/4"				





Individual wiring

Common SUP/Common EXH style	5 port body ported	Type 20	SYJ3000 P. 676	●	—	—	—	—	—	—	—	●	—	—	—
				SYJ5000 P. 704	—	●	—	●	●	—	●	●	—	●	—
Common SUP/Common EXH style	5 port body ported	Type 21	SYJ7000 P. 736	—	—	●	—	●	●	—	●	●	—	●	—
				SYJ3000 P. 676	—	—	—	—	—	—	—	—	—	—	—
Common SUP/Common EXH style	4 port base mounted	Type 31	SYJ3000 P. 676	●	—	—	—	—	—	—	—	●	—	—	—
				SYJ3000 P. 676	—	●	—	●	—	—	●	—	—	—	—
Common SUP/Common EXH style	4 port base mounted	Type 32	SYJ3000 P. 676	—	●	—	●	—	—	●	—	—	—	—	—
				SYJ3000 P. 676	—	—	—	—	—	—	—	—	—	—	—
Common SUP/Common EXH style	5 port base mounted	Type 40	SYJ5000 P. 704	—	●	—	—	—	—	—	—	●	—	●	●
				SYJ7000 P. 736	—	—	●	—	—	—	—	—	—	●	●
Common SUP/Common EXH style	5 port base mounted	Type 41	SYJ3000 P. 676	—	●	—	●	—	—	●	—	—	—	—	—
				SYJ5000 P. 704	—	●	—	—	—	—	—	—	—	—	—
Common SUP/Common EXH style	5 port base mounted	Type 42	SYJ5000 P. 704	—	—	●	—	●	—	—	●	—	—	—	—
				SYJ7000 P. 736	—	—	—	●	●	—	●	●	—	●	●
Common SUP/Common EXH style	5 port base mounted	Type 43	SYJ5000 P. 704	—	—	—	●	—	—	●	—	—	—	—	—
				SYJ5000 P. 704	—	—	—	—	—	—	—	—	—	—	—
Common SUP/Individual EXH style	5 port base mounted	Type 46	SYJ3000 P. 676	—	●	—	●	—	—	●	—	—	—	—	—
				SYJ3000 P. 676	—	—	—	—	—	—	—	—	—	—	—

Manifold Variations

Manifold Variations	A, B port size							Manifold option				
	M3	M5	1/8	One-touch fittings					Blanking plate	Individual SUP spacer	Individual EXH spacer	Interface regulator
				ø4	ø6	ø8	ø5/32"	ø1/4"				

Flat Ribbon Cable









5 port body ported 	Type 20P	SYJ5000 <small>P. 705</small>	—	●	—	●	●	—	●	●	—	●	—	—	—
	Type 21P		SYJ3000 <small>P. 677</small>	●	—	—	—	—	—	—	—	—	●	—	—
5 port body ported 	Type 21P	SYJ7000 <small>P. 737</small>	—	—	●	—	●	●	—	●	●	●	—	—	—
	Type 32P		SYJ3000 <small>P. 677</small>	—	●	—	●	—	—	●	—	—	●	—	—
4 port base mounted 	Type 32P	SYJ3000 <small>P. 677</small>	—	●	—	●	—	—	●	—	—	●	—	—	—
	Type 41P		SYJ5000 <small>P. 705</small>	—	●	—	—	—	—	—	—	—	●	—	—
5 port base mounted 	Type 41P	SYJ5000 <small>P. 705</small>	—	●	—	—	—	—	—	—	—	●	—	—	—
	Type 43P		SYJ5000 <small>P. 705</small>	—	—	—	●	—	—	●	—	—	●	—	—

- SJ
- SY
- SV
- SYJ
- SZ
- VF
- VP4
- S0700
- VQ
- VQ4
- VQ5
- VQC
- VQC4
- VQZ
- SQ
- VFS
- VFR
- VQ7

Manifold Variations

Manifold Variations	A, B port size						Manifold option					
	M3	M5	1/8	One-touch fittings					Blanking plate	Individual SUP spacer	Individual EXH spacer	Interface regulator
				ø4	ø6	ø8	ø5/32"	ø1/4"				

EX510 Gateway-type Serial Transmission System

5 port body ported  Type 20SA SYJ5000 P. 702	—	●	—	●	●	—	●	●	—	●	—	—	—
5 port body ported  Type 21SA SYJ3000 P. 672	●	—	—	—	—	—	—	—	—	●	—	—	—
5 port body ported  Type 21SA SYJ7000 P. 734	—	—	●	—	●	●	—	●	●	●	—	—	—
4 port base mounted  Type 32SA SYJ3000 P. 675	—	●	—	●	—	—	●	—	—	●	—	—	—
5 port base mounted  Type 41SA SYJ5000 P. 703	—	●	—	—	—	—	—	—	—	●	—	—	—
5 port base mounted  Type 41SA SYJ7000 P. 735	—	—	●	—	—	—	—	—	●	●	—	—	—
5 port base mounted  Type 42SA SYJ5000 P. 703	—	—	●	—	—	—	—	—	—	●	—	—	—
5 port base mounted  Type 43SA SYJ5000 P. 703	—	—	—	●	—	—	●	—	—	●	—	—	—

Manifold option

Individual SUP spacer assembly

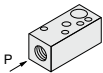

Individual EXH spacer assembly

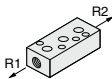

Interface regulator

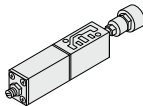

3 port valve and 4/5 port valve mixed mounting

4, 5 port valve 3 port valve

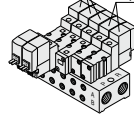





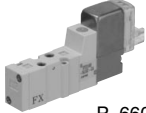

* Refer to page 678 for further information on Series SYJ 3000, page 707 on Series SYJ 5000 and page 739 on Series SYJ7000.

Rubber Seal 4/5 Port Solenoid Valve

Series SYJ3000/5000/7000

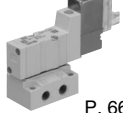
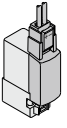
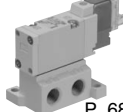
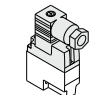
Variations

	Series	Sonic conductance: C [dm ² /(s·bar)]	Type of actuation	Voltage	Electrical entry	Option	Manual override		
						With light/surge voltage suppressor			
Body ported	SYJ3000  P. 660	Effective area 0.9 mm ² { 4/2 → 5/3 { (A/B → EA/EB) }		For DC ■ 24 VDC 12 VDC 6 VDC 5 VDC 3 VDC	Grommet 	For DC ■ With surge voltage suppressor			
	SYJ5000  P. 688	0.47 { 4/2 → 5/3 { (A/B → EA/EB) }						L plug connector 	■ With light/surge voltage suppressor
	SYJ7000  P. 720	2.4 { 4/2 → 5/3 { (A/B → EA/EB) }							
Base mounted	SYJ3000  P. 660	0.46 { 4/2 → 5/3 { (A/B → EA/EB) }	3 Position ● Closed center ● Exhaust center ● Pressure center	For AC ■ 100 VAC ^{50/60} Hz 110 VAC ^{50/60} Hz 200 VAC ^{50/60} Hz 220 VAC ^{50/60} Hz	DIN terminal 	For AC ^{Note)} ■ With light/surge voltage suppressor	■ Non-locking push type		
	SYJ5000  P. 688	0.83 { 4/2 → 5/3 { (A/B → EA/EB) }						(SYJ5000, 7000 only) 	■ Push-turn locking slotted type
	SYJ7000  P. 720	2.9 { 4/2 → 5/3 { (A/B → EA/EB) }							

Note) All AC voltage models have built-in surge voltage suppressor.

- SJ
- SY
- SY
- SV
- SYJ**
- SZ
- VF
- VP4
- S0700
- VQ
- VQ4
- VQ5
- VQC
- VQC4
- VQZ
- SQ
- VFS
- VFR
- VQ7

Rubber Seal 4/5 Port Solenoid Valve

Series SYJ3000



Specifications

Fluid		Air
Operating pressure range (MPa)	2 position single	0.15 to 0.7
	2 position double	0.1 to 0.7
	3 position	0.2 to 0.7
Ambient and fluid temperature (°C)		-10 to 50 (No freezing)
Response time (ms) ^{Note 1)} (at 0.5 MPa)	2 position single, double	15 or less
	3 position	30 or less
Max. operating frequency (Hz)	2 position single, double	10
	3 position	3
Manual override (Manual operation)		Non-locking push type, Push-turn locking slotted type, Push-turn locking lever type
Pilot exhaust method		Individual exhaust for the pilot valve, Common exhaust for the pilot and main valve
Lubrication		Not required
Mounting orientation		Unrestricted
Impact/Vibration resistance (m/s²) ^{Note 2)}		150/30
Enclosure		Dust proof (* M8 connector conforms to IP65.)

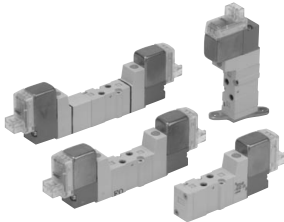

Body ported

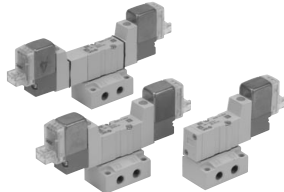

Base mounted

* Based on IEC60529

Note 1) Based on dynamic performance test, JIS B 8375-1981. (Coil temperature: 20°C, at rated voltage, without surge voltage suppressor)

Note 2) Impact resistance: No malfunction occurred when it is tested in the axial direction and at the right angles to the main valve and armature in both energized and de-energized states every once for each condition. (Value in the initial state)

Vibration resistance: No malfunction occurred in one sweep test between 45 and 2000 Hz. Test was performed at both energized and de-energized states in the axial direction and at the right angles to the main valve and armature. (Value in the initial state)

Solenoid Specifications

Symbol

5 port

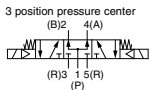
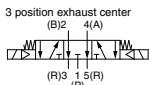
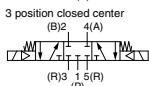
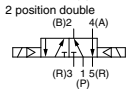
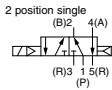

4 port (manifold)

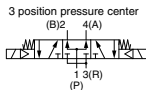
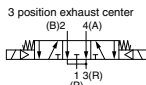
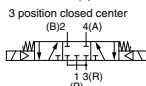
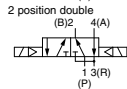
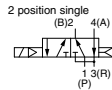

Electrical entry		Grommet (G), (H), L plug connector (L), M plug connector (M), M8 connector (W)	
Coil rated voltage (V)	DC	24, 12, 6, 5, 3	
	AC ^{50/60} Hz	100, 110, 200, 220	
Allowable voltage fluctuation		±10% of rated voltage *	
Power consumption (W)	DC	Standard 0.35 (With light: 0.4)	
	With power saving circuit	0.1 (With light only) * [Starting 0.4, Holding 0.1]	
Apparent power (VA) *	AC	100 V	0.78 (With light: 0.81)
		110 V	0.86 (With light: 0.89)
		[115 V]	[0.94 (With light: 0.97)]
		200 V	1.18 (With light: 1.22)
		220 V [230 V]	1.30 (With light: 1.34) [1.42 (With light: 1.46)]
Surge voltage suppressor		Diode (Non-polarity type: Varistor)	
Indicator light		LED	

* In common between 110 VAC and 115 VAC, and between 220 VAC and 230 VAC.

* For 115 VAC and 230 VAC, the allowable voltage is -15% to +5% of rated voltage.

* For details refer to page 752.

Bracket Mounting

① Insert the lower hook of the mounting bracket into the groove on the bottom of the valve as shown.

② Press the valve and mounting bracket together until the upper hook of the bracket snaps into place in the groove on top of the valve.

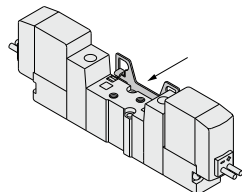
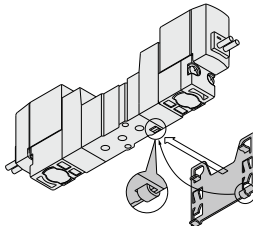

Made to Order
(For details, refer to page 749.)

Flow Characteristics/Weight

Valve model	Type of actuation		Port size		Weight (g) ^{Note 3, 4)}			Effective area (mm ²)	Flow characteristics ^{Note 2)}					
			1, 5, 3 (P, EA, EB)	4, 2 (A, B)	Grommet	L/M plug connector	M8 connector		1→4/2 (P→A/B)			4/2→5/3 (A/B→EA/EB)		
			C [dm ³ /(s·bar)]	b	Cv	C [dm ³ /(s·bar)]	b		Cv					
5 port Base mounted (with sub-plate)	2 position	Single	M5 x 0.8	M5 x 0.8	62 (36) 79 (53)	63 (37) 81 (55)	67 (41) 89 (63)	—	0.46	0.36	0.12	0.46	0.35	0.12
		Double												
	3 position	Closed center												
		Exhaust center												
		Pressure center												
5 port Body ported	2 position	Single	M3 x 0.5	M3 x 0.5	56	58	66	0.9	0.58 [0.32]	0.42 [0.33]	0.16 [0.080]	0.46	0.32	0.11
		Double												
	3 position	Closed center												
		Exhaust center												
		Pressure center												
4 Port Base mounted (For manifold base only)	2 position	Single	1/8	M5 x 0.8	36	37	41	—	—	—	—	—	—	—
		Double												
	3 position	Closed center												
		Exhaust center												
		Pressure center												

Note 1) Dedicated for manifold base. For details, refer to page 670.

Note 2) [] denotes the normal position. Exhaust center: 4/2 → 5/3, Pressure center: 1 → 4/2

Note 3) (): Without sub-plate.

Note 4) For DC voltages. For AC voltages add 3 g to the weight of the single solenoid and 6 g to the weight of the double solenoid and 3 position types.

Cylinder Speed Chart

Use as a guide for selection.
Please confirm the actual conditions with SMC Sizing Program.

Body Ported

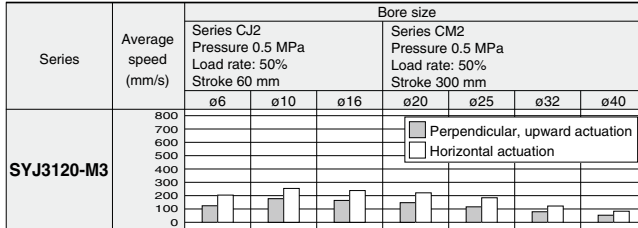

Base Mounted

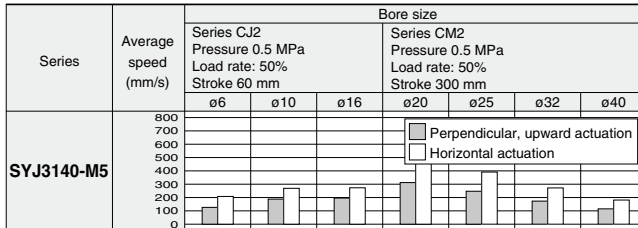

* Cylinder is in extending. Speed controller is meter-out, which is directly connected with cylinder and its needle is fully opened.

* Average speed of cylinder is obtained by dividing the full stroke time by the stroke.

* Load factor: (Load weight x 9.8) / Theoretical force x 100%

Conditions

	Body ported	Series CJ2	Series CM2
SYJ3120-M3	Tubing bore x Length	ø4 x 1 m	
	Speed controller	AS1002F-04	
	Silencer	AN120-M5	

	Base mounted	Series CJ2	Series CM2
SYJ3140-M5	Tubing bore x Length	ø6 x 1 m	
	Speed controller	AS2002F-06	AS2002F-06
	Silencer	AN120-M5	

SJ
SY
SV
SYJ
SZ
VF
VP4
S0700
VQ
VQ4
VQ5
VQC
VQC4
VQZ
SQ
VFS
VFR
VQ7



Type of actuation

1	2 position single solenoid
2	2 position double solenoid
3	3 position closed center
4	3 position exhaust center
5	3 position pressure center

Light/Surge voltage suppressor

Nil	Without light/surge voltage suppressor
S	With surge voltage suppressor
Z	With light/surge voltage suppressor
R	With surge voltage suppressor (Non-polar type)
U	With light/surge voltage suppressor (Non-polar type)

- * For AC voltage valves there is no "S" option. It is already built-in to the rectifier circuit.
- * For type "R" and "U", DC voltage is only available.
- * Power saving circuit is only available in the "Z" type.

Bracket

Nil: Without bracket
F: With bracket

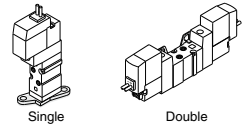

* Brackets cannot be retrofitted.

- Note) • The double solenoid mounting bracket is supplied unattached.
• To order the double solenoid bracket for use with a single solenoid valve, order the single solenoid valve without a bracket and order the bracket (VJ3000-13-1) separately.
(Example) SYJ3120-5M-M3 VJ3000-13-1

5 port

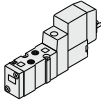

(Type 20 Manifold)

Rated voltage

DC	CE-compliant	AC (50/60 Hz)	CE-compliant
5	24 VDC ●	1	100 VAC —
6	12 VDC ●	2	200 VAC —
V	6 VDC ●	3	110 VAC [115 VAC] —
S	5 VDC ●	4	220 VAC [230 VAC] —
R	3 VDC ●		

- * For type W□, DC voltage is only available.
- Note) CE-compliant: For DC only.

Body ported

SYJ3 1 2 0 □ - 5 M □ □ - M3 - □ □

Base mounted
(4 port)

SYJ3 2 3 0 □ - 5 M □ □ - □ □ (Manifold use only)

Base mounted
(5 port)

SYJ3 2 4 0 □ - 5 M □ □ - □ □

4 port

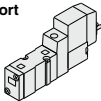

(For manifold type 31, S31, 32, S32)

5 port

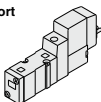

(For sub-plate, manifold type 41, S41, 46, S46)

Coil specifications

Nil	Standard
T	With power saving circuit (24, 12 VDC only)

- * Power saving circuit is not available in the case of W□ type.

Body option

- 0: Pilot valve individual exhaust for the pilot valve
- 3: Common exhaust type for main and pilot valve

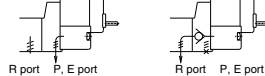

Manual override

Nil: Non-locking push type

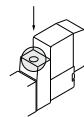

D: Push-turn locking slotted type

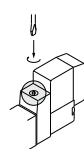

E: Push-turn locking lever type

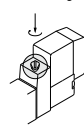

Port size

Nil: Without sub-plate

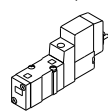

(With gasket and screws)

M5: With M5 port sub-plate

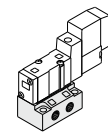

Electrical entry

24, 12, 6, 5, 3 VDC 100, 110, 200, 220 VAC		24, 12, 6, 5, 3 VDC	
Grommet	L plug connector	M plug connector	M8 connector
G: Lead wire length 300 mm	L: With lead wire (Length 300 mm)	M: With lead wire (Length 300 mm)	WO: Without connector cable
H: Lead wire length 600 mm	LN: Without lead wire	LO: Without connector	MO: Without connector
			W□: With connector cable (Note 1)

- * LN, MN type: with 2 sockets.
- * Refer to page 751 for the lead wire length of L and M plug connectors.
- * Refer to page 754 for the connector assembly with cover for L and M plug connectors.
- * For connector cable of M8 connector, refer to page 754.
- * M8 thread conforming to IEC60947-5-2 standard is also available. Refer to page 749 for details.
- Note 1) Enter the cable length symbols in □. Please be sure to fill in the blank referring to page 754.

- Note) When placing an order for body ported solenoid valve as a single unit, mounting screws for manifold and gasket are not attached. Order them separately, if necessary. (For details, refer to page 678.)

CE-compliant

Nil	—
Q	CE-compliant

Note) CE-compliant: For DC only.

Construction

2 position single

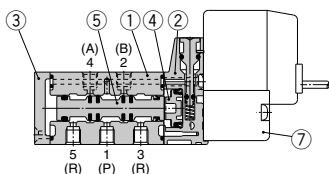
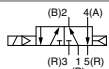

2 position double

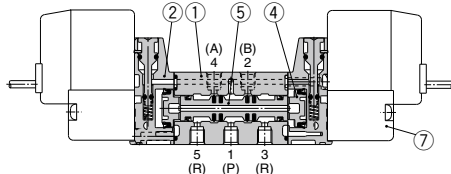

3 position closed center/Exhaust center/Pressure center

3 position closed center

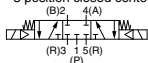

3 position exhaust center

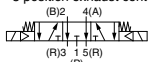

3 position pressure center

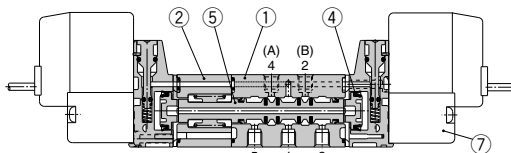
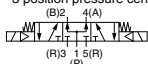

(This figure shows a closed center type.)

Component Parts

No.	Description	Material	Note
1	Body	Zinc die-casted	White
2	Piston plate	Resin	White
3	End cover	Resin	White
4	Piston	Resin	
5	Spool valve assembly	Aluminum, H-NBR	

Replacement Parts

No.	Description	Part no.	Note
6	Sub-plate ^(Note)	SYJ3000-22-1 (-Q)	Zinc die-casted
7	Pilot valve	V111 (T) - □ □ □	

(Note) Add suffix "-Q" for the CE-compliant product.

How to Order Pilot Valve Assembly

V111 □ — 5 G □

Coil specifications

NH	Standard
T	With power saving circuit (24, 12 VDC only)

* Power saving circuit is not available in the case of W□ type.

Light/Surge voltage suppressor

NH	Without light/surge voltage suppressor
S	With surge voltage suppressor
Z	With light/surge voltage suppressor
R	With surge voltage suppressor (Non-polar type)
U	With light/surge voltage suppressor (Non-polar type)

* For AC voltage valves there is no "S" option. It is already built-in to the rectifier circuit.
* For type "R" and "U", DC voltage is only available.
* Power saving circuit is only available in the "Z" type.

Rated voltage

5	24 VDC
6	12 VDC
V	6 VDC
S	5 VDC
R	3 VDC
1	100 VAC 50/60 Hz
2	200 VAC 50/60 Hz
3	110 VAC 50/60 Hz [115 VAC 50/60 Hz]
4	220 VAC 50/60 Hz [230 VAC 50/60 Hz]

* For type W□, DC voltage is only available.
* CE-compliant: For DC only.

Electrical entry

G	Grommet, 300 mm lead wire
H	Grommet, 600 mm lead wire
L	L plug connector
LN	With lead wire
LO	Without lead wire
M	M plug connector
MN	With lead wire
MO	Without lead wire
WO	Without connector
WQ	M8 Without connector cable
W□	With connector cable ^(Note 1)

* For connector cable of M8 connector, refer to page 754.
Note 1) Enter the cable length symbols in □. Please be sure to fill in the blank referring to page 754.

(Note) Since V111 is CE-compliant as standard, the suffix "-Q" is not necessary.

SJ
SY
SY
SV
SYJ
SZ
VF
VP4
S0700
VQ
VQ4
VQ5
VQC
VQC4
VQZ
SQ
VFS
VFR
VQ7

Series SYJ3000

2 Position Single

* []: AC

Grommet (G), (H): SYJ3120-□^G□□-M3

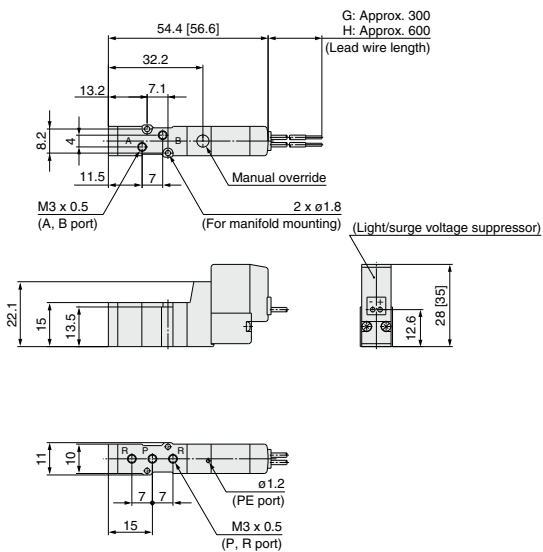

With bracket:
SYJ3120-□^G□□-M3-F

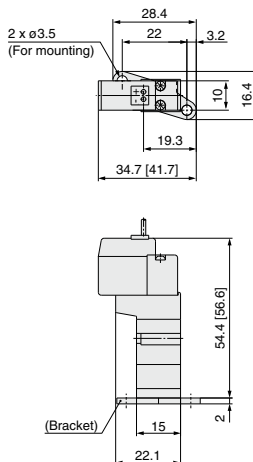

L plug connector (L):
SYJ3120-□L□□-M3 (-F)

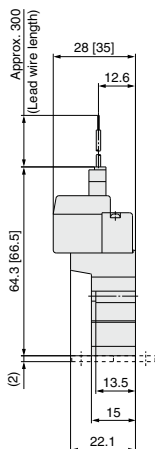

M plug connector (M):
SYJ3120-□M□□-M3 (-F)

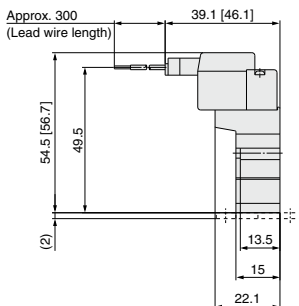

M8 connector (WO):
SYJ3120-□WO□□-M3 (-F)

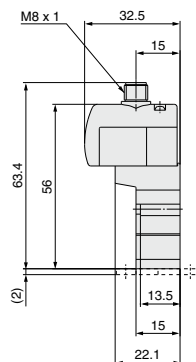

* Refer to page 755 for dimensions with connector cable.

2 Position Double

* []: AC

Grommet (G), (H): SYJ3220-□^G□□-M3 (-F)

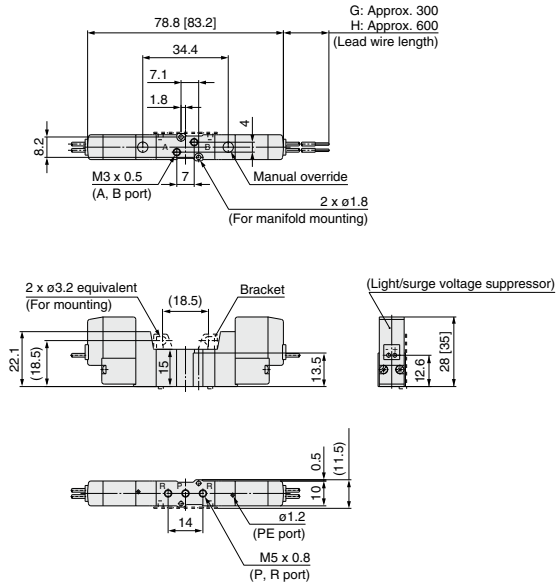

L plug connector (L):
SYJ3220-□L□□-M3 (-F)

M plug connector (M):
SYJ3220-□M□□-M3 (-F)

M8 connector (WO):
SYJ3220-□WO□□-M3 (-F)

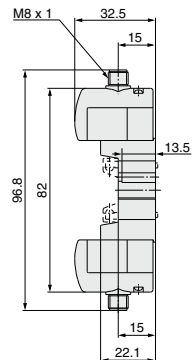
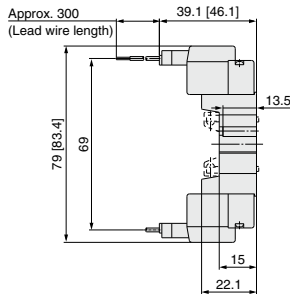
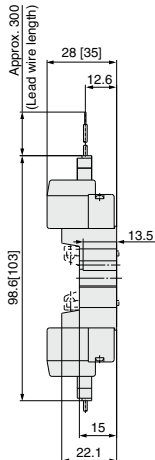

* Refer to page 755 for dimensions with connector cable.

SJ
SY
SY
SV
SYJ
SZ
VF
VP4
S0700
VQ
VQ4
VQ5
VQC
VQC4
VQZ
SQ
VFS
VFR
VQ7

Series SYJ3000

3 Position Closed Center/Exhaust Center/Pressure Center

* []: AC

Grommet (G), (H): SYJ3 $\frac{3}{4}$ 20-□□□-M3 (-F)

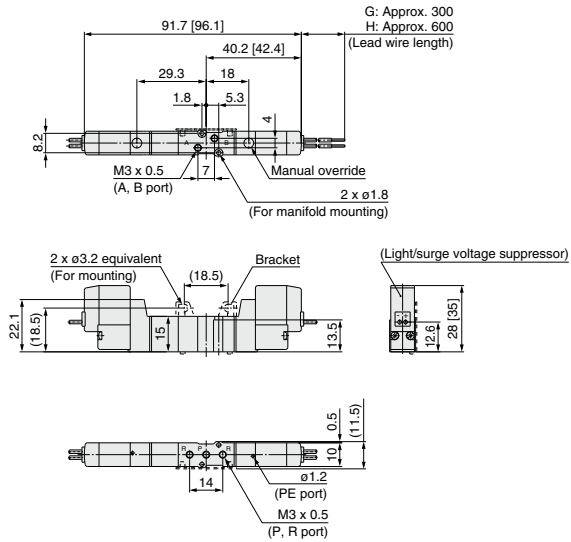

L plug connector (L):
SYJ3 $\frac{3}{4}$ 20-□□□-M3 (-F)

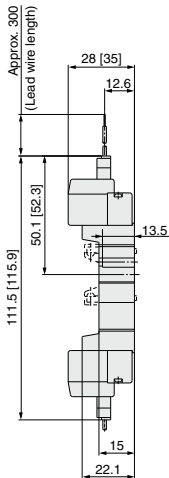

M plug connector (M):
SYJ3 $\frac{3}{4}$ 20-□□□-M3 (-F)

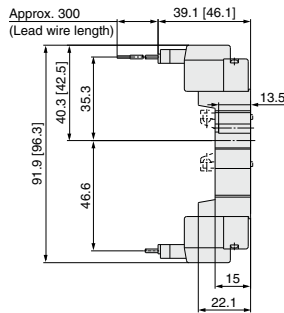

M8 connector (WO):
SYJ3 $\frac{3}{4}$ 20-□WO□□-M3 (-F)

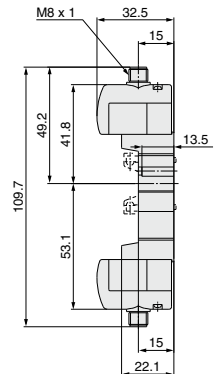

* Refer to page 755 for dimensions with connector cable.

2 Position Single

* []: AC

Grommet (G), (H): SYJ3140-□□^G□□-M5

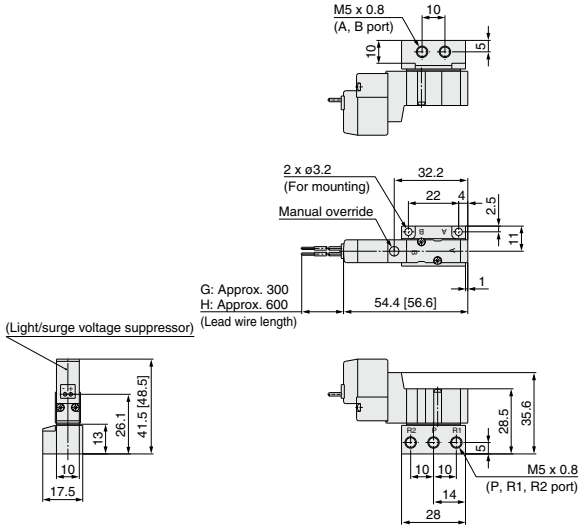

L plug connector (L):
SYJ3140-□□L□□-M5

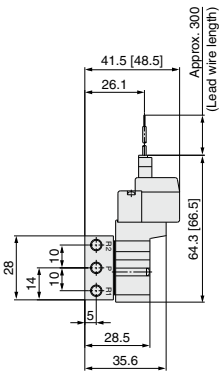

M plug connector (M):
SYJ3140-□□M□□-M5

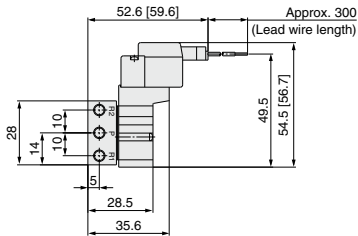

M8 connector (WO):
SYJ3140-□□WO□□-M5

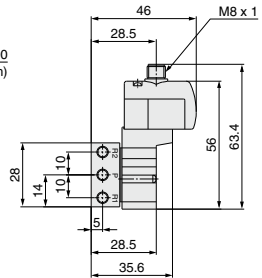

* Refer to page 755 for dimensions with connector cable.

- SJ
- SY
- SY
- SV
- SYJ**
- SZ
- VF
- VP4
- S0700
- VQ
- VQ4
- VQ5
- VQC
- VQC4
- VQZ
- SQ
- VFS
- VFR
- VQ7

Series SYJ3000

2 Position Double

* []: AC

Grommet (G), (H): SYJ3240-□^G_H□□-M5

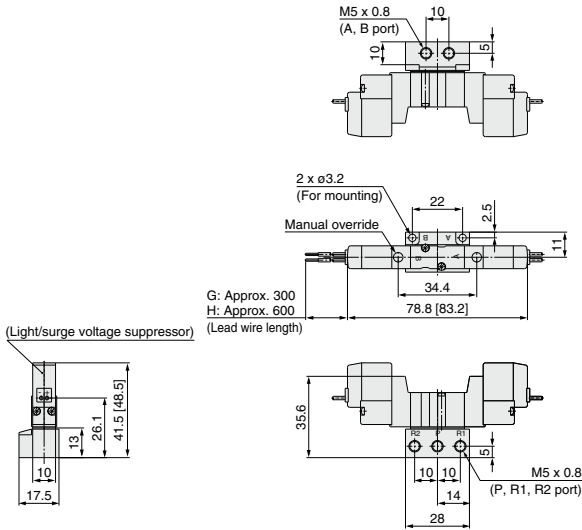

L plug connector (L):
SYJ3240-□L□□-M5

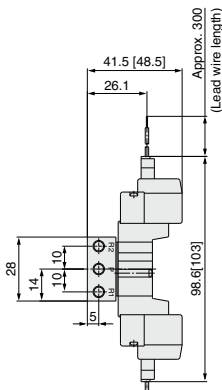

M plug connector (M):
SYJ3240-□M□□-M5

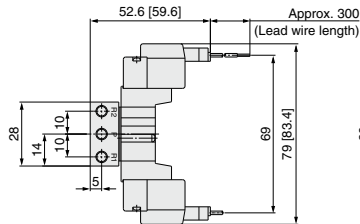

M8 connector (WO):
SYJ3240-□WO□□-M5

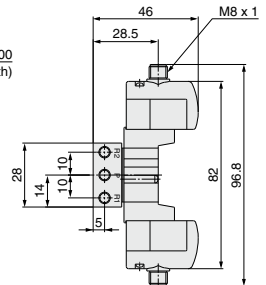

* Refer to page 755 for dimensions with connector cable.

3 Position Closed Center/Exhaust Center/Pressure Center

* []: AC

Grommet (G), (H): SYJ3^{3/4}₀-□^G□^H□□-M5

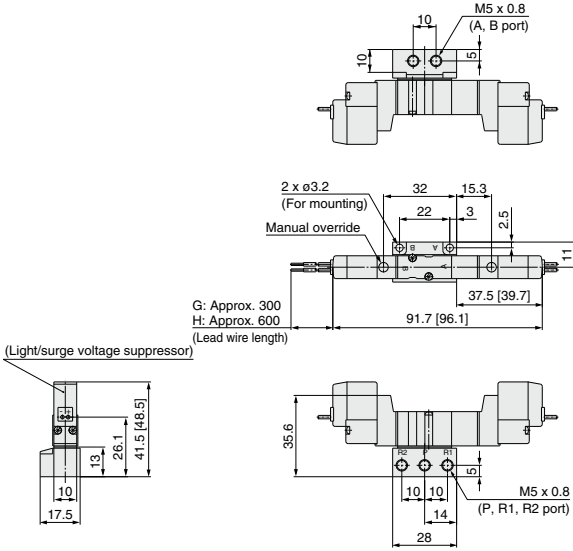

L plug connector (L):
SYJ3^{3/4}₀-□L□□-M5

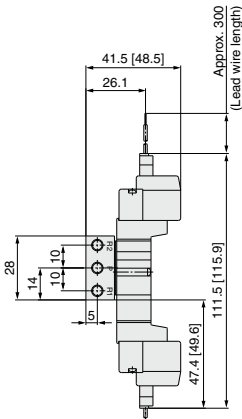

M plug connector (M):
SYJ3^{3/4}₀-□M□□-M5

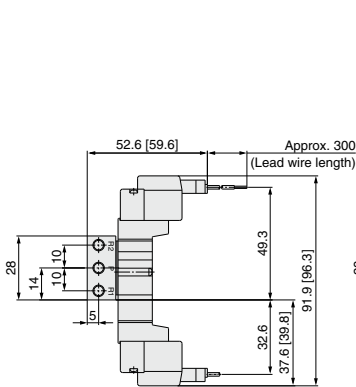

M8 connector (WO):
SYJ3^{3/4}₀(R)-□WO□□-M5□

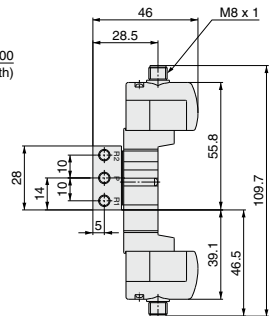

* Refer to page 755 for dimensions with connector cable.

SJ
SY
SY
SV
SYJ
SZ
VF
VP4
S0700
VQ
VQ4
VQ5
VQC
VQC4
VQZ
SQ
VFS
VFR
VQ7

Manifold Standard

Manifold Specifications

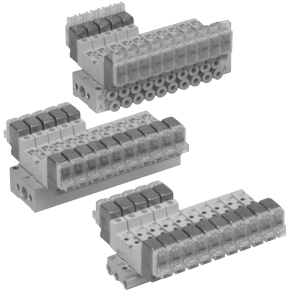

Model		Type 20	Type 31, S31	Type 32, S32	Type 41, S41	Type 46, S46
Manifold type		Single base/B mount				
P (SUP), R (EXH)		Common SUP/Common EXH				Common SUP Individual EXH
Valve stations		2 to 20 stations				
A, B port Porting specifications	Location	Valve	Base			
	Direction	Top	Side			
Port size	P, R port	M5 x 0.8		1/8		P: 1/8 R: M5 x 0.8
	A, B port	M3 x 0.5		M5 x 0.8, C4 (One-touch fitting for ø4)		

Flow Characteristics

Manifold			Port size		Flow characteristics						Effective area (mm ²)	
					1→4/2 (P→A/B)			4/2→5/3 (A/B→R)				
			f(P), 5/3(R) Port	2(B), 4(A) Port	C [dm ³ /(s·bar)]	b	Cv	C [dm ³ /(s·bar)]	b	Cv		
Body ported for internal pilot	Type SSSYJ3-20	SYJ3□□2□	M5 x 0.8	M3 x 0.5	—	—	—	—	—	—	0.9	
	Type SSSYJ3-31 S31	SYJ3□□3□	M5 x 0.8	M3 x 0.5	—	—	—	—	—	—	0.9	
Base mounted for internal pilot	Type SSSYJ3-32-M5	SYJ3□□3□	M5 x 0.8	1/8	M5 x 0.8	0.25	0.19	0.060	0.32	0.25	0.077	—
	Type SSSYJ3-32-C4				C4	0.25	0.18	0.059	0.30	0.27	0.075	—
	Type SSSYJ3-32-M5				M5 x 0.8	0.25	0.26	0.060	0.29	0.15	0.062	—
	Type SSSYJ3-32-C4				C4	0.24	0.21	0.057	0.27	0.18	0.062	—
	Type SSSYJ3-41-M5	SYJ3□□4□	M5 x 0.8	1/8	M5 x 0.8	0.32	0.25	0.081	0.33	0.19	0.079	—
	Type SSSYJ3-41-C4				C4	0.32	0.28	0.079	0.35	0.24	0.084	—
	Type SSSYJ3-41-M5				M5 x 0.8	0.33	0.29	0.082	0.34	0.17	0.081	—
	Type SSSYJ3-41-C4				C4	0.32	0.27	0.079	0.34	0.24	0.084	—
	Type SSSYJ3-46-M5	SYJ3□□4□	M5 x 0.8	1/8	M5 x 0.8	0.20	0.25	0.048	0.10	0.12	0.024	—
	Type SSSYJ3-46-C4				C4	0.21	0.27	0.050	0.21	0.13	0.047	—
	Type SSSYJ3-46-M5				M5 x 0.8	0.20	0.25	0.048	0.19	0.16	0.024	—
	Type SSSYJ3-46-C4				C4	0.22	0.34	0.057	0.10	0.090	0.024	—

Note) Value at manifold base mounted, 2 position single operating

How to Order Manifold (Example)

Instruct by specifying the valves and blanking plate assembly to be mounted on the manifold along with the manifold base model no.

Example:

- SS5YJ3-20-03 1 set (Manifold base)
- SS5YJ3-S41-03-C4 ... 1 set (Manifold base)
- * SYJ3120-5G-M3 ... 2 sets (Valve)
- * SYJ3140-5LZ 2 sets (Valve)
- * SYJ3000-21-12A ... 1 set (Blanking plate assembly)
- * SYJ3000-21-12A ... 1 set (Blanking plate assembly)

↳ The asterisk denotes the symbol for assembly. Prefix it to the part nos. of the solenoid valve, etc.

* Use manifold specification sheet.



Note) CE-compliant:
For DC only. [Option]

Flat Ribbon Cable Manifold

- Multiple valve wiring is simplified through the use of the flat cable connector.
- Clean appearance

In the case of a flat ribbon cable type, each valve is wired on the print board of manifold base to allow the external wiring to be piped all together with 26 pins MIL connector.

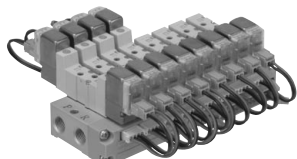

Type 21P

Flat Ribbon Cable Manifold Specifications

Model		Type 21P	Type 32P
Manifold type		Single base/B mount	
P (SUP), R (EXH)		Common SUP, Common EXH	
Valve stations		4 to 12 stations	
A, B port	Location	Valve	Base
Porting specifications	Direction	Top	Side
P, R port		1/8	
Port size	A, B port	M3 x 0.5	M5 x 0.8, C4 (One-touch fitting for Ø4)
Applicable flat ribbon cable connector		Socket: 26 pins MIL type with strain relief (MIL-C-83503)	
Internal wiring		In common between +COM and -COM (Z type: +COM only)	
Rated voltage <small>Note 2)</small>		24, 12 VDC/100, 110 VAC	

Note 1) The withstand voltage specification for the wiring unit section conforms to JIS C 0704, Grade 1 or its equivalent.
Note 2) CE-compliant: For DC only.

Flow Characteristics

Manifold		Port size		Flow characteristics						Effective area (mm ²)		
		1(P), 5Ø(R) Port	2(B), 4(A) Port	1→4/2 (P→A/B)			4/2→5/3 (A/B→R)					
		C	b	Cv	C	b	Cv					
Body ported for internal pilot	Type SSSYJ3-21P	SYJ3□23	1/8	M3 x 0.5	—	—	—	—	—	—	—	0.9
Base mounted for internal pilot	Type SSSYJ3-32P-M5	SYJ3□33	1/8	M5 x 0.8	0.25	0.19	0.060	0.32	0.25	0.077	—	—
	Type SSSYJ3-32P-C4			C4	0.25	0.18	0.059	0.3	0.27	0.075	—	—

Note) Value at manifold base mounted, 2 position single operating

How to Order Manifold

- SS5YJ3-32P-07-C4 (-Q) 1 pc. (Manifold base) * SYJ3000-21-13A (-Q) 1 pc. (Blanking plate assembly)
- SYJ3133-5LOU (-Q) 3 pcs. (Valve) * SY3000-37-28A 3 pcs. (Connector assembly)
- SYJ3233-5LOU (-Q) 3 pcs. (Valve) * SY3000-37-29A 3 pcs. (Connector assembly)

The asterisk denotes the symbol for assembly. Prefix it to the part nos. of the solenoid valve, etc.

Note) Please indicate the connector assembly part no. below that connects the valve and the manifold.

How to Order Valve

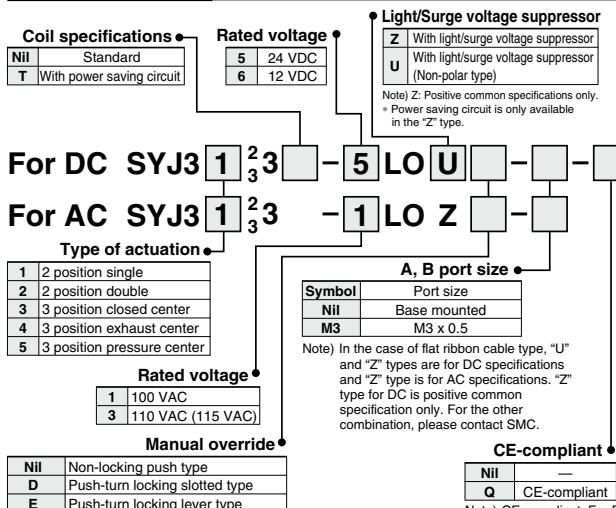

Connector Assembly

For 12, 24 VDC

Single solenoid	SY3000-37-28A
Double solenoid, 3 position type	SY3000-37-29A

For 100 VAC

Single solenoid	SY3000-37-46A
Double solenoid, 3 position type	SY3000-37-47A

For 110 VAC (115 VAC)

Single solenoid	SY3000-37-54A
Double solenoid, 3 position type	SY3000-37-55A

SJ

SY

SY

SV

SYJ

SZ

VF

VP4

S0700

VQ

VQ4

VQ5

VQC

VQC4

VQZ

SQ

VFS

VFR

VQ7

EX510 Gateway-type Serial Transmission System

Manifold for EX510 Serial Wiring Specifications

Model		Type 21SA	Type 32SA
Manifold type		Single base/B mount	
P (SUP), R (EXH)		Common SUP, Common EXH	
Valve stations		4 to 16 stations	
A, B port Porting specifications	Location	Valve	Base
	Direction	Top	Side
Port size	P, R port	1/8	
	A, B port	M3 x 0.5	M5 x 0.8, C4 (One-touch fitting for Ø4)
Rated voltage		24 VDC	

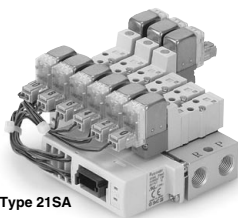

Type 21SA

Flow Characteristics

Manifold			Port size		Flow characteristics						Effective area area (mm ²)
					1→4/2 (P→A/B)			4/2→5/3 (A/B→R)			
			1(P), 5/3(R) Port	2(B), 4(A) Port	C [dm ³ /(s·bar)]	b	Cv	C [dm ³ /(s·bar)]	b	Cv	
Body ported for internal pilot	Type S55YJ3-21SA	SYJ3□23	1/8	M3 x 0.5	—	—	—	—	—	—	0.9
Base mounted for internal pilot	Type S55YJ3-32SA-M5	SYJ3□33	1/8	M5 x 0.8	0.25	0.19	0.060	0.32	0.25	0.077	—
	Type S55YJ3-32SA-C4			C4	0.25	0.18	0.059	0.3	0.27	0.075	—

Note) Value at manifold base mounted, 2 position single operating

How to Order Manifold

S55YJ3-21SA-06..... 1 set (Type 21SA 6 stations manifold part no.)

* SYJ3123-5LOU-M3..... 4 sets (Single solenoid part no.)

* SYJ3223-5LOU-M3..... 2 sets (Double solenoid part no.)

↳ The asterisk denotes the symbol for assembly. Prefix it to the part nos. of the solenoid valve, etc.

Add the valve and option part numbers under the manifold base part number. In the case of complex arrangement, specify them on the manifold specification sheet. The connector assembly lead wire length used for EX510 manifold varies depending on the number of stations. Therefore, solenoid valves (including a blanking plate) and connector assembly are assembled when shipped as a standard specification. Please specify the mounting solenoid valve when ordering.

SJ
SY
SY
SV
SYJ
SZ
VF
VP4
S0700
VQ
VQ4
VQ5
VQC
VQC4
VQZ
SQ
VFS
VFR
VQ7

EX510 Gateway-type Serial Transmission System Body Ported Manifold

Series SYJ3000



How to Order Manifold

SS5YJ3 - 21SA [] - 04 - [] - []

SI unit

Nil	NPN output (+ COM.)
N	PNP output (- COM.)

CE-compliant

Nil	—
Q	CE-compliant

Valve stations

Symbol	Station	Note
04	4 stations	Double wiring (Note 1)
:	:	
08	8 stations	Specified layout (Note 2) (Up to 16 solenoids)
04	4 stations	
:	:	
16	16 stations	

The number of the blanking plate assembly is also included.
 Note 1) Double wiring: Use of a single solenoid will result in an unused control signal. If this is not desired, order with a specified layout.
 Note 2) Specified layout: Indicate wiring specifications on the manifold specification sheet. (Note that double and 3 position valves cannot be used where single solenoid wiring has been specified.)

P, R port thread type

Nil	Rc
00F	G
00N	NPT
00T	NPTF

SI unit part no.

Symbol	SI unit specifications	SI unit part no.	Page
Nil	NPN output (+ COM.)	EX510-S001	P.2143
N	PNP output (- COM.)	EX510-S101	

Refer to page 2124 and the Operation Manual for the details of EX510 Gateway-type Serial Transmission System. Please download the Operation Manual via our website, <http://www.smcworld.com>

How to Order Valve

SYJ3 [] 23 [] - 5LO [] - M3 - []

Type of actuation

1	2 position single
2	2 position double
3	3 position closed center
4	3 position exhaust center
5	3 position pressure center

Coil specifications

Nil	Standard
T	With power saving circuit

Rated voltage: 24 VDC

Light/Surge voltage suppressor

Z	With light/surge voltage suppressor
U	Without light/surge voltage suppressor (non-polar type)

* Power saving circuit is only available in the "Z" type.

Manual override

Nil	Non-locking push type
D	Push-turn locking slotted type
E	Push-turn locking lever type

CE-compliant

Nil	—
Q	CE-compliant

A, B port size

How to Order Manifold Assembly (Example)

Example

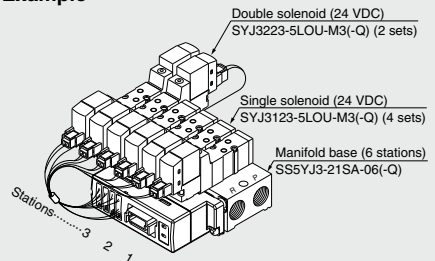

SS5YJ3-21SA-06 (-Q).....1 set (Type 21SA 6-station manifold part no.)
 *SYJ3123-5LOU-M3 (-Q).....4 sets (Single solenoid part no.)
 *SYJ3223-5LOU-M3 (-Q).....2 sets (Double solenoid part no.)

The asterisk denotes the symbol for assembly. Prefix it to the part nos. of the solenoid valve, etc.

Add the valve and option part numbers under the manifold base part number. In the case of complex arrangement, specify them on the manifold specification sheet. The connector assembly lead wire length used for EX510 manifold varies depending on the number of stations. Therefore, solenoid valves (including a blanking plate) and connector assembly are assembled when shipped as a standard specification. Please specify the mounting solenoid valve when ordering.

EX510 Gateway-type Serial Transmission System Base Mounted Manifold

Series SYJ3000



How to Order Manifold

SS5YJ3 - 32SA [] - 04 - M5 [] - []

SI unit

Nil	NPN output (+ COM.)
N	PNP output (- COM.)

Valve stations

Symbol	Station	Note
04	4 stations	Double wiring <i>Note 1)</i>
:	:	
08	8 stations	Specified layout <i>Note 2)</i> (Up to 16 solenoids)
04	4 stations	
:	:	
16	16 stations	

* The number of the blanking plate assembly is also included.
 Note 1) Double wiring: Use of a single solenoid will result in an unused control signal. If this is not desired, order with a specified layout.
 Note 2) Specified layout: Indicate wiring specifications on the manifold specification sheet. (Note that double and 3 position valves cannot be used where single solenoid wiring has been specified.)

CE-compliant

Nil	—
Q	CE-compliant

P, R port thread type

Nil	Rc
F	G
N	NPT
T	NPTF

A, B port size

M5	M5 x 0.8
C4	One-touch fitting for ø4
N3	One-touch fitting for ø5/32"

SI unit part no.

Symbol	SI unit specifications	SI unit part no.	Page
Nil	NPN output (+ COM.)	EX510-S001	P.2143
N	PNP output (- COM.)	EX510-S101	

Refer to page 2124 and the Operation Manual for the details of EX510 Gateway-type Serial Transmission System. Please download the Operation Manual via our website, <http://www.smcworld.com>

How to Order Valve

SYJ3 1 33 [] - 5LO Z [] - []

Type of actuation

1	2 position single
2	2 position double
3	3 position closed center
4	3 position exhaust center
5	3 position pressure center

Coil specifications

Nil	Standard
T	With power saving circuit

Rated voltage: 24 VDC

Light/Surge voltage suppressor

Z	With light/surge voltage suppressor
U	Without light/surge voltage suppressor (non-polar type)

* Power saving circuit is only available in the "Z" type.

Manual override

Nil	Non-locking push type
D	Push-turn locking slotted type
E	Push-turn locking lever type

CE-compliant

Nil	—
Q	CE-compliant

How to Order Manifold Assembly (Example)

Example

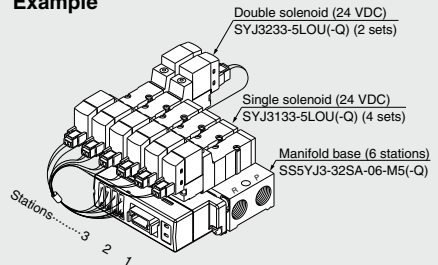

SS5YJ3-32SA-06-M5 (-Q).....1 set (Type 32SA 6-station manifold part no.)
 * SYJ3133-5LOU (-Q).....4 sets (Single solenoid part no.)
 * SYJ3233-5LOU (-Q).....2 sets (Double solenoid part no.)

— The asterisk denotes the symbol for assembly. Prefix it to the part nos. of the solenoid valve, etc.

Add the valve and option part numbers under the manifold base part number. In the case of complex arrangement, specify them on the manifold specification sheet. The connector assembly lead wire length used for EX510 manifold varies depending on the number of stations. Therefore, solenoid valves (including a blanking plate) and connector assembly are assembled when shipped as a standard specification. Please specify the mounting solenoid valve when ordering.

- SJ
- SY
- SV
- SYJ
- SZ
- VF
- VP4
- S0700
- VQ
- VQ4
- VQ5
- VQC
- VQC4
- VQZ
- SQ
- VFS
- VFR
- VQ7

Common SUP/Common EXH

Note) For more than 10 stations, supply air to both sides of P port and exhaust air from both sides of R port. Except 41 type

Type 20 (5 port/Body ported)

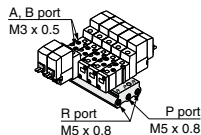

How to Order

SS5YJ3-20-05-

Number of stations

02	2 stations
:	:
20	20 stations

Nil	—
Q	CE-compliant

Applicable solenoid valve
SYJ3□20-□□□□-M3(-Q)
SYJ3□23-□□□□-M3(-Q)

Applicable blanking plate assembly
Refer to page 679.

Type 31 (4 port/Base mounted)

Type 31 Type S31 (Single solenoid pilot valve is on same side as the A,B port.)

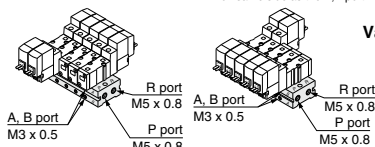

How to Order

SS5YJ3-31-05-M3-

Valve mounting direction

Nil	Single solenoid pilot valve is on opposite side as the A,B port.
S	Single solenoid pilot valve is on same side as the A,B port.

Stations

02	2 stations
:	:
20	20 stations

Nil	—
Q	CE-compliant

Applicable solenoid valve
SYJ3□30-□□□□(-Q)
SYJ3□33-□□□□(-Q)

Applicable blanking plate assembly
Refer to page 679.

Type 32 (4 port/Base mounted)

Type 32 Type S32 (Single solenoid pilot valve is on same side as the A,B port.)

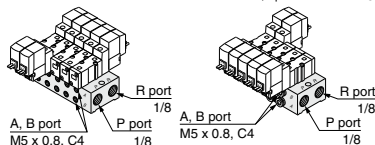

How to Order

SS5YJ3-32-05-M5-

Valve mounting direction

Nil	Single solenoid pilot valve is on opposite side as the A,B port.
S	Single solenoid pilot valve is on same side as the A,B port.

Stations

02	2 stations
:	:
20	20 stations

A, B port size

M5	M5 x 0.8
C4	One-touch fitting for ø4
N3	One-touch fitting for ø5/32"

Nil	—
Q	CE-compliant

P, R port thread type

Nil	Rc
F	G
N	NPT
T	NPTF

Type 41 (5 port/Base mounted)

Type 41 Type S41 (Single solenoid pilot valve is on same side as the A,B port.)

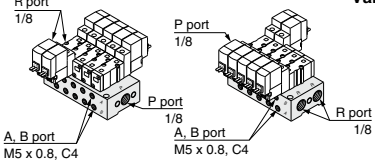

How to Order

SS5YJ3-41-05-C4-

Valve mounting direction

Nil	Single solenoid pilot valve is on opposite side as the A,B port.
S	Single solenoid pilot valve is on same side as the A,B port.

Stations

02	2 stations
:	:
20	20 stations

A, B port size

M5	M5 x 0.8
C4	One-touch fitting for ø4
N3	One-touch fitting for ø5/32"

Nil	—
Q	CE-compliant

P, R port thread type

Nil	Rc
F	G
N	NPT
T	NPTF

Applicable solenoid valve
SYJ3□40-□□□□(-Q)
SYJ3□43-□□□□(-Q)

Applicable blanking plate assembly
Refer to page 679.

Common SUP/Individual EXH

Note) For more than 10 stations, supply air to both sides of P port.

Type 46 (5 port/Base mounted)

Type 46 Type S46 (Single solenoid pilot valve is on same side as the A,B port.)

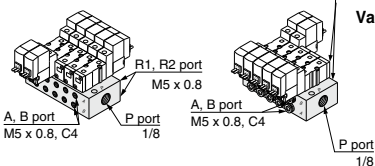

How to Order

SS5YJ3-46-05-M5-

Valve mounting direction

Nil	Single solenoid pilot valve is on opposite side as the A,B port.
S	Single solenoid pilot valve is on same side as the A,B port.

Stations

02	2 stations
:	:
20	20 stations

A, B port size

M5	M5 x 0.8
C4	One-touch fitting for ø4
N3	One-touch fitting for ø5/32"

Nil	—
Q	CE-compliant

P port thread type

Nil	Rc
F	G
N	NPT
T	NPTF

Applicable solenoid valve
SYJ3□40-□□□□(-Q)
SYJ3□43-□□□□(-Q)

Applicable blanking plate assembly
Refer to page 679.



Flat Ribbon Cable Manifold

Note) CE-compliant:
For DC only.

[Option]

Common SUP/Common EXH

Note) For more than 10 stations, supply air to both sides of P port and exhaust air from both sides of R port.

Type 21P (5 port/Body ported)

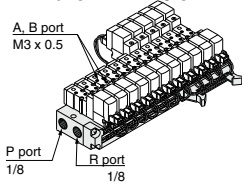

How to Order
SS5YJ3-21P-07-□-□-□

Stations

04	4 stations
:	:
12	12 stations

P, R port thread type

Nil	Rc
00F	G
00N	NPT
00T	NPTF

CE-compliant

Nil	—
Q	CE-compliant

Applicable solenoid valve
Refer to page 671.

Applicable connector assembly
Refer to page 671.

Applicable blanking plate assembly
Refer to page 679.

Type 32P (4 port/Base mounted)

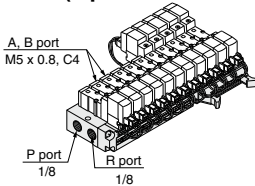

How to Order
SS5YJ3-32P-07-C4-□-□-□

Stations

04	4 stations
:	:
12	12 stations

A, B port size

M5	M5 x 0.8
C4	One-touch fitting for ø4
N3	One-touch fitting for ø5/32"

P, R port thread type

Nil	Rc
F	G
N	NPT
T	NPTF

CE-compliant

Nil	—
Q	CE-compliant

Applicable solenoid valve
Refer to page 671.

Applicable connector assembly
Refer to page 671.

Applicable blanking plate assembly
Refer to page 679.

EX510 Gateway-type Serial Transmission System

Type 21SA (5 port/Body ported)

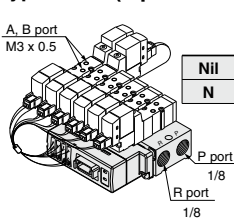

How to Order
SS5YJ3-21SA-□-04-□-□-□

SI unit

Nil	NPN output (+ COM.)
N	PNP output (- COM.)

Valve stations

Symbol	Station	Note
04	4 stations	Double wiring ^{Note 1)}
:	:	
08	8 stations	Specified layout ^{Note 2)} (Up to 16 solenoids)
04	4 stations	
:	:	
16	16 stations	

P, R port thread type

Nil	Rc
00F	G
00N	NPT
00T	NPTF

CE-compliant

Nil	—
Q	CE-compliant

Applicable solenoid valve
Refer to page 672.

Applicable blanking plate assembly
Refer to page 679.

The number of the blanking plate assembly is also included.
Note 1) Double wiring: Use of a single solenoid will result in an unused control signal. If this is not desired, order with a specified layout.
Note 2) Specified layout: Indicate wiring specifications on the manifold specification sheet. (Note that double and 3 position valves cannot be used where single solenoid wiring has been specified.)

Type 32SA (4 port/Base mounted)

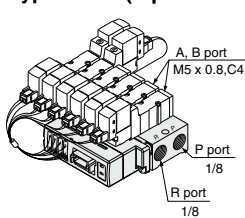

How to Order
SS5YJ3-32SA-□-04-M5-□-□-□

SI unit

Nil	NPN output (+ COM.)
N	PNP output (- COM.)

Valve stations

Symbol	Station	Note
04	4 stations	Double wiring ^{Note 1)}
:	:	
08	8 stations	Specified layout ^{Note 2)} (Up to 16 solenoids)
04	4 stations	
:	:	
16	16 stations	

P, R port thread type

Nil	Rc
F	G
N	NPT
T	NPTF

CE-compliant

Nil	—
Q	CE-compliant

A, B port size

M5	M5 x 0.8
C4	One-touch fitting for ø4
N3	One-touch fitting for ø5/32"

Applicable solenoid valve
Refer to page 672.

Applicable blanking plate assembly
Refer to page 679.

The number of the blanking plate assembly is also included.
Note 1) Double wiring: Use of a single solenoid will result in an unused control signal. If this is not desired, order with a specified layout.
Note 2) Specified layout: Indicate wiring specifications on the manifold specification sheet. (Note that double and 3 position valves cannot be used where single solenoid wiring has been specified.)

SJ
SY
SY
SV
SYJ
SZ
VF
VP4
S0700
VQ
VQ4
VQ5
VQC
VQC4
VQZ
SQ
VFS
VFR
VQ7

Series SYJ3000

Mixed Installation of the SYJ300 and the SYJ3000 Valves on the Same Manifold

Series SYJ300 valves can be mounted on the manifolds for Series SYJ3000.

① SS5YJ3-20, SS5YJ3-21P, SS5YJ3-21SA

The 3 port valve can be used by simply sealing off the unused "R" port with rubber plug SYJ3000-33-1.

Applicable solenoid valves:

Series SYJ312, SYJ312M, SYJ322, SYJ322M

② SS5YJ3-31, -S31, SS5YJ3-32, -S32.

SS5YJ3-32SA, SS5YJ3-46, -S46, SS5YJ3-32P
The 3 port valve can be used without modification. The A port of the valve will flow out of the B port of the manifold.

Applicable solenoid valves:

Series SYJ314, SYJ314M, SYJ324, SYJ324M

③ SS5YJ3-41, -S41

The 3 port valve can be used on the 4 port manifold by simply sealing off the unused "R" port with rubber plug SYJ3000-33-1. The A port of the valve will flow out of the B port of the manifold.

Applicable solenoid valves:

Series SYJ314, SYJ314M, SYJ324, SYJ324M

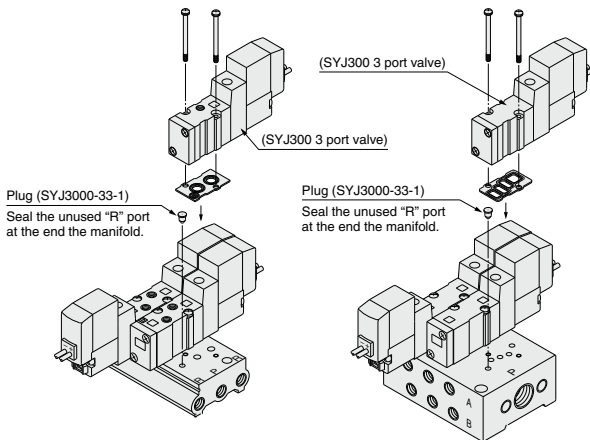

Type SS5YJ3-20

Type SS5YJ3-41

A port of the 3 port valve flows out of the manifold B port.

⚠ Caution

Mounting screw tightening torques

M1.7: 0.12 N·m

Use caution to the assembly orientation for solenoid valves, gasket, and optional parts.

Combinations of Solenoid Valve, Manifold Gasket and Manifold Base

5 port body ported (Type SYJ3□2⁰³ (-Q))

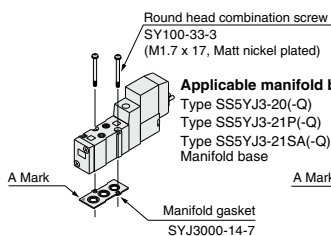

Applicable manifold base
Type SS5YJ3-20(-Q)
Type SS5YJ3-21P(-Q)
Type SS5YJ3-21SA(-Q)
Manifold base

4 port base mounted (Type SYJ3□3⁰³ (-Q))

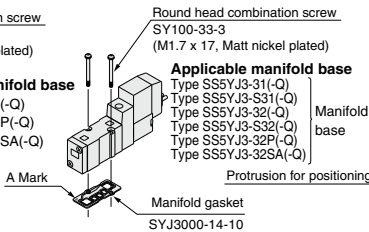

Applicable manifold base
Type SS5YJ3-31(-Q)
Type SS5YJ3-33(-Q)
Type SS5YJ3-32(-Q)
Type SS5YJ3-32P(-Q)
Type SS5YJ3-32SA(-Q)
Manifold base

5 port base mounted (Type SYJ3□4⁰³ (-Q))

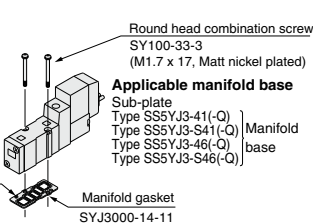

Applicable manifold base
Sub-plate
Type SS5YJ3-41(-Q)
Type SS5YJ3-S41(-Q)
Type SS5YJ3-46(-Q)
Type SS5YJ3-S46(-Q)
Manifold base

Note) Make sure to align the manifold gasket with the groove of the valve body.

Difference between SYJ3□3⁰³ and SYJ3□4⁰³

SYJ3□30, 3□33 (4 port)

SYJ3□40, 3□43 (5 port)

Steel ball is driven in.

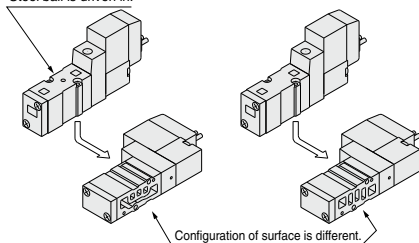

Combination of Blanking Plate Assembly and Manifold Base

Blanking plate assembly SYJ3000-21-12A(-Q)

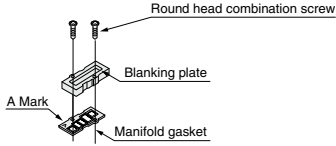

Applicable manifold base

Type SS5YJ3-20(-Q)
 Type SS5YJ3-21SA(-Q)
 Type SS5YJ3-41(-Q)
 Type SS5YJ3-S41(-Q)
 Type SS5YJ3-46(-Q)
 Type SS5YJ3-S46(-Q)
 Type SS5YJ3-S46(-Q)
 Type SS5YJ3-31(-Q)
 Type SS5YJ3-S31(-Q)
 Type SS5YJ3-32(-Q)
 Type SS5YJ3-S32(-Q)
 Type SS5YJ3-32SA(-Q)

Manifold base

Note) Manifold gasket "SYJ3000-14-2" can be used with the following manifold bases.

Manifold base of { Type SS5YJ3-31(-Q)
 -S31(-Q)
 -32(-Q)
 -S32(-Q)
 -32SA(-Q)

Blanking plate assembly SYJ3000-21-13A(-Q)

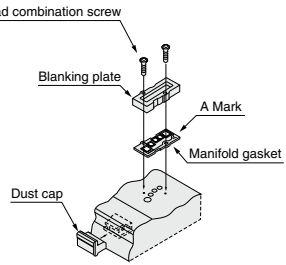

Applicable manifold base

SS5YJ3-21P(-Q)
 SS5YJ3-32P(-Q) } Manifold base

Caution

Mounting screw tightening torques

M1.7: 0.12 N·m

Use caution to the assembly orientation for solenoid valves, gasket, and optional parts.

SJ
SY
SY
SV
SYJ
SZ
VF
VP4
S0700
VQ
VQ4
VQ5
VQC
VQC4
VQZ
SQ
VFS
VFR
VQ7

Series SYJ3000

Type 20 Manifold: Top Ported/SS5YJ3-20- Stations

* []: AC

Grommet (G)

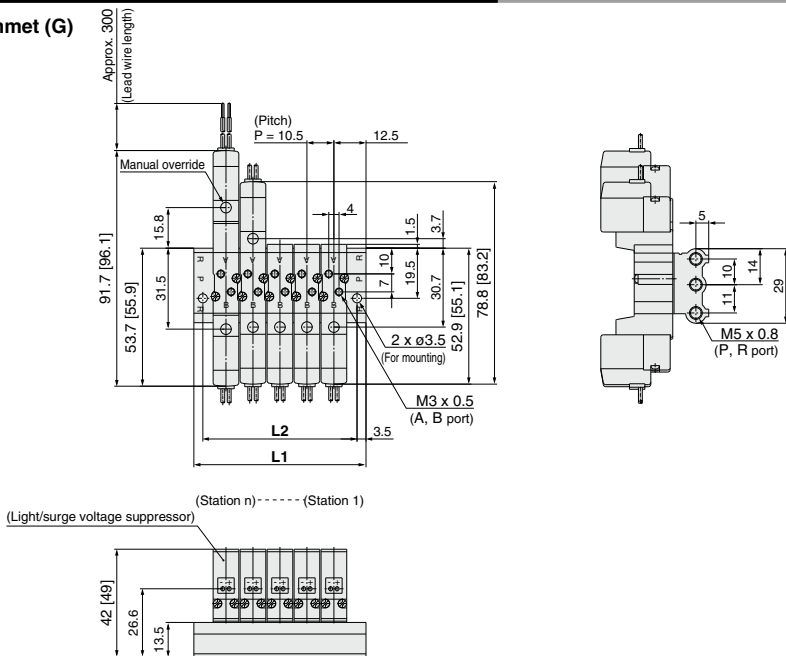

L plug connector (L)

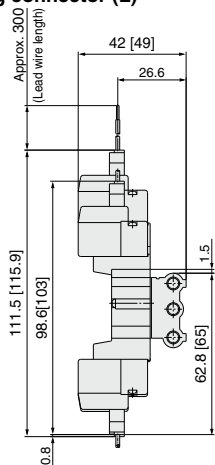

M plug connector (M)

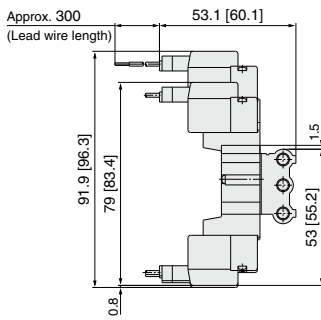

M8 connector (WO)

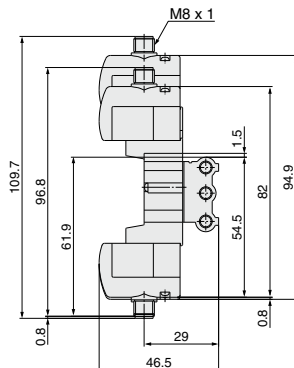

* Refer to page 755 for dimensions with connector cable.

Station n	Station 2	3	4	5	6	7	8	9	10	11	12	13	14	15	16	17	18	19	Station 20
L1	35.5	46	56.5	67	77.5	88	98.5	109	119.5	130	140.5	151	161.5	172	182.5	193	203.5	214	224.5
L2	28.5	39	49.5	60	70.5	81	91.5	102	112.5	123	133.5	144	154.5	165	175.5	186	196.5	207	217.5

Type 31 Manifold: Side Ported/SS5YJ3-1- Stations -M3

* [] : AC

Grommet (G)

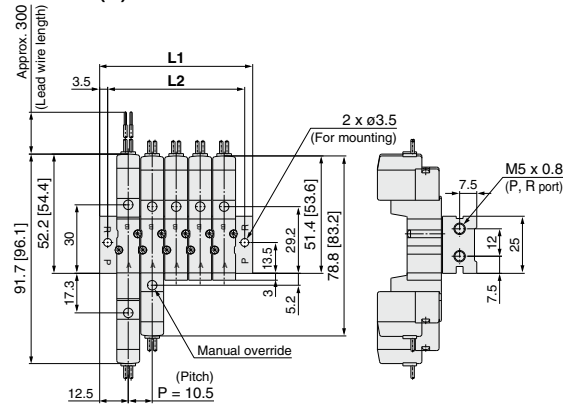

Type S31 Manifold: Side Ported SS5YJ3-S31- Stations -M3

(Single solenoid pilot valve is on same side as the A,B port)

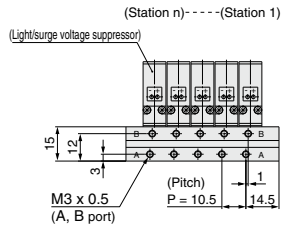
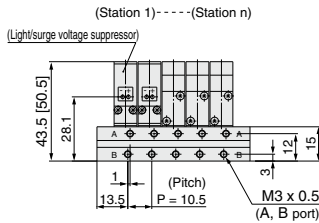
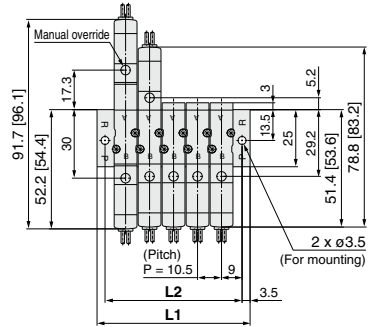

L plug connector (L)

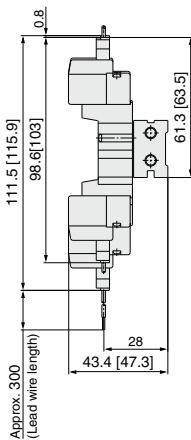

M plug connector (M)

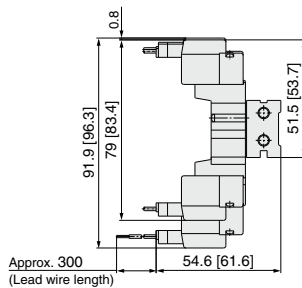

M8 connector (WO)

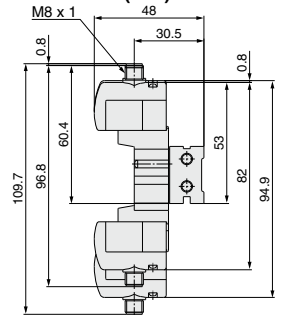

* Refer to page 755 for dimensions with connector cable.

Station n	Station 2	3	4	5	6	7	8	9	10	11	12	13	14	15	16	17	18	19	Station 20
L1	35.5	46	56.5	67	77.5	88	98.5	109	119.5	130	140.5	151	161.5	172	182.5	193	203.5	214	224.5
L2	28.5	39	49.5	60	70.5	81	91.5	102	112.5	123	133.5	144	154.5	165	175.5	186	196.5	207	217.5

SJ
SY
SY
SV
SYJ
SZ
VF
VP4
S0700
VQ
VQ4
VQ5
VQC
VQC4
VQZ
SQ
VFS
VFR
VQ7

Series SYJ3000

Type 32 Manifold: Side Ported/SS5YJ3-32- Stations -M5, C4 N3 □

* [] : AC

Grommet (G) For M5

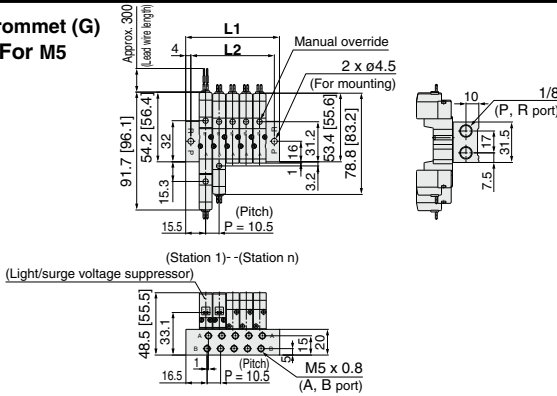

For C4 N3 □ (Built-in One-touch fitting)

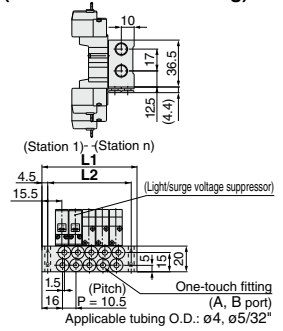

L plug connector (L)

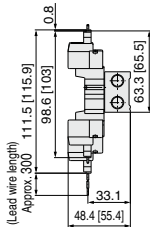

M plug connector (M)

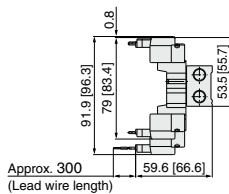

M8 connector (WO)

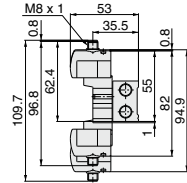

* Refer to page 755 for dimensions with connector cable.

Type S32 Manifold: Side Ported (Single solenoid pilot valve is on same side as the A,B port.) /SS5YJ3-S32- Stations -M5, C4 N3 □

For M5

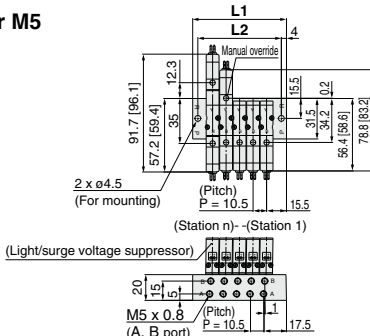

For C4 N3 □ (Built-in One-touch fitting)

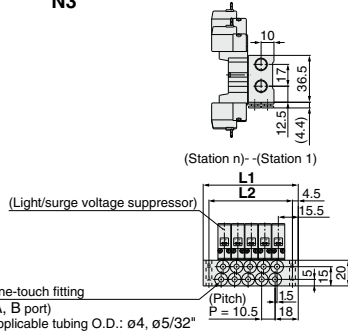

SS5YJ3-32, S32- Stations -M5

Station	Station 2	3	4	5	6	7	8	9	10	11	12	13	14	15	16	17	18	19	Station 20
L1	41.5	52	62.5	73	83.5	94	104.5	115	125.5	136	146.5	157	167.5	178	188.5	199	209.5	220	230.5
L2	33.5	44	54.5	65	75.5	86	96.5	107	117.5	128	138.5	149	159.5	170	180.5	191	201.5	212	222.5

SS5YJ3-32, S32- Stations -C4

Station	Station 2	3	4	5	6	7	8	9	10	11	12	13	14	15	16	17	18	19	Station 20
L1	42.5	53	63.5	74	84.5	95	105.5	116	126.5	137	147.5	158	168.5	179	189.5	200	210.5	221	231.5
L2	33.5	44	54.5	65	75.5	86	96.5	107	117.5	128	138.5	149	159.5	170	180.5	191	201.5	212	222.5

Type 41 Manifold: Side Ported/SS5YJ3-41- Stations -M5, C4 N3 □

* [] : AC

Grommet (G) For M5

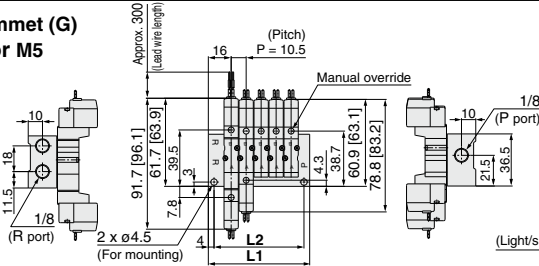

For C4 N3 □ (Built-in One-touch fitting)

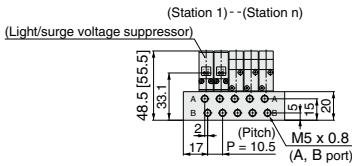
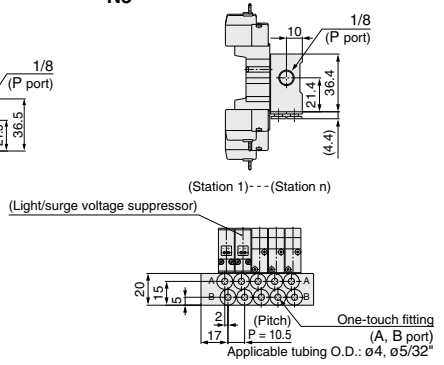

L plug connector (L)

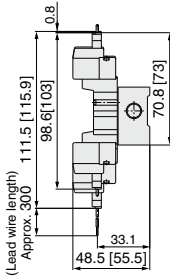

M plug connector (M)

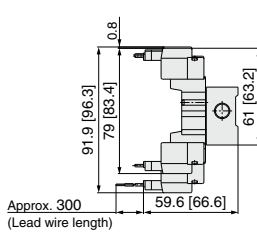

M8 connector (WO)

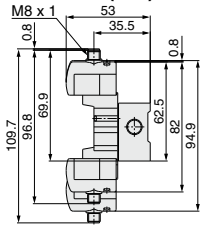

* Refer to page 755 for dimensions with connector cable.

Type S41 Manifold: Side Ported (Single solenoid pilot valve is on same side as the A,B port.) /SS5YJ3-S41- Stations -M5, C4 N3 □

For M5

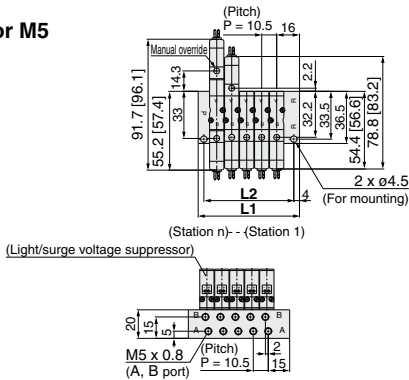

For C4 N3 □ (Built-in One-touch fitting)

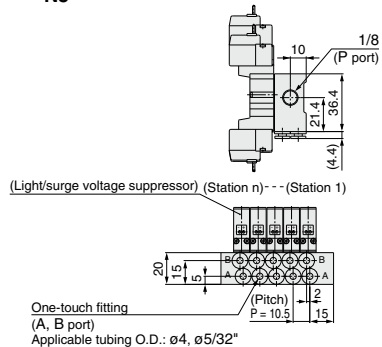

Station n	Station 2	3	4	5	6	7	8	9	10	11	12	13	14	15	16	17	18	19	Station 20
L1	39.5	50	60.5	71	81.5	92	102.5	113	123.5	134	144.5	155	165.5	176	186.5	197	207.5	218	228.5
L2	31.5	42	52.5	63	73.5	84	94.5	105	115.5	126	136.5	147	157.5	168	178.5	189	199.5	210	220.5

- SJ
- SY
- SY
- SV
- SYJ
- SZ
- VF
- VP4
- S0700
- VQ
- VQ4
- VQ5
- VQC
- VQC4
- VQZ
- SQ
- VFS
- VFR
- VQ7

Series SYJ3000

Type 46 Manifold: Side Ported/SS5YJ3-46- Stations -M5, C4 N3

* []: AC

Grommet (G) For M5

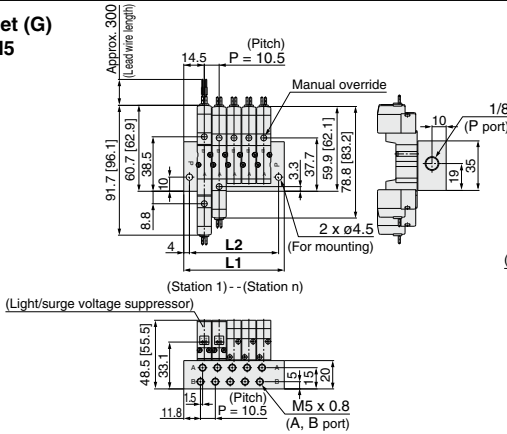

For C4 N3 (Built-in One-touch fitting)

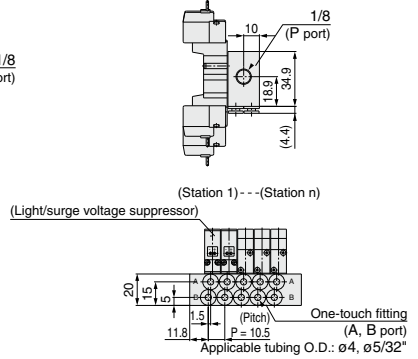

L plug connector (L)

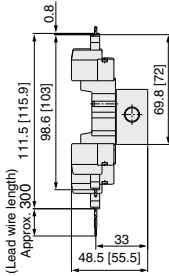

M plug connector (M)

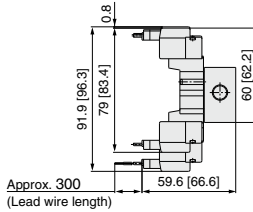

M8 connector (WO)

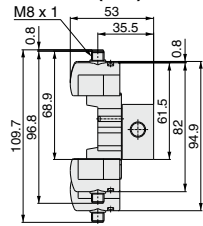

* Refer to page 755 for dimensions with connector cable.

Type S46 Manifold: Side Ported (Single solenoid pilot valve is on same side as the A,B port.) /SS5YJ3-S46- Stations -M5, C4 N3

For M5

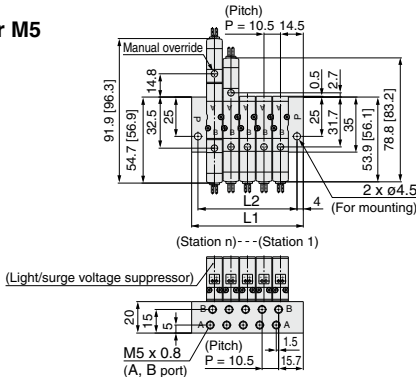

For C4 N3 (Built-in One-touch fitting)

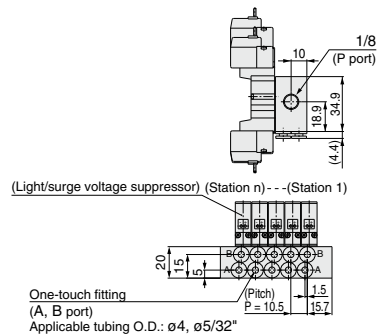

Station n	Station 2	3	4	5	6	7	8	9	10	11	12	13	14	15	16	17	18	19	Station 20
L1	39.5	50	60.5	71	81.5	92	102.5	113	123.5	134	144.5	155	165.5	176	186.5	197	207.5	218	228.5
L2	31.5	42	52.5	63	73.5	84	94.5	105	115.5	126	136.5	147	157.5	168	178.5	189	199.5	210	220.5

Flat Ribbon Cable Manifold

* []: AC

SS5YJ3-21P-**Stations**-00□

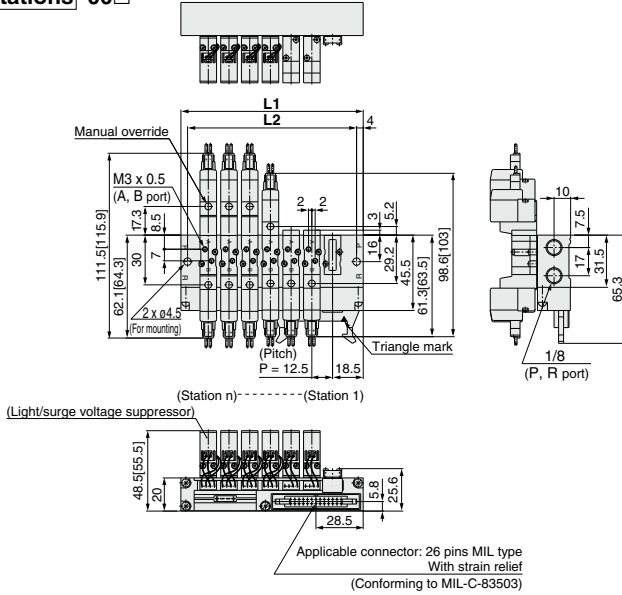

- SJ
- SY
- SY
- SV
- SYJ**
- SZ
- VF
- VP4
- S0700
- VQ
- VQ4
- VQ5
- VQC
- VQC4
- VQZ
- SQ
- VFS
- VFR
- VQ7

SS5YJ3-32P-**Stations**-M5, C4 N3□ For M5

For C4 N3□ (Built-in One-touch fitting)

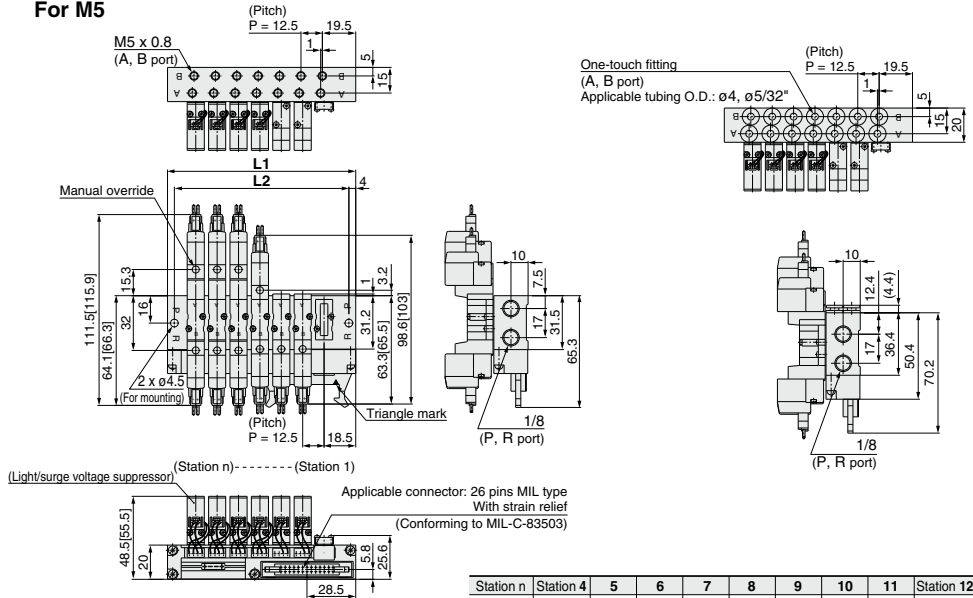

Station n	Station 4	5	6	7	8	9	10	11	Station 12
L1	72.5	85	97.5	110	122.5	135	147.5	160	172.5
L2	64.5	77	89.5	102	114.5	127	139.5	152	164.5

Series SYJ3000

EX510 Gateway-type Serial Transmission System

SYJ3000:SS5YJ3-21SA □ - Stations □ - □

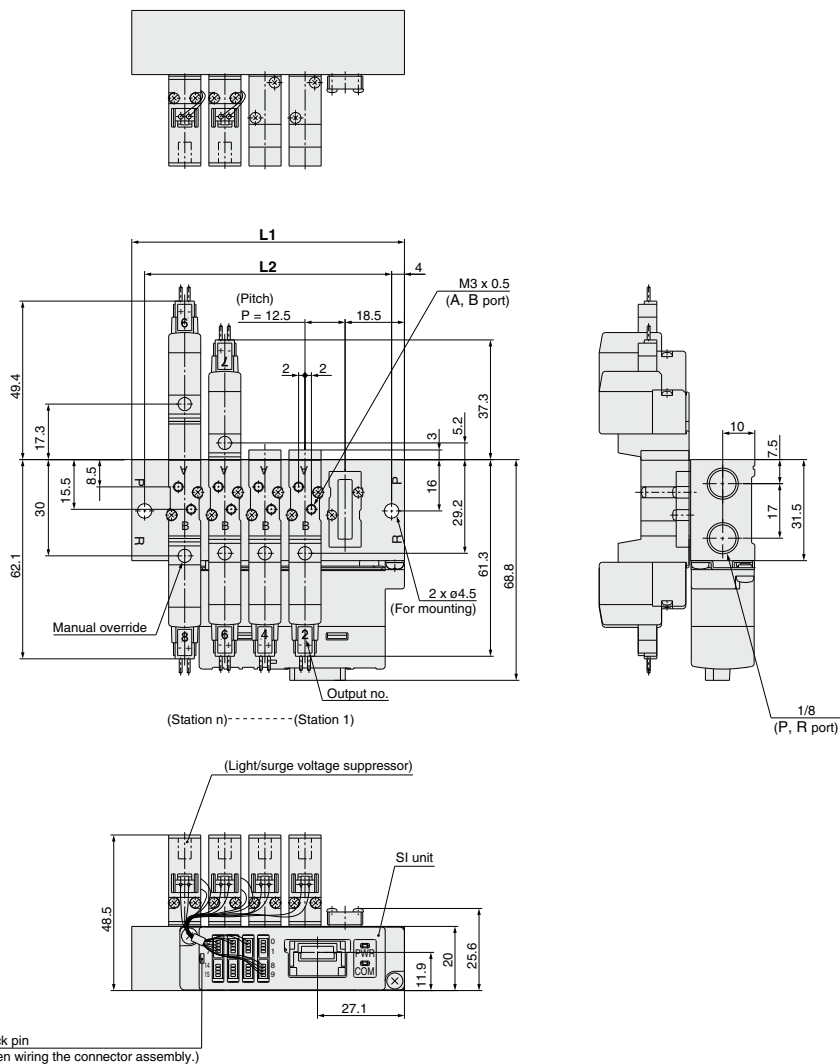

Station n	Station 4	5	6	7	8	9	10	11	12	13	14	15	Station 16
L1	72.5	85	97.5	110	122.5	135	147.5	160	172.5	185	197.5	210	222.5
L2	64.5	77	89.5	102	114.5	127	139.5	152	164.5	177	189.5	202	214.5

EX510 Gateway-type Serial Transmission System

SYJ3000:SS5YJ3-32SA□-Stations-M5,C4□ For C4 N3□ (Built-in One-touch fitting)

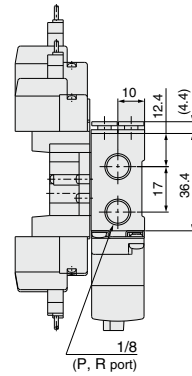
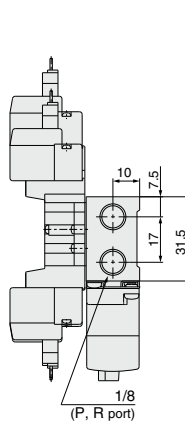
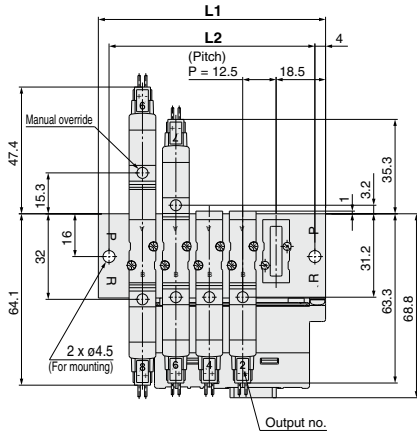
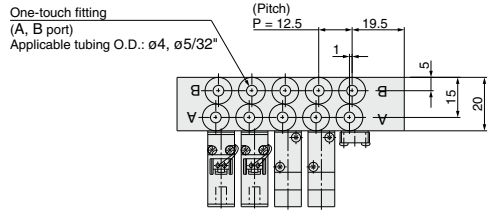
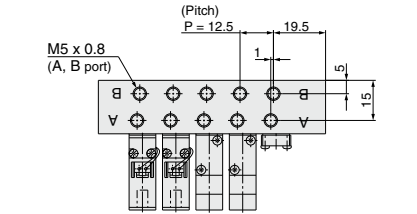

(Station n)----- (Station 1)

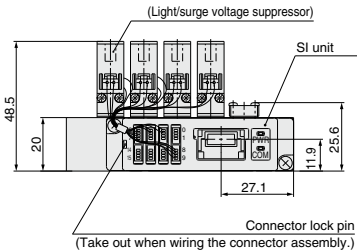

SJ
SY
SY
SV
SYJ
SZ
VF
VP4
S0700
VQ
VQ4
VQ5
VQC
VQC4
VQZ
SQ
VFS
VFR
VQ7

Station n	Station 4	5	6	7	8	9	10	11	12	13	14	15	Station 16
L1	72.5	85	97.5	110	122.5	135	147.5	160	172.5	185	197.5	210	222.5
L2	64.5	77	89.5	102	114.5	127	139.5	152	164.5	177	189.5	202	214.5

Rubber Seal 5 Port Solenoid Valve

Series SYJ5000



Specifications

Fluid		Air
Operating pressure range (MPa)	2 position single	0.15 to 0.7
	2 position double	0.1 to 0.7
	3 position	0.15 to 0.7
Ambient and fluid temperature (°C)		-10 to 50 (No freezing.)
Response time (ms) (Note 1) (at 0.5 MPa)	2 position single, double	25 or less
	3 position	40 or less
Max. operating frequency (Hz)	2 position single, double	5
	3 position	3
Manual override (Manual operation)	Non-locking push type, Push-turn locking slotted type, Push-turn locking lever type	
Pilot exhaust method	Individual exhaust for the pilot valve, Common exhaust for the pilot and main valve	
Lubrication	Not required	
Mounting orientation	Unrestricted	
Impact/Vibration resistance (m/s²) (Note 2)	150/30	
Enclosure	Dust proof (* DIN terminal, M8 connector conforms to IP65.)	

* Based on IEC60529

Note 1) Based on dynamic performance test, JIS B 8375-1981. (Coil temperature: 20°C, at rated voltage, without surge voltage suppressor)

Note 2) Impact resistance: No malfunction occurred when it is tested in the axial direction and at the right angles to the main valve and armature in both energized and de-energized states every once for each condition. (Value in the initial state)
Vibration resistance: No malfunction occurred in one sweep test between 45 and 2000 Hz. Test was performed at both energized and de-energized states in the axial direction and at the right angles to the main valve and armature. (Value in the initial state)

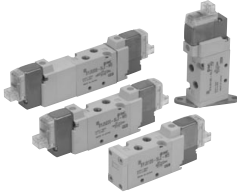

Body ported

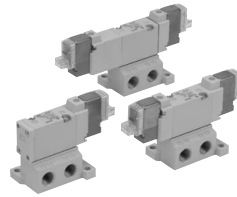

Base mounted

Symbol

Body ported

2 position single

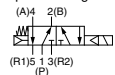

2 position double

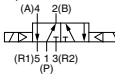

3 position closed center

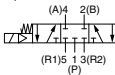

3 position exhaust center

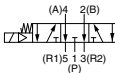

3 position pressure center

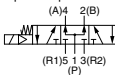

Base mounted (with sub-plate)

2 position single

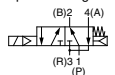

2 position double

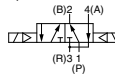

3 position closed center

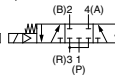

3 position exhaust center

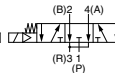

3 position pressure center

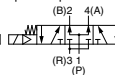

Solenoid Specifications

Electrical entry	Grommet (G), (H), L plug connector (L) M plug connector: (M), DIN terminal (D, Y) M8 connector (W)	
	G, H, L, M, W	D, Y
Coil rated voltage (V)	DC AC 50/60 Hz	24, 12, 6, 5, 3 100, 110, 200, 220
Allowable voltage fluctuation	±10% of rated voltage *	
Power consumption (W)	DC	0.35 (With light: 0.4 (DIN terminal with light: 0.45)) 0.1 (With light only) * [Starting 0.4, Holding 0.1]
	AC	100 V 0.78 (With light: 0.81) 0.78 (With light: 0.87) 110 V 0.86 (With light: 0.89) 0.86 (With light: 0.97) [115 V] [0.94 (With light: 0.97)] [0.94 (With light: 1.07)] 200 V 1.18 (With light: 1.22) 1.15 (With light: 1.30) 220 V 1.30 (With light: 1.34) 1.27 (With light: 1.46) [230 V] [1.42 (With light: 1.46)] [1.39 (With light: 1.60)]
Apparent power (VA) *		
Surge voltage suppressor	Diode (DIN terminal, Varistor when non-polar types)	
Indicator light	LED (Neon light when AC with DIN terminal)	

* In common between 110 VAC and 115 VAC, and between 220 VAC and 230 VAC.

* For 115 VAC and 230 VAC, the allowable voltage is -15% to +5% of rated voltage.

* For details refer to page 752.

Built-in Speed Controller

SYJ5□5□

- Built-in exhaust flow controls enable simple cylinder speed adjustments.
- When mounted on the manifold, the common exhaust discharges the pilot and main valve exhaust through a common EXH port to enable simple exhausting.

Symbol

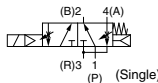

How to order valve with built-in speed controller

SYJ5□5□-□□□□□□□□□□

- Type of actuation
- Body Option
- Rated voltage
- Light/surge voltage suppressor
- CE-compliant
- Port size
- Manual override

Throttle Valve Characteristics (A_B → R)

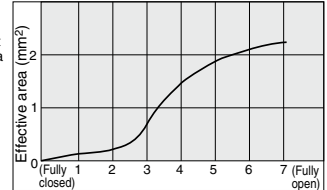

- When using SYJ5□53 model the speed controller must be opened more than 1 complete rotation from fully closed in order to function properly.
- Adjust the speed controller with a torque of 0.3 N·m or less.

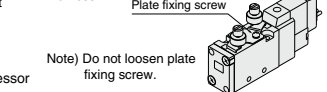

Made to Order

(For details, refer to pages 748 and 749.)

Flow Characteristics/Weight

Valve model	Type of actuation	Port size		Flow characteristics <small>(Note 1)</small>						Weight (g) <small>(Note 2, 3)</small>					
		1, 5, 3 (P, EA, EB)	4, 2 (A, B)	1R4/2 (PRA/B)			4/2R5/3 (A/BREA/EB)			Grommet	L/M plug connector	DIN terminal	M8 connector		
		C [dm ³ /(s·bar)]	b	Cv	C [dm ³ /(s·bar)]	b	Cv								
Body ported	SYJ5□20-□-M5	2 position	Single	M5 x 0.8	M5 x 0.8	0.47	0.41	0.13	0.47	0.41	0.13	46	47	68	51
			Double			0.49	0.44	0.13	0.44	0.40	0.12	64	66	108	74
		3 position	Closed center			0.46	0.37	0.12	0.47 [0.39]	0.43 [0.35]	0.13 [0.10]	75	77	119	85
			Exhaust center Pressure center			0.49 [0.39]	0.51 [0.38]	0.14 [0.10]	0.45	0.42	0.12				
	SYJ5□20-□-C4	2 position	Single	M5 x 0.8	C4 (One-touch fitting for ø4)	0.69	0.39	0.18	0.44	0.39	0.12	53	54	75	58
			Double			0.69	0.40	0.19	0.43	0.40	0.12	71	73	115	81
		3 position	Closed center			0.56	0.40	0.15	0.41 [0.41]	0.37 [0.37]	0.10 [0.11]	82	84	126	72
			Exhaust center Pressure center			0.57 [0.41]	0.4 [0.37]	0.15 [0.10]	0.41	0.37	0.10				
	SYJ5□20-□-C6	2 position	Single	M5 x 0.8	C6 (One-touch fitting for ø6)	0.70	0.36	0.19	0.47	0.40	0.12	53	54	75	58
			Double			0.72	0.37	0.19	0.44	0.34	0.12	71	73	115	81
		3 position	Closed center			0.67	0.54	0.19	0.41 [0.41]	0.38 [0.38]	0.11 [0.11]	82	84	126	92
			Exhaust center Pressure center			0.82 [0.44]	0.41 [0.39]	0.23 [0.12]	0.41	0.36	0.11				
Base mounted	SYJ5□40-□-01	2 position	Single	1/8	1/8	0.79	0.21	0.19	0.83	0.32	0.21	80 (49)	81 (47)	102 (68)	51
			Double			0.80	0.28	0.18	0.86	0.34	0.20	98 (64)	100 (66)	142 (108)	74
		3 position	Closed center			0.71	0.26	0.18	1.1 [0.60]	0.24 [0.44]	0.26 [0.18]	109 (75)	111 (77)	153 (119)	85
			Exhaust center			0.99 [0.47]	0.29 [0.38]	0.24 [0.12]	0.72	0.38	0.18				
			Pressure center												

Note 1) []: denotes the normal position. Exhaust center: 4/2 → 5/3, Pressure center: 1 → 4/2

Note 2) (): Without sub-plate.

Note 3) For DC voltages. For AC voltages add 3 g to the weight of the single solenoid and 6 g to the weight of the double solenoid and 3 position types.

Cylinder Speed Chart

Use as a guide for selection.
Please confirm the actual conditions with SMC
Sizing Program.

Body Ported

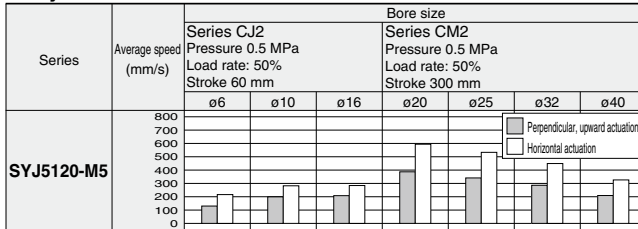

Base Mounted

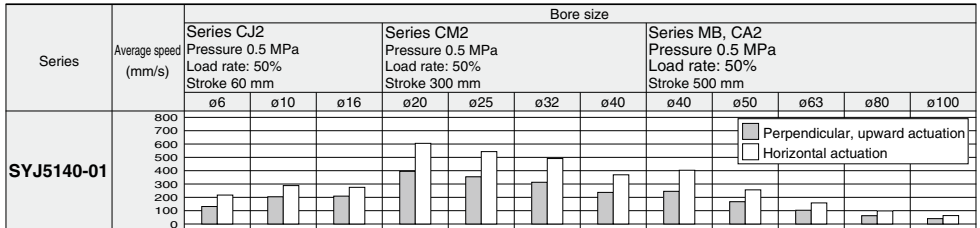

* Cylinder is in extending. Speed controller is meter-out, which is directly connected with cylinder and its needle is fully opened.

* Average speed of cylinder is obtained by dividing the full stroke time by the stroke.

* Load factor: (Load weight x 9.8) / Theoretical force x 100%

Conditions

	Body ported	Series CJ2	Series CM2	Series MB/CA2
SYJ5120-M5	Tubing bore x Length	ø4 x 1 m	ø6 x 1 m	ø8 x 1 m
	Speed controller	AS1301F-04	AS3301F-06	AS3301F-08
	Silencer	AN120-M5	AN110-01	

	Base mounted	Series CJ2	Series CM2	Series MB/CA2
SYJ5140-01	Tubing bore x Length	ø4 x 1 m	ø6 x 1 m	
	Speed controller	AS2301F-04	AS3001F-06	
	Silencer	AN101-01	AN101-01	

SJ
SY
SY
SV
SYJ
SZ
VF
VP4
S0700
VQ
VQ4
VQ5
VQC
VQC4
VQZ
SQ
VFS
VFR
VQ7

How to Order

Note) AC-type models that are CE-compliant have DIN terminals only.

[Option]

Type of actuation

1	2 position single solenoid
2	2 position double solenoid
3	3 position closed center
4	3 position exhaust center
5	3 position pressure center

Light/Surge voltage suppressor

Electrical entry for G, H, L, M, W

Nil	Without light/surge voltage suppressor
S	With surge voltage suppressor
Z	With light/surge voltage suppressor
R	With surge voltage suppressor (Non-polar type)
U	With light/surge voltage suppressor (Non-polar type)

- * For AC voltage valves there is no "S" option. It is already built-in to the rectifier circuit.
- * For type "R" and "U", DC voltage is only available.
- * Power saving circuit is only available in the "Z" type.

Electrical entry for D, Y

Nil	Without light/surge voltage suppressor
S	With surge voltage suppressor (Non-polar type)
Z	With light/surge voltage suppressor (Non-polar type)

- * DOZ and YOZ are not available.
- * For AC voltage valves there is no "S" option. It is already built-in to the rectifier circuit.

Rated voltage

DC	AC (50/60 Hz)
5	1 100 VAC
6	2 200 VAC
V	3 110 VAC [115 VAC]
S	4 220 VAC [230 VAC]
R	3 VDC

- * DC specifications of type D, Y, DO and YO are only available with 12 and 24 VDC.
- * For type W□, DC voltage is only available.
- Note) AC-type models that are CE-compliant have DIN terminals only.

A, B port size

M5	M5 x 0.8
C4	One-touch fitting for $\phi 4$
C6	One-touch fitting for $\phi 6$
N3	One-touch fitting for $\phi 5/32$ "
N7	One-touch fitting for $\phi 1/4$ "

Bracket

Nil: Without bracket
F: With bracket

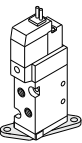

Note) The mounting bracket is supplied unattached.
* 2 position single type only.

Made to Order

Nil	—
X20	Body Ported External Pilot (Refer to page 748.)

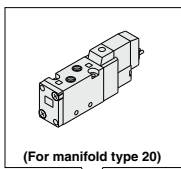

Body ported

SYJ5 1 2 0 □ - 5 L □ □ □ - M5 - □ - □ - □ - □ - □

Base mounted

SYJ5 2 4 0 □ - 5 L □ □ □ - □ - □ - □ - □ - □

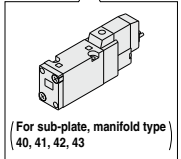

Body option

- 0: Pilot valve individual exhaust for the pilot valve
- 3: Common exhaust type for main and pilot valve

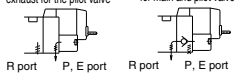

Coil specifications

Nil	Standard
T	With power saving circuit <24, 12 VDC only>

- * Power saving circuit is not available in the case of D, Y, DO, YO or W□ type.

Thread type

Nil	Rc
F	G
N	NPT
T	NPTF

CE-compliant

Nil	—
Q	CE-compliant

Note) AC-type models that are CE-compliant have DIN terminals only.

Manual override

Nil: Non-locking push type

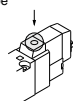

D: Push-turn locking slotted type

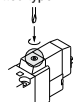

E: Push-turn locking lever type

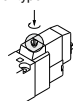

Note) When placing an order for body ported solenoid valve as a single unit, mounting screws for manifold and gasket are not attached. Order them separately, if necessary. (For details, refer to page 706.)

Electrical entry

24, 12, 6, 5, 3 VDC 100, 110, 200, 220 VAC				24, 12 VDC 100, 110, 200, 220 VAC		24, 12, 6, 5, 3 VDC	
Grommet		M plug connector		DIN terminal		M8 connector	
G: Lead wire length 300 mm	L: With lead wire (Length 300 mm)	M: With lead wire (Length 300 mm)	MN: Without lead wire	D, Y: With connector	WO: Without connector cable		
H: Lead wire length 600 mm	LN: Without lead wire	LO: Without connector	MO: Without connector	DO, YO: Without connector	W□: With connector cable (Note 1)		
CE-compliant	DC	AC					

- * LN, MN type: with 2 sockets.
- * Refer to page 751 for the lead wire length of L and M plug connectors.
- * Refer to page 754 for the connector assembly with cover for L and M plug connectors.
- * DIN terminal type "Y" which conforms to EN-175301-803C (former DIN4365C) is also available. For details, refer to page 753.
- * For connector cable of M8 connector, refer to page 754.
- * M8 thread conforming to IEC60947-5-2 standard is also available. Refer to page 749 for details.

Note 1) Enter the cable length symbols in □. Please be sure to fill in the blank referring to page 754.

Construction

2 position single

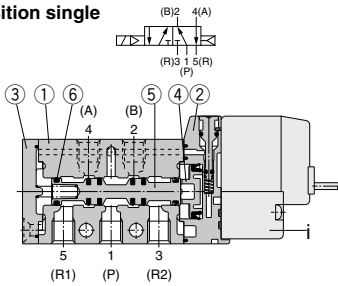

2 position double

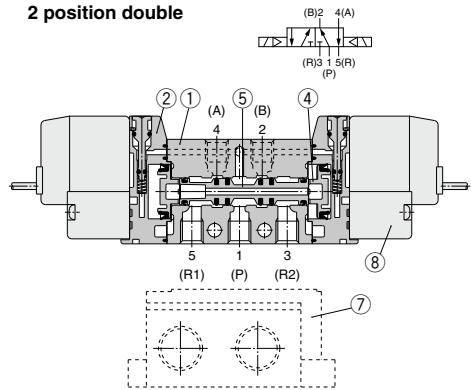

3 position closed center/exhaust center/pressure center

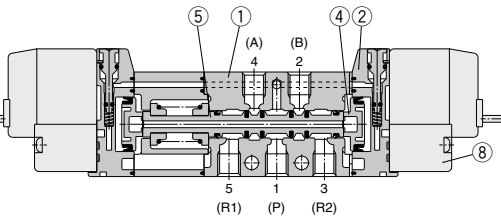
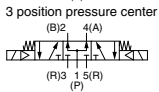
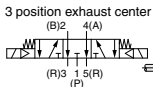
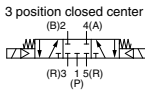

(This figure shows a closed center type.)

Component Parts

No.	Description	Material	Note
1	Body	Aluminum die-casted	White
2	Piston plate	Resin	White
3	End cover	Resin	White
4	Piston	Resin	—
5	Spool valve assembly	Aluminum, H-NBR	—
6	Spool spring	Stainless steel	—

Replacement Parts

No.	Description	Part no.	Note
7	Sub-plate ^(Note)	SYJ5000-22-1 (-Q)	Aluminum die-casted
8	Pilot valve	V111(T)-□□□	—
—	Bracket assembly	SYJ5000-13-3A	—

* Add suffix "-Q" for the CE-compliant product.

SJ
SY
SY
SV
SYJ
SZ
VF
VP4
S0700
VQ
VQ4
VQ5
VQC
VQC4
VQZ
SQ
VFS
VFR
VQ7

Series SYJ5000

How to Order Pilot Valve Assembly

V111 - 5 G

• Coil specifications

NII	Standard
T	With power saving circuit (24, 12 VDC only)

* Power saving circuit is not available in the case of W type.

• Rated voltage

5	24 VDC
6	12 VDC
V	6 VDC
S	5 VDC
R	3 VDC
1	100 VAC 50/60 Hz
2	200 VAC 50/60 Hz
3	110 VAC 50/60 Hz [115 VAC 50/60 Hz]
4	220 VAC 50/60 Hz [230 VAC 50/60 Hz]

* For type W , DC voltage is only available.

* CE-compliant: For DC only.

• Light/Surge voltage suppressor

NII	Without light/surge voltage suppressor
S	With surge voltage suppressor
Z	With light/surge voltage suppressor
R	With surge voltage suppressor (Non-polar type)
U	With light/surge voltage suppressor (Non-polar type)

* For AC voltage valves there is no "S" option. It is already built-in to the rectifier circuit.

* For type "R" and "U", DC voltage is only available.

* Power saving circuit is only available in the "Z" type.

• Electrical entry

G	Grommet, 300 mm lead wire
H	Grommet, 600 mm lead wire
L	With lead wire
LN	L plug Without lead wire
LO	connector Without connector
M	With lead wire
MN	M plug Without lead wire
MO	connector Without connector
WO	M8 Without connector cable
W <input type="checkbox"/>	connector With connector cable ^{Note 1)}

* For connector cable of M8 connector, refer to page 754.

Note 1) Enter the cable length symbols in . Please be sure to fill in the blank referring to page 754.

V115 - 5 D

• Rated voltage

5	24 VDC
6	12 VDC
1	100 VAC 50/60 Hz
2	200 VAC 50/60 Hz
3	110 VAC 50/60 Hz [115 VAC 50/60 Hz]
4	220 VAC 50/60 Hz [230 VAC 50/60 Hz]

* DC specifications of type D and DO is only available with 12 and 24 VDC.

* Power saving circuit is not available in the case of D or DO type.

• Light/Surge voltage suppressor

NII	Without light/surge voltage suppressor
S	With surge voltage suppressor (Non-polar type)
Z	With light/surge voltage suppressor (Non-polar type)

* DOZ and YOZ are not available.

* For AC voltage valves there is no "S" option. It is already built-in to the rectifier circuit.

• Electrical entry

D	DIN terminal	With connector
DO	(Type D)	Without connector
Y	DIN terminal	With connector
DO	(Type Y)	Without connector

Note) Do not replace V111 (G, H, L, M, W) to V115 (DIN terminal) and vice versa when replacing pilot valve assembly only.

Note) Since V111 and V115 are CE-compliant as standard, the suffix "-Q" is not necessary.

2 Position Single

* [] : AC

Grommet (G), (H): SYJ5120-□_G□□-M5

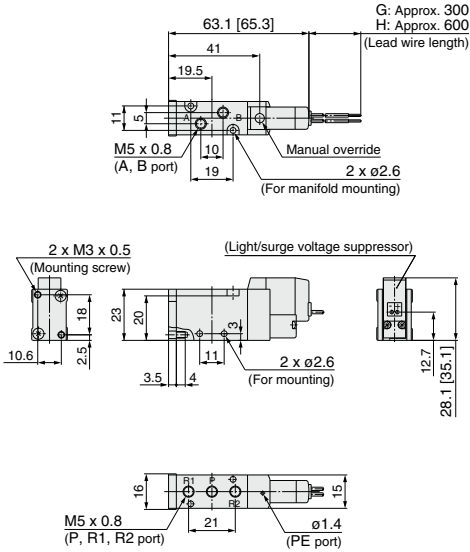

**With bracket
SYJ5120-□_G□□-M5-F**

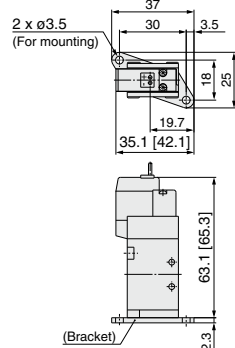

**Built-in One-touch fitting:
SYJ5120-□_G□□-C₄N₃C₆N₇(-F)**

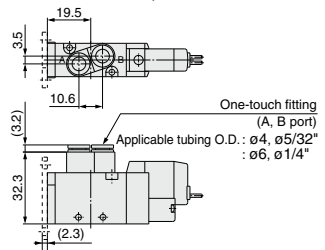

**L plug connector (L):
SYJ5120-□L□□-M5(-F)**

**M plug connector (M):
SYJ5120-□M□□-M5(-F)**

**DIN terminal (D, Y):
SYJ5120-□□□□-M5(-F)**

**M8 connector (WO):
SYJ5120-□WO□□-M5(-F)**

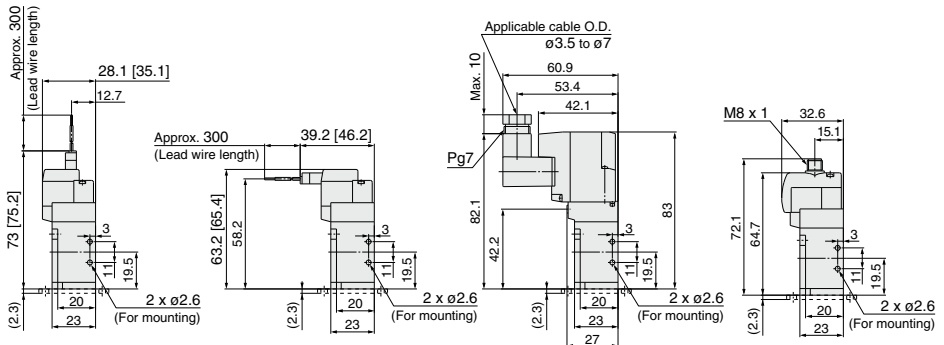

* Refer to page 755 for dimensions with connector cable.

SJ
SY
SY
SV
SYJ
SZ
VF
VP4
S0700
VQ
VQ4
VQ5
VQC
VQC4
VQZ
SQ
VFS
VFR
VQ7

Series SYJ5000

2 Position Double

* []: AC

Grommet (G), (H): SYJ5220-□^G□□-M5

Built-in One-touch fitting:
SYJ5220-□^G□□-^{C4, N3}□□-^{C5, N7}

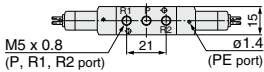
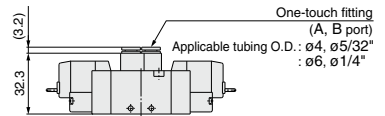
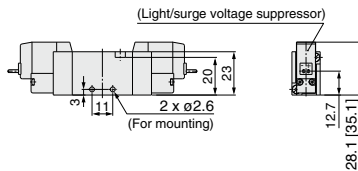
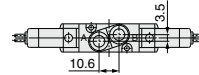
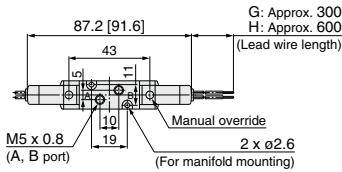

L plug connector (L):
SYJ5220-□L□□-M5

M plug connector (M):
SYJ5220-□M□□-M5

DIN terminal (D, Y):
SYJ5220-□^D□□-M5

M8 connector (WO):
SYJ5220-□WO□□-M5

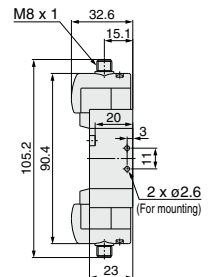
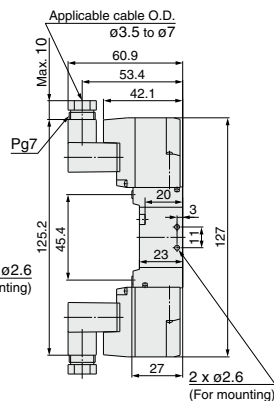
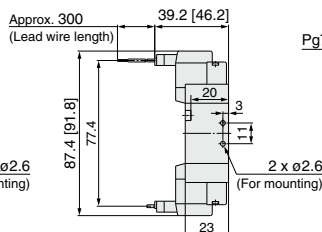
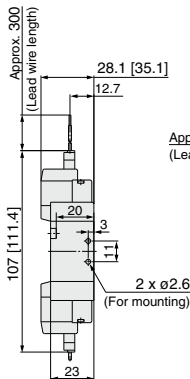

* Refer to page 755 for dimensions with connector cable.

3 Position Closed Center/Exhaust Center/Pressure Center

* []: AC

Grommet (G), (H): SYJ5 $\frac{3}{8}$ 20-□ $\frac{G}{H}$ □□-M5

Built-in one-touch fitting:
SYJ5 $\frac{3}{8}$ 20-□ $\frac{G}{H}$ □□-C₄, N₃
C₆, N₇

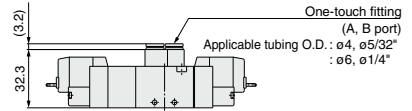
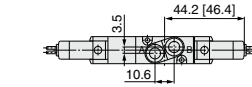
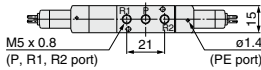
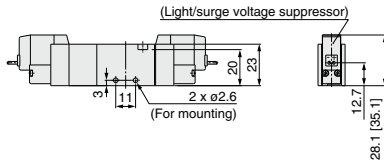
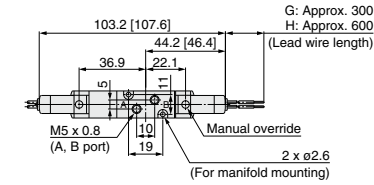

L plug connector (L):
SYJ5 $\frac{3}{8}$ 20-□L□□-M5

M plug connector (M):
SYJ5 $\frac{3}{8}$ 20-□M□□-M5

DIN terminal (D, Y):
SYJ5 $\frac{3}{8}$ 20-□ $\frac{D}{Y}$ □□-M5

M8 connector (WO):
SYJ5 $\frac{3}{8}$ 20-□WO□□-M5

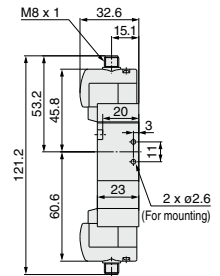
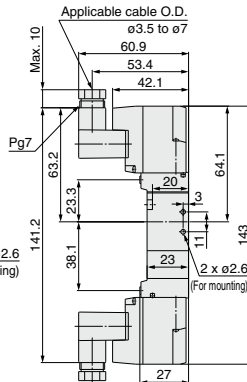
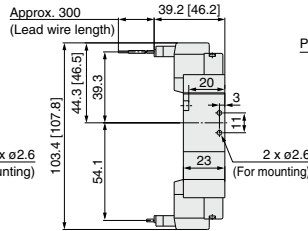
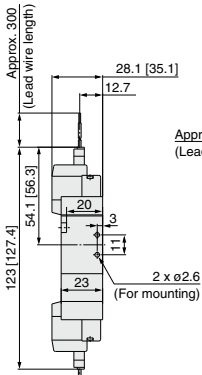

* Refer to page 755 for dimensions with connector cable.

SJ
SY
SY
SV
SYJ
SZ
VF
VP4
S0700
VQ
VQ4
VQ5
VQC
VQC4
VQZ
SQ
VFS
VFR
VQ7

Series SYJ5000

2 Position Single

* []: AC

Grommet (G), (H): SYJ5140-□^G□□-01□

Built-in speed controller:
SYJ5150-□^G□□-01□

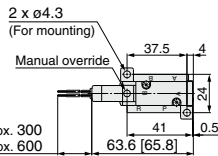
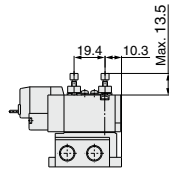
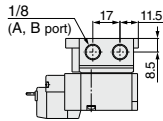

With interface regulator

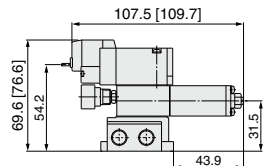

(Light/surge voltage suppressor)

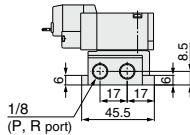
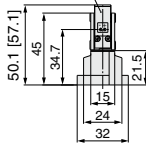

L plug connector (L):
SYJ5140-□L□□-01□

M plug connector (M):
SYJ5140-□M□□-01□

DIN terminal (D, Y):
SYJ5140-□^D□□-01□

M8 connector (WO):
SYJ5140-□WO□□-01□

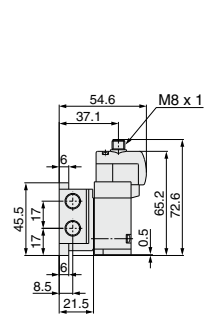
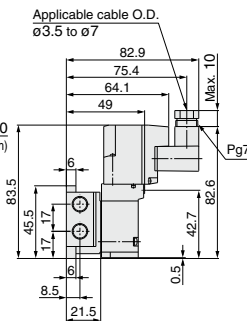
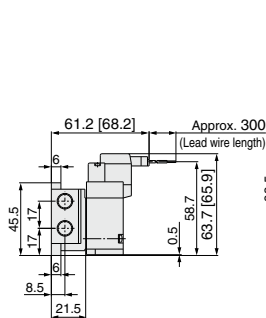
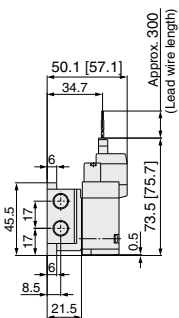

* Refer to page 755 for dimentionts with connector cable.

2 Position Double

* [] : AC

Grommet (G), (H): SYJ5240-□_H□□-01□

Built-in speed controller:
SYJ5250-□_H□□-01□

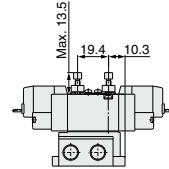
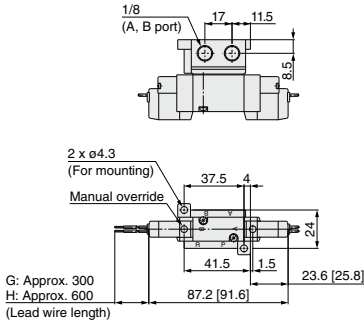

With interface regulator

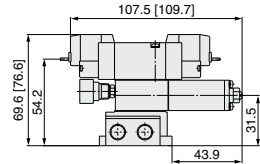

(Light/surge voltage suppressor)

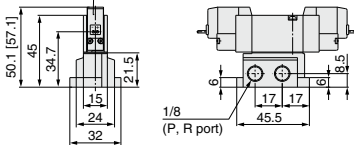

L plug connector (L):
SYJ5240-□L□□-01□

M plug connector (M):
SYJ5240-□M□□-01□

DIN terminal (D, Y):
SYJ5240-□_D□□-01□

M8 connector (WO):
SYJ5240-□WO□□-01□

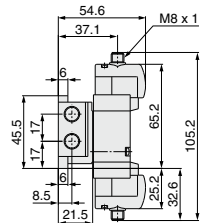
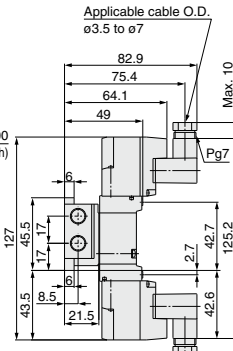
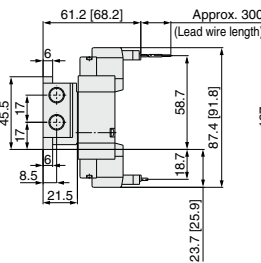
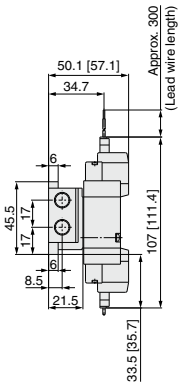

* Refer to page 755 for dimensions with connector cable.

- SJ
- SY
- SY
- SV
- SYJ**
- SZ
- VF
- VP4
- S0700
- VQ
- VQ4
- VQ5
- VQC
- VQC4
- VQZ
- SQ
- VFS
- VFR
- VQ7

Series SYJ5000

3 Position Closed Center/Exhaust Center/Pressure Center

* [] : AC

Grommet (G), (H): SYJ5₅³/₄□□□□-01□

Built-in speed controller:
SYJ5₅³/₄50□□□□-01□

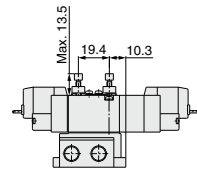
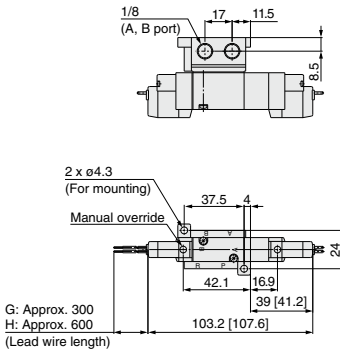

With interface regulator

(Light/surge voltage suppressor)

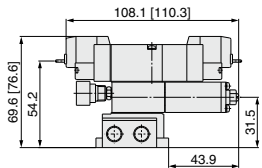
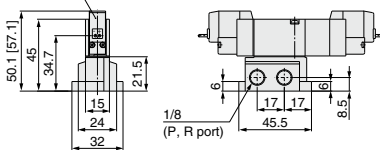

L plug connector (L):
SYJ5₅³/₄40□□□□-01□

M plug connector (M):
SYJ5₅³/₄40□□M□□□-01□

DIN terminal (D, Y):
SYJ5₅³/₄40□□□□-01□

M8 connector (WO):
SYJ5₅³/₄40□□WO□□□-01□

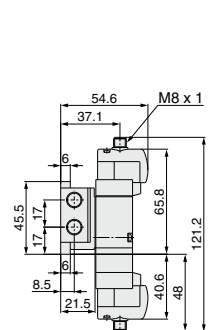
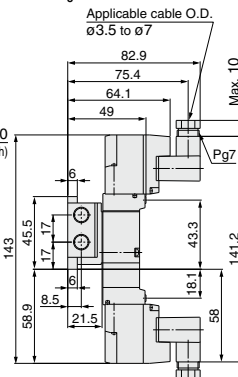
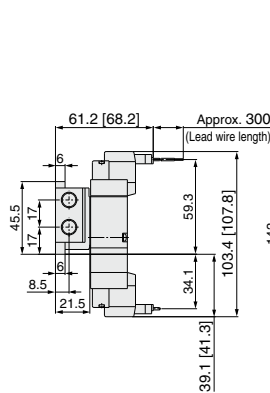
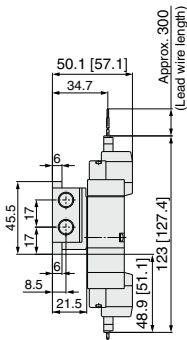

* Refer to page 755 for dimensions with connector cable.

Manifold Standard

Manifold Specifications



Model		Type 20	Type 40	Type 41	Type 42	Type 43
Manifold type		Single base/B mount				
P (SUP), R (EXH)		Common SUP, Common EXH				
Valve stations		2 to 20 stations				
A, B port Porting specifications	Location	Valve	Base	Base		
	Direction	Top		Side		
Port size	P, R port	1/8			1/4	1/8
	A, B port	M5 x 0.8, C4 (One-touch fitting for ø4) C6 (One-touch fitting for ø6)	M5 x 0.8		1/8, C6 (One-touch fitting for ø6)	C4 (One-touch fitting for ø4)

Flow Characteristics

Manifold			Port size		Flow characteristics					
					1→4/2 (P→A/B)			4/2→5/3 (A/B→R)		
					C [dm ³ /(s·bar)]	b	Cv	C [dm ³ /(s·bar)]	b	Cv
Body ported for internal pilot	Type SSSYJ5-20	SYJ5□2□	1(P), 5/3(R)	2(B), 4(A)	C	b	Cv	C	b	Cv
			Port	Port	[dm ³ /(s·bar)]			[dm ³ /(s·bar)]		
			1/8	M5 x 0.8	0.46	0.39	0.12	0.75	0.32	0.19
Base mounted for internal pilot	Type SSSYJ5-40 Type SSSYJ5-41 Type SSSYJ5-42-01 Type SSSYJ5-42-C6 Type SSSYJ5-43	SYJ5□4□	1/8	C4	0.62	0.33	0.16	0.83	0.27	0.20
			1/8	C6	0.79	0.36	0.21	0.91	0.36	0.24
			1/8	M5 x 0.8	0.55	0.35	0.15	0.64	0.26	0.16
			1/8	M5 x 0.8	0.59	0.35	0.16	0.68	0.23	0.17
			1/4	1/8	0.74	0.22	0.18	0.82	0.31	0.21
			1/4	C6	0.71	0.24	0.17	0.8	0.29	0.20
1/8	C4	0.55	0.29	0.14	0.74	0.32	0.19			

Note) Value at manifold base mounted, 2 position single operating

How to Order Manifold (Example)

Instruct by specifying the valves and blanking plate assembly to be mounted on the manifold along with the manifold base model no.

- Example: **SS5YJ5-20-03** 1 pc. (Manifold base)
 * **SYJ5120-5G-M5** 2 pcs. (Valve)
 * **SYJ5000-21-5A** 1 pc. (Blanking plate assembly)

- SS5YJ5-43-03-C4** 1 pc. (Manifold base)
 * **SYJ5140-5LZ** 1 pc. (Valve)
 * **SYJ5240-5LZ** 1 pc. (Valve)
 * **SYJ5000-21-6A** 1 pc. (Blanking plate assembly)

↳ The asterisk denotes the symbol for assembly. Prefix it to the part nos. of the solenoid valve, etc.

* Use manifold specification sheet.

SJ
SY
SV
SYJ
SZ
VF
VP4
S0700
VQ
VQ4
VQ5
VQC
VQC4
VQZ
SQ
VFS
VFR
VQ7

Flat Ribbon Cable Manifold

Note) CE-compliant:
For DC only.

[Option]

• **Multiple valve wiring is simplified through the use of the flat cable connector.**

• **Clean appearance**

In the case of a flat ribbon cable type, each valve is wired on the print board of manifold base to allow the external wiring to be piped all together with 26 pins MIL connector.

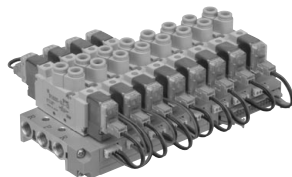

Flat Ribbon Cable Manifold Specifications

Model		Type 20	Type 41P	Type 43P
Manifold type		Single base/B mount		
P (SUP), R (EXH)		Common SUP, Common EXH		
Valve stations		3 to 12 stations		
A, B port	Location	Valve	Base	
	Porting specifications	Direction	Side	
P, R port	P, R port	1/8		1/8
	Port size	M5 x 0.8, C4 (One-touch fitting for ø4) C6 (One-touch fitting for ø6)	M5 x 0.8	C4 (One-touch fitting for ø4)
Applicable flat ribbon cable connector		Socket: 26 pins MIL type with strain relief (MIL-C-83503)		
Internal wiring		In common between +COM and -COM (Z type: +COM only).		
Rated voltage (Note 2)		24, 12 VDC/100, 110 VAC		

Note 1) The withstand voltage specification for the wiring unit section conforms to JIS C 0704, Grade 1 or its equivalent.
Note 2) CE-compliant: For DC only.

Flow Characteristics

Manifold			Port size	Flow characteristics						
				1→4/2 (P→A/B)			4/2→5/3 (A/B→R)			
Body ported for internal pilot	Type SSSYJ5-20P	SYJ5□23	1/8 Port	2(B), 4(A)	C			C		
					[dm³/(s·bar)]	b	Cv	[dm³/(s·bar)]	b	Cv
1/8	C4	SYJ5□43	1/8	M5 x 0.8	0.46	0.39	0.12	0.75	0.32	0.19
					0.62	0.33	0.16	0.83	0.27	0.20
1/8	C6	SYJ5□43	1/8	M5 x 0.8	0.79	0.36	0.21	0.91	0.36	0.24
					0.59	0.35	0.16	0.68	0.23	0.17
1/8	C4	SYJ5□43	1/8	M5 x 0.8	0.55	0.29	0.14	0.74	0.32	0.19
					0.55	0.29	0.14	0.74	0.32	0.19

Note) Value at manifold base mounted, 2 position single operating

How to Order Manifold (Example)

Instruct by specifying the valves and blanking plate assembly to be mounted on the manifold along with the manifold base model no.

Example: **SS5YJ5-41P-07-C4 (-Q) ... 1 pc. (Manifold base)**
 * **SYJ5143-5LOU (-Q) ... 3 pcs. (Valve)**
 * **SYJ5243-5LOU (-Q) ... 3 pcs. (Valve)**
 * **SYJ5000-21-7A ... 1 pc. (Blanking plate assembly)**
 * **SY3000-37-28A ... 3 pcs. (Connector assembly)**
 * **SY3000-37-29A ... 3 pcs. (Connector assembly)**

↳ The asterisk denotes the symbol for assembly. Prefix it to the part nos. of the solenoid valve, etc.

Note) Please indicate the connector assembly part no. below that connects the valve and the manifold.

How to Order Valve

Note) CE-compliant:
For DC only.

[Option]

Rated voltage

5	24 VDC
6	12 VDC

Light/Surge voltage suppressor

Z	With light/surge voltage suppressor
U	With light/surge voltage suppressor (Non-polar type)

Note) Z: Positive common specifications only.
* Power saving circuit is only available in the "Z" type.

CE-compliant

Nil	—
Q	CE-compliant

Note) CE-compliant:
For DC only.

Coil specifications

Nil	Standard
T	With power saving circuit

For DC SYJ5 1 2 3 4 5 LO Z

For AC SYJ5 1 2 3 4 5 LO Z

Type of actuation

1	2 position single
2	2 position double
3	3 position closed center
4	3 position exhaust center
5	3 position pressure center

Rated voltage

1	100 VAC
3	110 VAC (115 VAC)

Manual override

Nil	Non-locking push type
D	Push-turn locking slotted type
E	Push-turn locking lever type

A, B port size

Symbol	Port size
Nil	Base mounted
M5	M5 x 0.8
C4	One-touch fitting for ø4
C6	One-touch fitting for ø6
N3	One-touch fitting for ø5/32"
N7	One-touch fitting for ø1/4"

Note) In the case of flat ribbon cable type, "U" and "Z" types are for DC specifications and "Z" type is for AC specifications. "Z" type for DC is positive common specification only. For the other combination, please contact SMC.

Connector Assembly

20P

For 12, 24 VDC

Single solenoid	SY3000-37-28A
Double solenoid, 3 position type	SY3000-37-29A
Single solenoid	SY3000-37-3A
With individual EXH spacer assembly	
Double solenoid, 3 position type	SY3000-37-4A
With individual EXH spacer assembly	
With 3 port adaptor plate	SY3000-37-3A

For 100 VAC

Single solenoid	SY3000-37-46A
Double solenoid, 3 position type	SY3000-37-47A
Single solenoid	SY3000-37-32A
With individual EXH spacer assembly	
Double solenoid, 3 position type	SY3000-37-33A
With individual EXH spacer assembly	
With 3 port adaptor plate	SY3000-37-32A

For 110 VAC

Single solenoid	SY3000-37-54A
Double solenoid, 3 position type	SY3000-37-55A
Single solenoid	SY3000-37-35A
With individual EXH spacer assembly	
Double solenoid, 3 position type	SY3000-37-36A
With individual EXH spacer assembly	
With 3 port adaptor plate	SY3000-37-35A

EX510 Gateway-type Serial Transmission System

Manifold for EX510 Serial Wiring Specifications

Model		Type 20SA	Type 41SA	Type 42SA	Type 43SA
Manifold type		Single base/B mount			
P (SUP), R (EXH)		Common SUP, Common EXH			
Valve stations		3 to 16 stations			
A, B port	Location	Valve		Base	
	Porting specifications	Top		Side	
Port size	P, R port	1/8			1/4
	A, B port	M5 x 0.8 C4(One-touch fitting for ø4) C6(One-touch fitting for ø6)	M5 x 0.8	1/8	C4 (One-touch fitting for ø4)
Rated voltage		24 VDC			

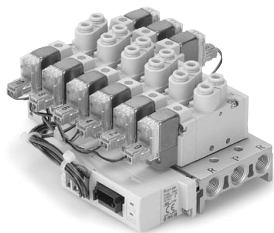

Type 20SA

Flow Characteristics

Manifold			Port size		Flow characteristics					
					1→4/2(P→A/B)			4/2→5/3(A/B→R)		
			1(P), 5/3(R) Port	2(B), 4(A) Port	C (dm ³ /(s·bar))	b	Cv	C (dm ³ /(s·bar))	b	Cv
Body ported for internal pilot	Type SSSYJ5-20SA	SYJ5□2□	1/8	M5 x 0.8	0.46	0.39	0.12	0.75	0.32	0.19
			1/8	C4	0.62	0.33	0.16	0.83	0.27	0.20
Base mounted for internal pilot	Type SSSYJ5-41SA	SYJ5□4□	1/8	M5 x 0.8	0.79	0.36	0.21	0.91	0.36	0.24
			1/8	C4	0.59	0.35	0.16	0.68	0.23	0.17
	Type SSSYJ5-42SA-01	SYJ5□4□	1/4	1/8	0.74	0.22	0.18	0.82	0.31	0.21
			1/8	C4	0.55	0.29	0.14	0.74	0.32	0.19

Note) Value at manifold base mounted, 2 position single operating.

How to Order Manifold (Example)

SSSYJ5-20SA-05 1 set (Type 20SA 5 stations manifold part no.)

* SYJ5123-5LOU-M5 3 sets (Single solenoid part no.)

* SYJ5223-5LOU-M5 2 sets (Double solenoid part no.)

↳ The asterisk denotes the symbol for assembly. Prefix it to the part nos. of the solenoid valve, etc.

Add the valve and option part numbers under the manifold base part number. In the case of complex arrangement, specify them on the manifold specification sheet. The connector assembly lead wire length used for EX510 manifold varies depending on the number of stations. Therefore, solenoid valves (including a blanking plate) and connector assembly are assembled when shipped as a standard specification. Please specify the mounting solenoid valve when ordering.

41P-43P

For 12, 24 VDC

Single solenoid	SY3000-37-28A
Double solenoid, 3 position type	SY3000-37-29A
Single solenoid With individual SUP/EXH spacer assembly	SY3000-37-3A
Double solenoid, 3 position type With individual SUP/EXH spacer assembly	SY3000-37-4A
Single solenoid With interface regulator	SY3000-37-3A
Double solenoid, 3 position type With interface regulator	SY3000-37-6A
With 3 port adaptor plate	SY3000-37-3A

For 100 VAC

Single solenoid	SY3000-37-46A
Double solenoid, 3 position type	SY3000-37-47A
Single solenoid With individual SUP/EXH spacer assembly	SY3000-37-32A
Double solenoid, 3 position type With individual SUP/EXH spacer assembly	SY3000-37-33A
Single solenoid With interface regulator	SY3000-37-15A
Double solenoid, 3 position type With interface regulator	SY3000-37-34A
With 3 port adaptor plate	SY3000-37-32A

For 110 VAC

Single solenoid	SY3000-37-54A
Double solenoid, 3 position type	SY3000-37-55A
Single solenoid With individual SUP/EXH spacer assembly	SY3000-37-35A
Double solenoid, 3 position type With individual SUP/EXH spacer assembly	SY3000-37-36A
Single solenoid With interface regulator	SY3000-37-19A
Double solenoid, 3 position type With interface regulator	SY3000-37-37A
With 3 port adaptor plate	SY3000-37-35A

EX510 Gateway-type Serial Transmission System Body Ported Manifold

Series SYJ5000



How to Order Manifold

SS5YJ5 - 20SA [] - 03 - [] - []

SI unit

Nil	NPN output (+ COM.)
N	PNP output (- COM.)

Valve stations

Symbol	Station	Note
03	3 stations	Double wiring ^{Note 1)}
⋮	⋮	
08	8 stations	
03	3 stations	Specified layout ^{Note 2)} (Up to 16 solenoids)
⋮	⋮	
16	16 stations	

The number of the blanking plate assembly is also included.

Note 1) Double wiring: Use of a single solenoid will result in an unused control signal. If this is not desired, order with a specified layout.

Note 2) Specified layout: Indicate wiring specifications on the manifold specification sheet. (Note that double and 3 position valves cannot be used where single solenoid wiring has been specified.)

CE-compliant

Nil	—
Q	CE-compliant

P, R port thread type

Nil	Rc
00F	G
00N	NPT
00T	NPTF

SI unit part no.

Symbol	SI unit specifications	SI unit part no.	Page
Nil	NPN output (+ COM.)	EX510-S001	P.2143
N	PNP output (- COM.)	EX510-S101	

Refer to page 2124 and the Operation Manual for the details of EX510 Gateway-type Serial Transmission System. Please download the Operation Manual via our website, <http://www.smworld.com>

How to Order Valve

SYJ5 [] 1 23 [] - 5LO [] - M5 - []

Type of actuation

1	2 position single
2	2 position double
3	3 position closed center
4	3 position exhaust center
5	3 position pressure center

Coil specifications

Nil	Standard
T	With power saving circuit

Rated voltage: 24 VDC

Light/Surge voltage suppressor

Z	With light/surge voltage suppressor
U	Without light/surge voltage suppressor (non-polar type)

* Power saving circuit is only available in the "Z" type.

Manual override

Nil	Non-locking push type
D	Push-turn locking slotted type
E	Push-turn locking lever type

A, B port size

M5	M5 x 0.8
C4	One-touch fitting for ø4
C6	One-touch fitting for ø6
N3	One-touch fitting for ø5/32"
N7	One-touch fitting for ø1/4"

CE-compliant

Nil	—
Q	CE-compliant

How to Order Manifold Assembly (Example)

Example

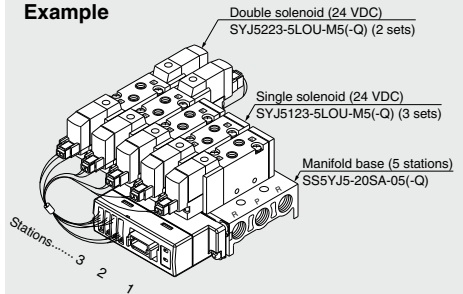

SS5YJ5-20SA-05 (-Q) 1 set (Type 20SA 5-station manifold part no.)
 * SYJ5123-5LOU-M5 (-Q) 3 sets (Single solenoid part no.)
 * SYJ5223-5LOU-M5 (-Q) 2 sets (Double solenoid part no.)

The asterisk denotes the symbol for assembly. Prefix it to the part nos. of the solenoid valve, etc.

Add the valve and option part numbers under the manifold base part number. In the case of complex arrangement, specify them on the manifold specification sheet. The connector assembly lead wire length used for EX510 manifold varies depending on the number of stations. Therefore, solenoid valves (including a blanking plate) and connector assembly are assembled when shipped as a standard specification. Please specify the mounting solenoid valve when ordering.

EX510 Gateway-type Serial Transmission System Base Mounted Manifold

Series SYJ5000



How to Order Manifold

SS5YJ5-41SA - **03** - **M5** - **□** - **□** - **□**
SS5YJ5-42SA - **03** - **01** - **□** - **□** - **□**
SS5YJ5-43SA - **03** - **C4** - **□** - **□** - **□**

SI unit

NII	NPN output (+ COM.)
N	PNP output (- COM.)

Valve stations

Symbol	Station	Note
03	3 stations	Double wiring ^{Note 1)}
⋮	⋮	
08	8 stations	Specified layout ^{Note 2)} (Up to 16 solenoids)
03	3 stations	
⋮	⋮	
16	16 stations	

A, B port size

M5	M5 x 0.8
----	----------

A, B port size

01	1/8
----	-----

CE-compliant

NII	—
Q	CE-compliant

P, R, A, B port thread type

NII	Rc
F	G
N	NPT
T	NPTF

A, B port size

C4	One-touch fitting for ø4
N3	One-touch fitting for ø5/32"

SI unit part no.

Symbol	SI unit specifications	SI unit part no.	Page
NII	NPN output (+ COM.)	EX510-S001	P.2143
N	PNP output (- COM.)	EX510-S101	

Refer to page 2124 and the Operation Manual for the details of EX510 Gateway-type Serial Transmission System. Please download the Operation Manual via our website, <http://www.smcworld.com>

How to Order Valve

SYJ5 **1** **43** - **5LO** **Z** - **□** - **□**

Type of actuation

1	2 position single
2	2 position double
3	3 position closed center
4	3 position exhaust center
5	3 position pressure center

Coil specifications

NII	Standard
T	With power saving circuit

Rated voltage: 24 VDC

Light/Surge voltage suppressor

Z	With light/surge voltage suppressor
U	Without light/surge voltage suppressor (non-polar type)

* Power saving circuit is only available in the "Z" type.

Manual override

NII	Non-locking push type
D	Push-turn locking slotted type
E	Push-turn locking lever type

CE-compliant

NII	—
Q	CE-compliant

How to Order Manifold Assembly (Example)

Example

SS5YJ5-41SA-05-M5 (-Q) ... 1 set (Type 41SA 5-station manifold part no.)
*** SYJ5143-5LOU (-Q) ... 3 sets (Single solenoid part no.)**
*** SYJ5243-5LOU (-Q) ... 2 sets (Double solenoid part no.)**

The asterisk denotes the symbol for assembly. Prefix it to the part nos. of the solenoid valve, etc.

Add the valve and option part numbers under the manifold base part number. In the case of complex arrangement, specify them on the manifold specification sheet. The connector assembly lead wire length used for EX510 manifold varies depending on the number of stations. Therefore, solenoid valves (including a blanking plate) and connector assembly are assembled when shipped as a standard specification. Please specify the mounting solenoid valve when ordering.

SJ
 SY
 SY
 SV
 SYJ
 SZ
 VF
 VP4
 S0700
 VQ
 VQ4
 VQ5
 VQC
 VQC4
 VQZ
 SQ
 VFS
 VFR
 VQ7

Note) AC-type models that are CE-compliant have DIN terminals only.

[Option]

Common SUP/Common EXH

Note) For more than 8 stations, supply air to both sides of P port and exhaust air from both sides of R port.

Type 20 (5 port/Body ported)

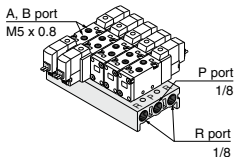

How to Order

SS5YJ5-20-05-□-□

Number of stations

02	2 stations
:	:
20	20 stations

P, R port thread type

Nil	Rc
00F	G
00N	NPT
00T	NPTF

CE-compliant

Nil	—
Q	CE-compliant

Applicable solenoid valve

SYJ5□20-□□□□^{M5}
C4 N3 (-Q)
C6 N7
SYJ5□23-□□□□^{M5}
C4 N3 (-Q)
C6 N7

Applicable blanking plate assembly

Refer to page 706.

Applicable individual EXH spacer assembly

Refer to page 707.

Type 40 (5 port/Base mounted)

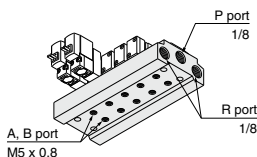

How to Order

SS5YJ5-40-05-M5-□-□

Stations

02	2 stations
:	:
20	20 stations

P, R port thread type

Nil	Rc
F	G
N	NPT
T	NPTF

A, B port size

M5	M5 x 0.8
----	----------

CE-compliant

Nil	—
Q	CE-compliant

Applicable solenoid valve

SYJ5□40-□□□□(-Q)
SYJ5□43-□□□□(-Q)
SYJ5□50-□□□□(-Q)
SYJ5□53-□□□□(-Q)

Applicable blanking plate assembly

Refer to page 706.

Applicable individual EXH spacer assembly

Refer to page 707.

Applicable individual SUP spacer assembly

Refer to page 708.

Type 41 (5 port/Base mounted)

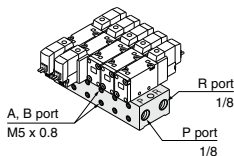

How to Order

SS5YJ5-41-05-M5-□-□

Stations

02	2 stations
:	:
20	20 stations

P, R port thread type

Nil	Rc
F	G
N	NPT
T	NPTF

A, B port size

M5	M5 x 0.8
----	----------

CE-compliant

Nil	—
Q	CE-compliant

Type 42 (5 port/Base mounted)

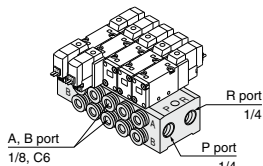

How to Order

SS5YJ5-42-05-C6-□-□

Stations

02	2 stations
:	:
20	20 stations

Thread type

Nil	Rc
F	G
N	NPT
T	NPTF

A, B port size

01	1/8
C6	One-touch fitting for ø6
N7	One-touch fitting for ø1/4"

CE-compliant

Nil	—
Q	CE-compliant

Applicable solenoid valve

SYJ5□40-□□□□(-Q)
SYJ5□43-□□□□(-Q)
SYJ5□50-□□□□(-Q)
SYJ5□53-□□□□(-Q)

Applicable blanking plate assembly

Refer to page 706.

Applicable individual EXH spacer assembly

Refer to page 707.

Applicable individual SUP spacer assembly

Refer to page 707.

Type 43 (5 port/Base mounted)

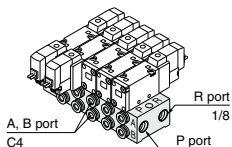

How to Order

SS5YJ5-43-05-C4-□-□

Stations

02	2 stations
:	:
20	20 stations

P, R port thread type

Nil	Rc
F	G
N	NPT
T	NPTF

A, B port size

C4	One-touch fitting for ø4
N3	One-touch fitting for ø5/32"

CE-compliant

Nil	—
Q	CE-compliant

Applicable individual SUP spacer assembly

Refer to page 708.



Flat Ribbon Cable Manifold

Note) CE-compliant: For DC only. [Option]

Common SUP/Common EXH

Note) For more than 8 stations, supply air to both sides of P port and exhaust air from both sides of R port.

Type 20P (5 port/Body ported)

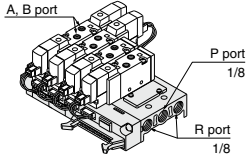

How to Order

SS5YJ5-20P-05-□-□-□

Number of stations

03	3 stations
:	:
12	12 stations

P, R port thread type

Nil	Rc
00F	G
00N	NPT
00T	NPTF

CE-compliant

Nil	—
Q	CE-compliant

Applicable solenoid valve
Refer to page 700.

Applicable blanking plate assembly
Refer to page 706.

Applicable connector assembly
Refer to page 700.

Type 41P (5 port/Base mounted)

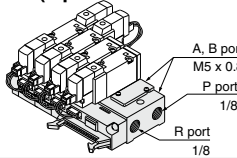

How to Order

SS5YJ5-41P-05-M5-□-□-□

Number of stations

03	3 stations
:	:
12	12 stations

P, R port thread type

Nil	Rc
F	G
N	NPT
T	NPTF

CE-compliant

Nil	—
Q	CE-compliant

Applicable solenoid valve
Refer to page 700.

Applicable blanking plate assembly
Refer to page 706.

Type 43P (5 port/Base mounted)

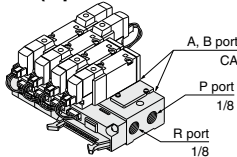

How to Order

SS5YJ5-43P-05-C4-□-□-□

Number of stations

03	3 stations
:	:
12	12 stations

A, B port size

C4	One-touch fitting for ø4
N3	One-touch fitting for ø5/32"

P, R port thread type

Nil	Rc
F	G
N	NPT
T	NPTF

CE-compliant

Nil	—
Q	CE-compliant

Applicable solenoid valve
Refer to page 700.

Applicable connector assembly
Refer to page 700.

EX510 Gateway-type Serial Transmission System

Type 20SA (5 port/Body ported)

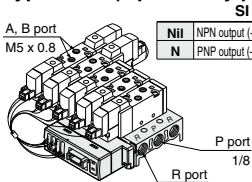

How to Order

SS5YJ5-20SA-□-03-□-□-□

SI unit

Nil	NPN output (+COM.)
N	PNP output (-COM.)

Valve stations

Symbol	Station	Note
03	3 stations	
:	:	
08	8 stations	Double wiring Note 1)
03	3 stations	Specified layout Note 2)
:	:	(Up to 16 solenoids)
16	16 stations	

CE-compliant

Nil	—
Q	CE-compliant

Applicable solenoid valve
Refer to page 702.

Applicable blanking plate assembly
Refer to page 706.

Note 1) Double wiring: Use of a single solenoid will result in an unused control signal. If this is not desired, order with a specified layout.
Note 2) Specified layout: Indicate wiring specifications on the manifold specification sheet. (Note that double and 3 position valves cannot be used where single solenoid wiring has been specified.)

Type 41SA (5 port/Base mounted)

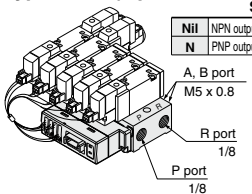

How to Order

SS5YJ5-41SA-□-03-M5-□-□-□

SI unit

Nil	NPN output (+COM.)
N	PNP output (-COM.)

Valve stations

Symbol	Station	Note
03	3 stations	
:	:	
08	8 stations	Double wiring Note 1)
03	3 stations	Specified layout Note 2)
:	:	(Up to 16 solenoids)
16	16 stations	

A, B port size

M5	M5 x 0.8
----	----------

CE-compliant

Nil	—
Q	CE-compliant

Applicable solenoid valve
Refer to page 703.

Applicable blanking plate assembly
Refer to page 706.

Note 1) Double wiring: Use of a single solenoid will result in an unused control signal. If this is not desired, order with a specified layout.
Note 2) Specified layout: Indicate wiring specifications on the manifold specification sheet. (Note that double and 3 position valves cannot be used where single solenoid wiring has been specified.)

Type 42SA (5 port/Base mounted)

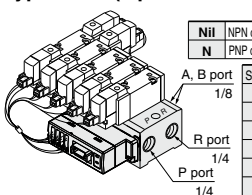

How to Order

SS5YJ5-42SA-□-03-01-□-□-□

SI unit

Nil	NPN output (+COM.)
N	PNP output (-COM.)

Valve stations

Symbol	Station	Note
03	3 stations	
:	:	
08	8 stations	Double wiring Note 1)
03	3 stations	Specified layout Note 2)
:	:	(Up to 16 solenoids)
16	16 stations	

A, B port size

01	1/8
----	-----

P, R port thread type

Nil	Rc
F	G
N	NPT
T	NPTF

CE-compliant

Nil	—
Q	CE-compliant

Applicable solenoid valve
Refer to page 703.

Applicable blanking plate assembly
Refer to page 706.

Series SYJ5000



Flat Ribbon Cable Manifold

EX510 Gateway-type Serial Transmission System

Type 43SA (5 port/Base mounted) How to Order

SS5YJ5-43SA [] - **03** - **C4** [] - []

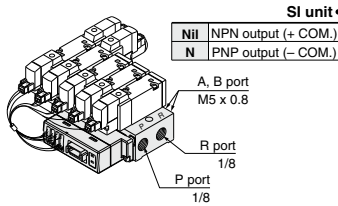

Nil	NPN output (+ COM.)
N	PNP output (- COM.)

SI unit

Symbol	Station	Note
03	3 stations	Double wiring (Note 1)
:	:	
08	8 stations	Specified layout (Note 2) (Up to 16 solenoids)
:	:	
16	16 stations	

Valve stations

P, R, A, B port thread type	
Nil	Rc
F	G
N	NPT
T	NPTF

A, B port size

C4	One-touch fitting for ø4
N3	One-touch fitting for ø5/32"

Applicable solenoid valve
Refer to page 703.

Applicable blanking plate assembly
Refer to "Blanking Plate Assembly" below.

CE-compliant

Nil	—
Q	CE-compliant

The number of the blanking plate assembly is also included.
Note 1) Double wiring: Use of a single solenoid will result in an unused control signal. If this is not desired, order with a specified layout.
Note 2) Specified layout: Indicate wiring specifications on the manifold specification sheet. (Note that double and 3 position valves cannot be used where single solenoid wiring has been specified.)

Combinations of Solenoid Valve, Manifold Gasket and Manifold Base

<Standard>

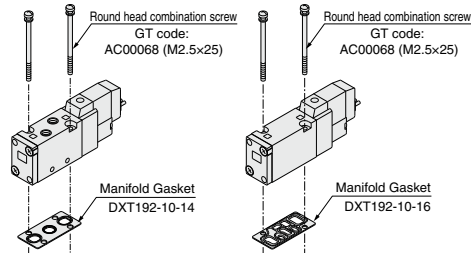

Applicable manifold base
· Type SS5YJ5-20
· Type SS5YJ5-20P
· Type SS5YJ5-20SA

Applicable manifold base
Sub-plate
· Type SS5YJ5-40 · Type SS5YJ5-41P
· Type SS5YJ5-40 · Type SS5YJ5-43P
· Type SS5YJ5-41 · Type SS5YJ5-41SA
· Type SS5YJ5-42 · Type SS5YJ5-42SA
· Type SS5YJ5-43 · Type SS5YJ5-43SA

<CE-compliant>

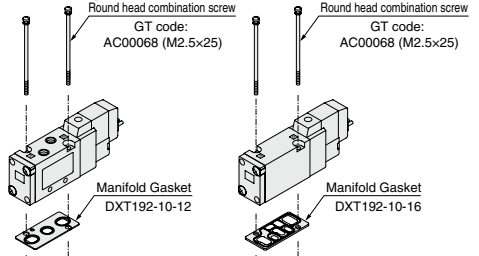

Applicable manifold base
· Type SS5YJ5-20-Q
· Type SS5YJ5-20P-Q
· Type SS5YJ5-20SA-Q

Applicable manifold base
Sub-plate
· Type SS5YJ5-41P-Q
· Type SS5YJ5-40-Q · Type SS5YJ5-43P-Q
· Type SS5YJ5-41-Q · Type SS5YJ5-41SA-Q
· Type SS5YJ5-42-Q · Type SS5YJ5-42SA-Q
· Type SS5YJ5-43-Q · Type SS5YJ5-43SA-Q

Blanking Plate Assembly

SYJ5000-21-5A

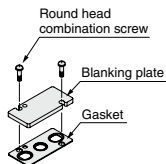

Applicable manifold base
· SS5YJ5-20(-Q)
· SS5YJ5-20SA(-Q)

SYJ5000-21-6A

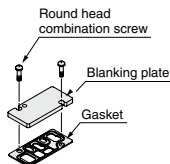

Applicable manifold base
· SS5YJ5-40(-Q)
· SS5YJ5-41(-Q)
· SS5YJ5-42(-Q)
· SS5YJ5-43(-Q)
· SS5YJ5-41SA(-Q)
· SS5YJ5-42SA(-Q)
· SS5YJ5-43SA(-Q)

SYJ5000-21-7A

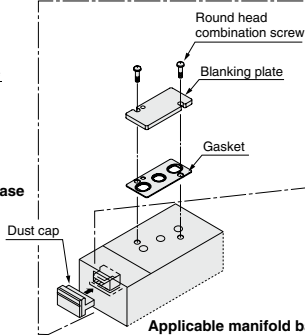

Applicable manifold base
· SS5YJ5-20P(-Q)

SYJ5000-21-8A

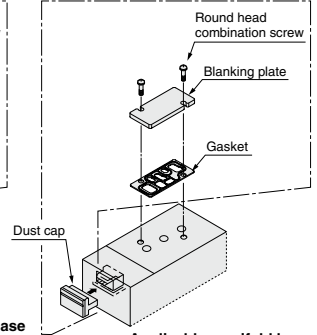

Applicable manifold base
· SS5YJ5-41P(-Q)
· SS5YJ5-43P(-Q)

Caution

Mounting screw tightening torques
M2.5: 0.45N·m

Use caution to the assembly orientation for solenoid valves, gasket, and optional parts.

Mix Installation of the SYJ500 and the SYJ5000 Valves on the Same Manifold

- Use of an adapter plate makes it possible to mount Series SYJ500 on the manifold bases of series SYJ5000.
- When mounting the SYJ500 valve on the SYJ5000 manifold, the SYJ500 solenoid must be positioned on the same side of the manifold as a single solenoid SYJ500. (Refer to the figure below.)
- For base mounted style, the A port of the 3 port valve flows out the B port of manifold base.

Adapter Plate Assembly

<Standard>

SYJ5000-3-2A

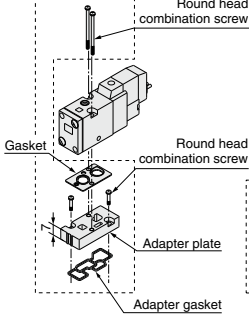

Applicable manifold base

- Type SS5YJ5-20
- Type SS5YJ5-20P

SYJ500-3-1A

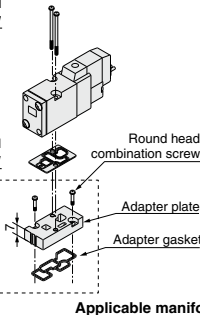

Applicable manifold base

- Type SSSYJ5-40
- Type SSSYJ5-41
- Type SSSYJ5-42
- Type SSSYJ5-43
- Type SSSYJ5-41P
- Type SSSYJ5-42P
- Type SSSYJ5-43P

<CE-compliant>

SYJ5000-3-1A-1-Q

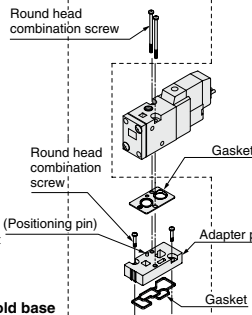

Applicable manifold base

- Type SS5YJ5-20-Q
- Type SS5YJ5-20P-Q

SYJ500-3-1A-2-Q

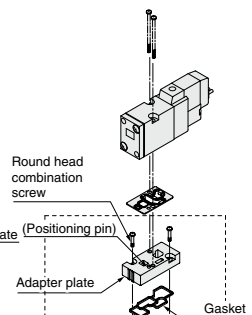

Applicable manifold base

- Type SS5YJ5-40-Q
- Type SS5YJ5-41-Q
- Type SS5YJ5-42-Q
- Type SS5YJ5-43-Q
- Type SS5YJ5-41P-Q
- Type SS5YJ5-43P-Q

Individual EXH Spacer Assembly

SYJ5000-17-3A

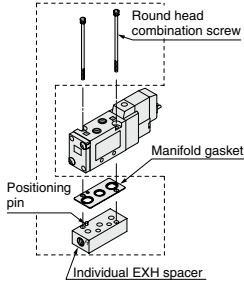

Applicable manifold base

- SS5YJ5-20(-Q)
- SS5YJ5-20P(-Q)

SYJ5000-17-4A

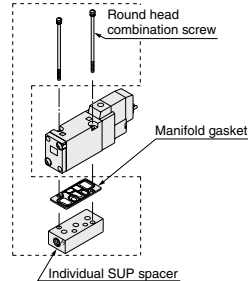

Applicable manifold base

- SS5YJ5-40(-Q)
- SS5YJ5-41(-Q)
- SS5YJ5-42(-Q)
- SS5YJ5-43(-Q)
- SS5YJ5-41P(-Q)
- SS5YJ5-43P(-Q)

Individual SUP Spacer Assembly

SYJ5000-16-2 A(-Q)

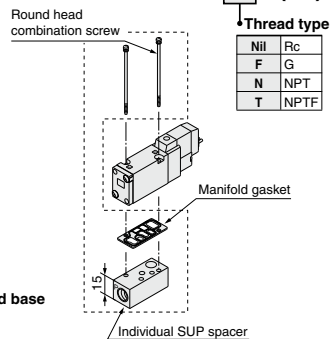

Applicable manifold base

- Type SS5YJ5-41(-Q)
- Type SS5YJ5-42(-Q)
- Type SS5YJ5-43(-Q)
- Type SS5YJ5-41P(-Q)
- Type SS5YJ5-43P(-Q)

⚠ Caution

Mounting screw tightening torques

M2.5: 0.45 N·m

Use caution to the assembly orientation for solenoid valves, gasket, and optional parts.

SYJ
SY
SV
SYJ
SZ
VF
VP4
S0700
VQ
VQ4
VQ5
VQC
VQC4
VQZ
SQ
VFS
VFR
VQ7

Series SYJ5000

Interface Regulator (P port regulation)

Spacer type regulating valve on manifold block can regulate the pressure to the valve individually.

ARBYJ5000-00-P(-Q)

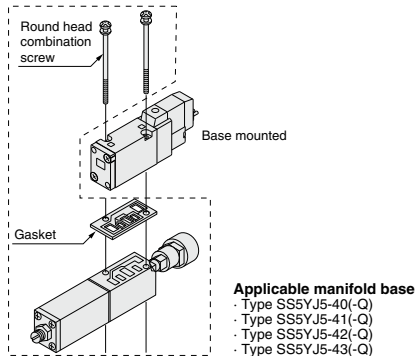

* Refer to page 757 prior to handling.

Caution

Mounting screw tightening torques

M2.5: 0.45 N·m

Use caution to the assembly orientation for solenoid valves, gasket, and optional parts.

Type 20: Top Ported/SS5YJ5-20- Stations -00□

* [] : AC

Grommet (G)

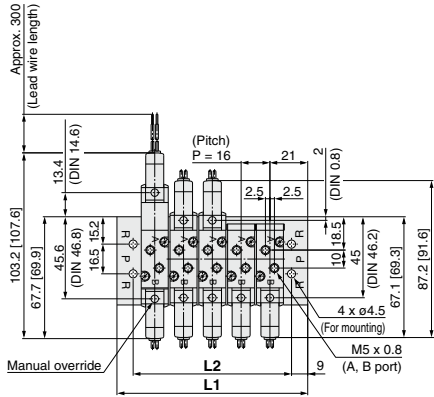

(Station n) - - - - - (Station 1)

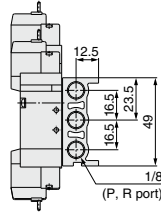
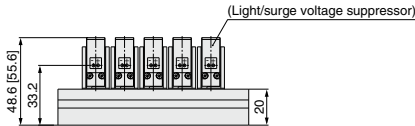

For C4, N3, C6, N7
(Built-in One-touch fitting)

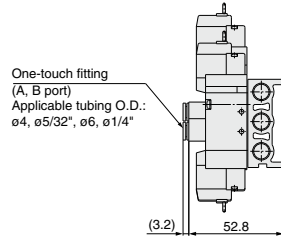

L plug connector (L)

M plug connector (M)

DIN terminal (D, Y)

M8 connector (WO)

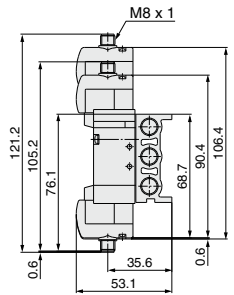
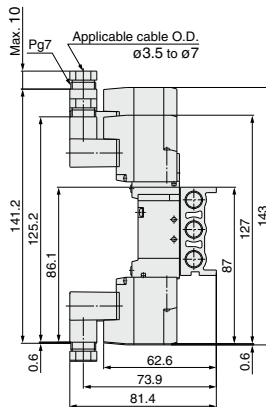
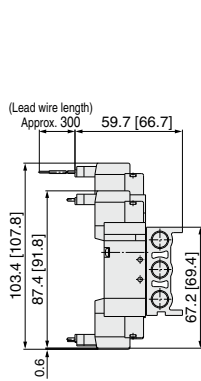
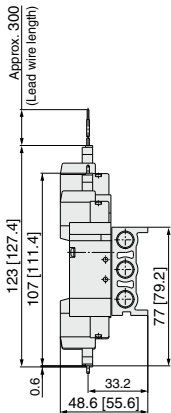

* Refer to page 755 for dimensions with connector cable.

Station n	Station 2	3	4	5	6	7	8	9	10	11	12	13	14	15	16	17	18	19	Station 20
L1	58	74	90	106	122	138	154	170	186	202	218	234	250	266	282	298	314	330	346
L2	40	56	72	88	104	120	136	152	168	184	200	216	232	248	264	280	296	312	328

SJ
SY
SY
SV
SYJ
SZ
VF
VP4
S0700
VQ
VQ4
VQ5
VQC
VQC4
VQZ
SQ
VFS
VFR
VQ7

Series SYJ5000

Type 40: Bottom Ported/SS5YJ5-40-Stations-M5□

* [] : AC

Grommet (G)

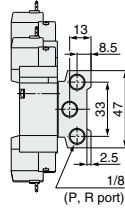
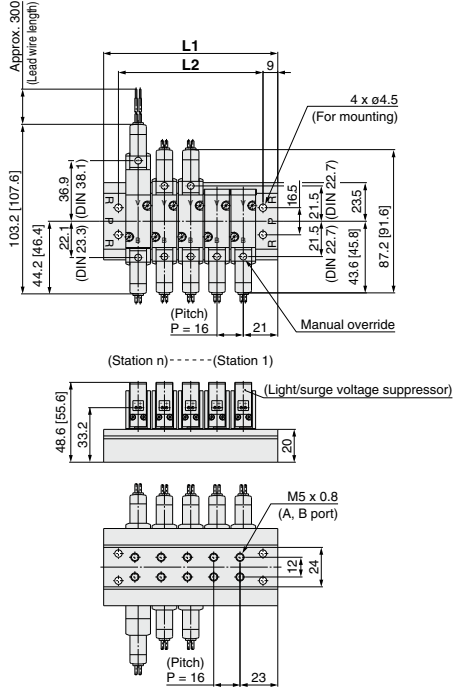

Built-in speed controller

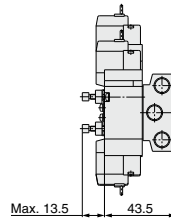

L plug connector (L)

M plug connector (M)

DIN terminal (D, Y)

M8 connector (WO)

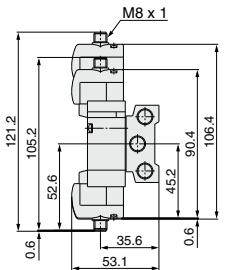
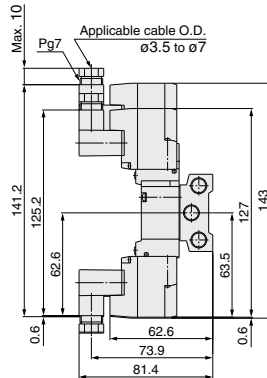
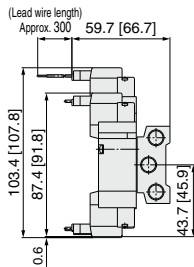
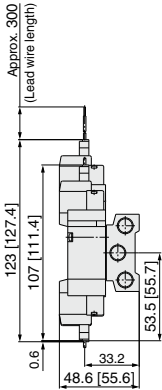

* Refer to page 755 for dimensions with connector cable.

Station n	Station 2	3	4	5	6	7	8	9	10	11	12	13	14	15	16	17	18	19	Station 20
L1	58	74	90	106	122	138	154	170	186	202	218	234	250	266	282	298	314	330	346
L2	40	56	72	88	104	120	136	152	168	184	200	216	232	248	264	280	296	312	328

Type 41: Side Ported/SS5YJ5-41- Stations -M5□

* []: AC

Grommet (G)

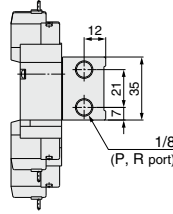
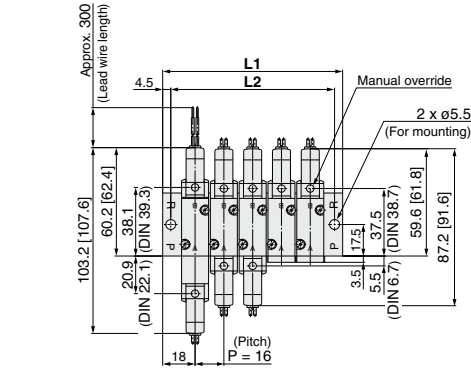

Built-in speed controller

(Light/surge voltage suppressor)

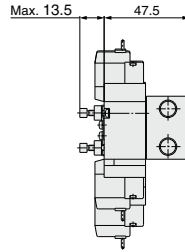
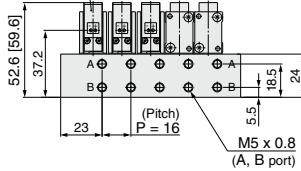

L plug connector (L)

M plug connector (M)

DIN terminal (D, Y)

M8 connector (WO)

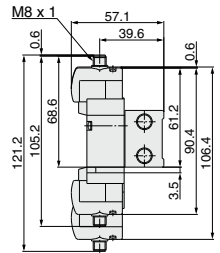
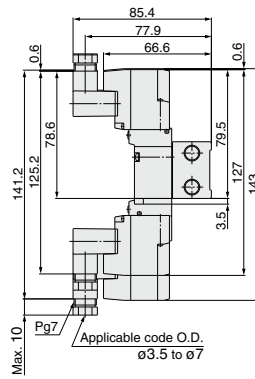
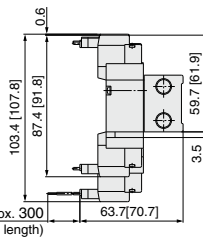
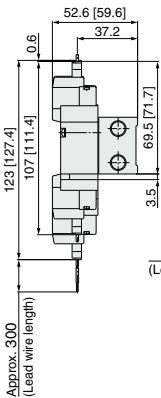

* Refer to page 755 for dimensions with connector cable.

Station n	Station 2	3	4	5	6	7	8	9	10	11	12	13	14	15	16	17	18	19	Station 20
L1	52	68	84	100	116	132	148	164	180	196	212	228	244	260	276	292	308	324	340
L2	43	59	75	91	107	123	139	155	171	187	203	219	235	251	267	283	299	315	331

SJ
SY
SY
SV
SYJ
SZ
VF
VP4
S0700
VQ
VQ4
VQ5
VQC
VQC4
VQZ
SQ
VFS
VFR
VQ7

Series SYJ5000

Type 42: Side Ported/SS5YJ5-42-Stations-01, C6 N7 □

* []: AC

Grommet (G)

For 01 □

For C6 N7 □ (Built-in One-touch fitting)

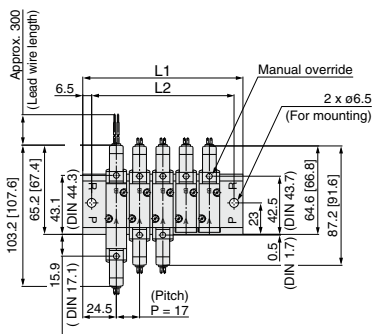

(Station 1) ---- (Station n)

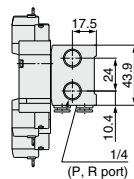
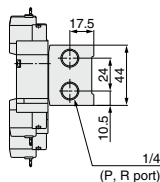

(Light/surge voltage suppressor)

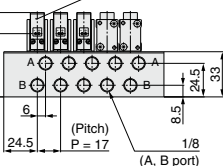

Built-in speed controller

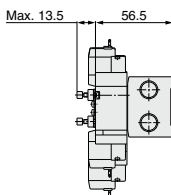

(Station 1) ---- (Station n)

(Light/surge voltage suppressor)

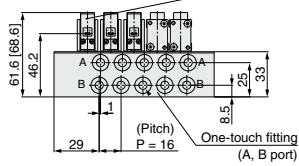

Applicable tubing O.D.: ø6, ø1/4"

* Other dimensions are the same as the grommet type.

L plug connector (L)

M plug connector (M)

DIN terminal (D, Y)

M8 connector (WO)

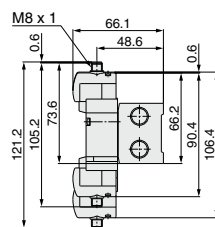
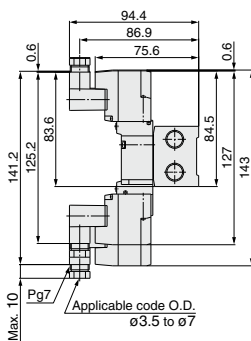
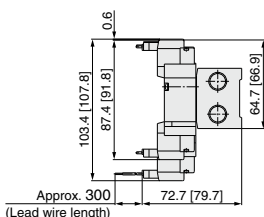
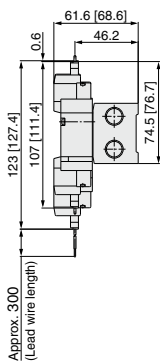

* Refer to page 755 for dimensions with connector cable.

A/B port size	Station n	Station 2	3	4	5	6	7	8	9	10	11	12	13	14	15	16	17	18	19	Station 20
For 1/8	L1	66	83	100	117	134	151	168	185	202	219	236	253	270	287	304	321	338	355	372
	L2	53	70	87	104	121	138	155	172	189	206	223	240	257	274	291	308	325	342	359
For C6/N7	L1	65	81	97	113	129	145	161	177	193	209	225	241	257	273	289	305	321	337	353
	L2	52	68	84	100	116	132	148	164	180	196	212	228	244	260	276	292	308	324	340

Type 43: Side Ported/SS5YJ3-43-Stations - C4 N3

* [] : AC

Grommet (G)

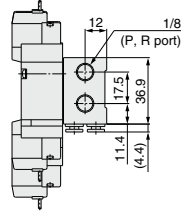
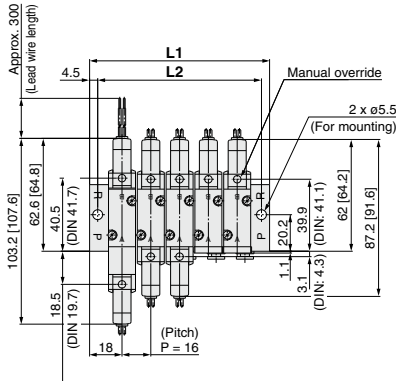

Built-in slottle valve

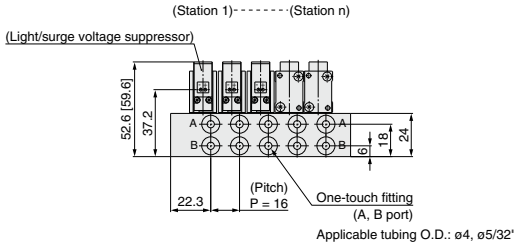
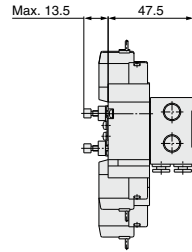

L plug connector (L)

M plug connector (M)

DIN terminal (D, Y)

M8 connector (WO)

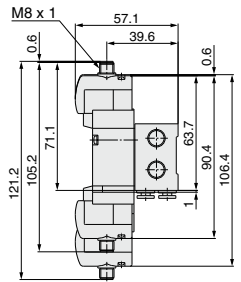
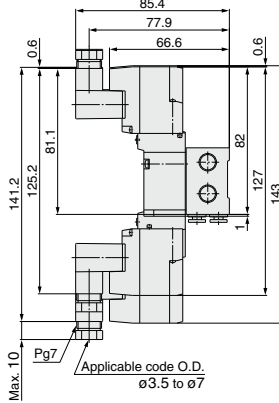
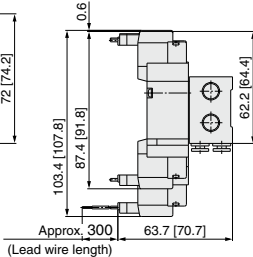
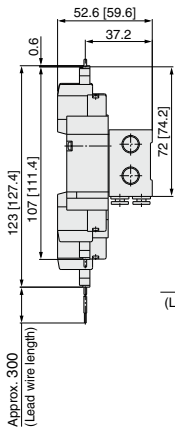

* Refer to page 755 for dimensions with connector cable.

Station n	Station 2	3	4	5	6	7	8	9	10	11	12	13	14	15	16	17	18	19	Station 20
L1	52	68	84	100	116	132	148	164	180	196	212	228	244	260	276	292	308	324	340
L2	43	59	75	91	107	123	139	155	171	187	203	219	235	251	267	283	299	315	331

- SJ
- SY
- SY
- SV
- SYJ**
- SZ
- VF
- VP4
- S0700
- VQ
- VQ4
- VQ5
- VQC
- VQC4
- VQZ
- SQ
- VFS
- VFR
- VQ7

Series SYJ5000

Flat Ribbon Cable Manifold

* []: AC

SS5YJ5-20P- Stations -00

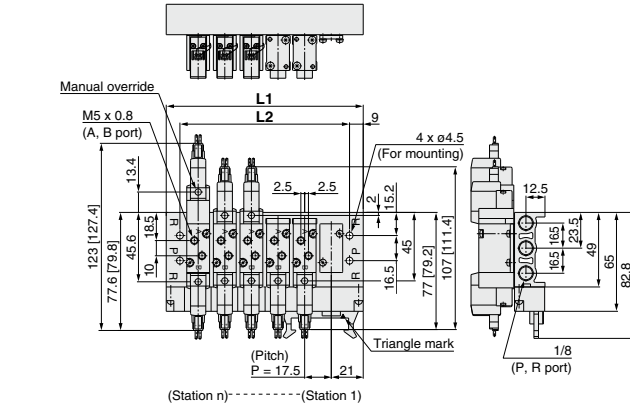

For C4 N3
C6 N7 (Built-in One-touch fitting)

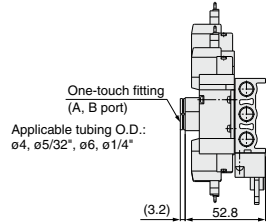

(Light/surge voltage suppressor)

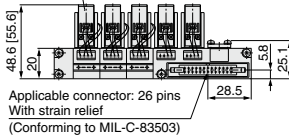

Station n	Station 3	4	5	6	7	8	9	10	11	Station 12
L1	77	94.5	112	129.5	147	164.5	182	199.5	217	234.5
L2	59	76.5	94	111.5	129	146.5	164	181.5	199	216.5

SS5YJ5-41P- Stations -M5

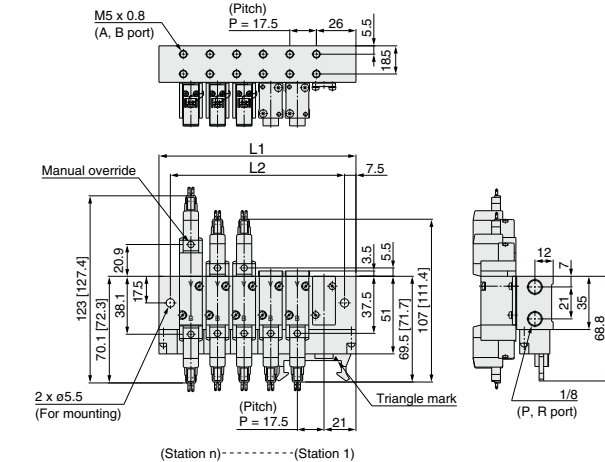

Built-in slottle valve

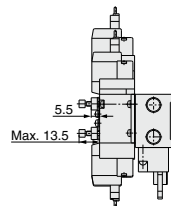

(Light/surge voltage suppressor)

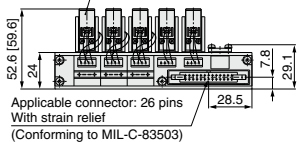

Station n	Station 3	4	5	6	7	8	9	10	11	Station 12
L1	77	94.5	112	129.5	147	164.5	182	199.5	217	234.5
L2	62	79.5	97	114.5	132	149.5	167	184.5	202	219.5

Flat Ribbon Cable Manifold

* [] : AC

SS5YJ5-43P- Stations - C4 N3

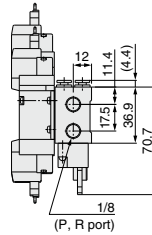
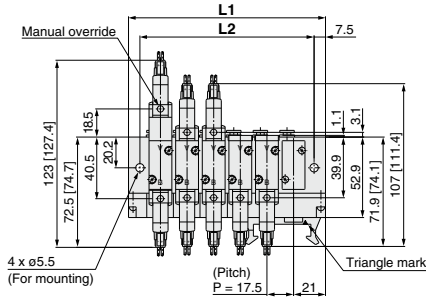
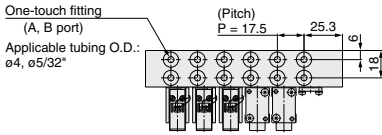

Built-in speed controller

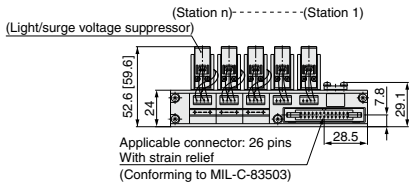
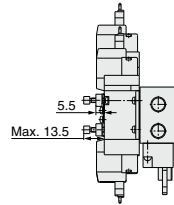

Station n	Station 3	4	5	6	7	8	9	10	11	Station 12
L1	77	94.5	112	129.5	147	164.5	182	199.5	217	234.5
L2	62	79.5	97	114.5	132	149.5	167	184.5	202	219.5

- SJ
- SY
- SY
- SV
- SYJ**
- SZ
- VF
- VP4
- S0700
- VQ
- VQ4
- VQ5
- VQC
- VQC4
- VQZ
- SQ
- VFS
- VFR
- VQ7

Series SYJ5000

EX510 Gateway-type Serial Transmission System

SS5YJ5-20SA□ - Stations - □

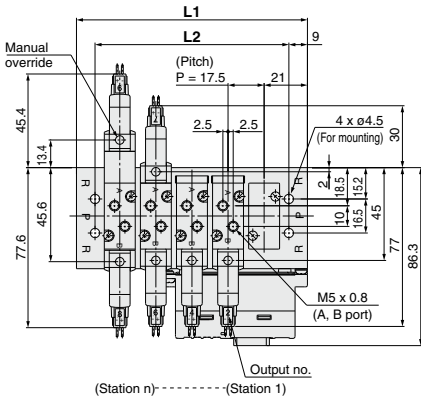
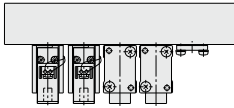

For C4, N3 (Built-in One-touch fitting)
C6, N7

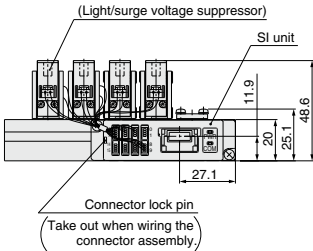
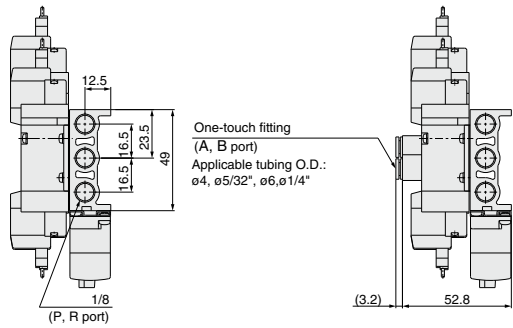

Station n	Station 3	4	5	6	7	8	9	10	11	12	13	14	15	Station 16
L1	77	94.5	112	129.5	147	164.5	182	199.5	217	234.5	252	269.5	287	304.5
L2	59	76.5	94	111.5	129	146.5	164	181.5	199	216.5	234	251.5	269	286.5

EX510 Gateway-type Serial Transmission System

SS5YJ5-41SA□ - Stations - M5□

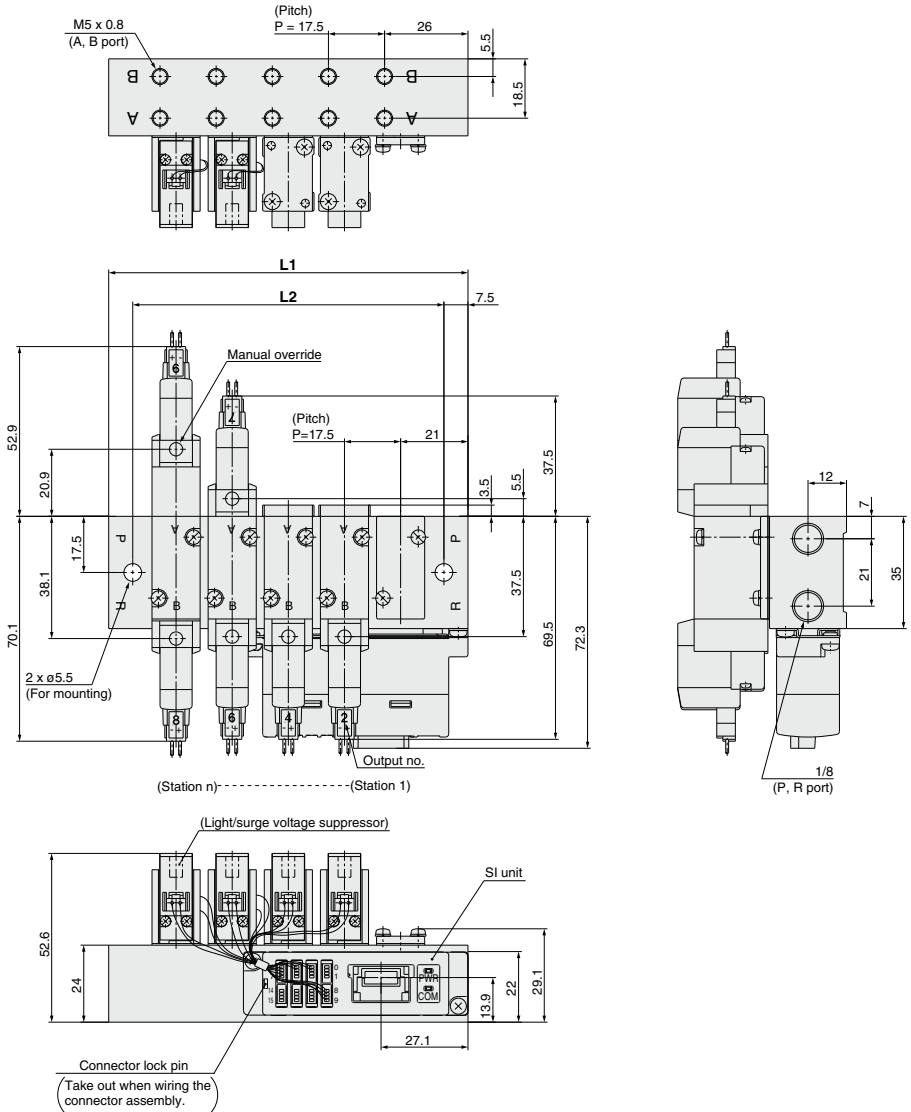

- SJ
- SY
- SY
- SV
- SYJ**
- SZ
- VF
- VP4
- S0700
- VQ
- VQ4
- VQ5
- VQC
- VQC4
- VQZ
- SQ
- VFS
- VFR
- VQ7

Station n	Station 3	4	5	6	7	8	9	10	11	12	13	14	15	Station 16
L1	77	94.5	112	129.5	147	164.5	182	199.5	217	234.5	252	269.5	287	304.5
L2	62	79.5	97	114.5	132	149.5	167	184.5	202	219.5	237	254.5	272	289.5

Series SYJ5000

EX510 Gateway-type Serial Transmission System

SS5YJ-42SA□ - Stations -01□

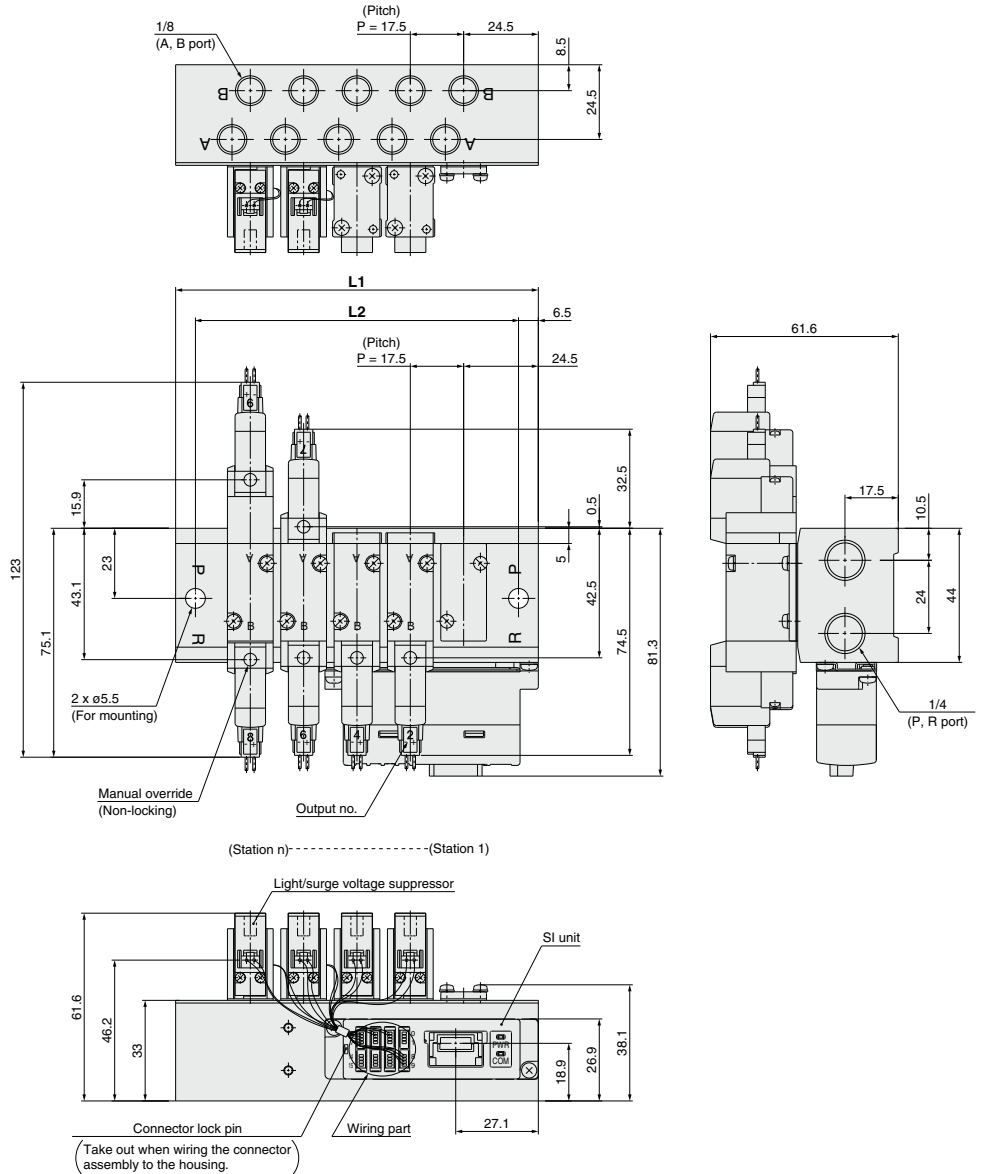

Station n	Station 4	5	6	7	8	9	10	11	12	13	14	15	Station 16
L1	101.5	119	136.5	154	171.5	189	206.5	224	241.5	259	276.5	294	311.5
L2	88.5	106	123.5	141	158.5	176	193.5	211	228.5	246	263.5	281	298.5

EX510 Gateway-type Serial Transmission System

SS5YJ5-43SA□ - Stations - C4□
N3□

One-touch fitting
(A, B port)
Applicable tubing O.D.: $\phi 4, \phi 5/32''$

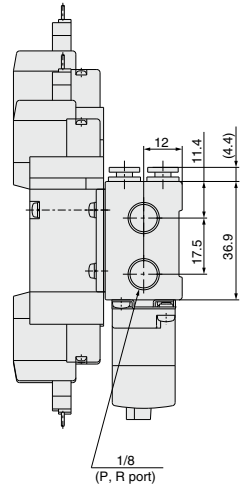
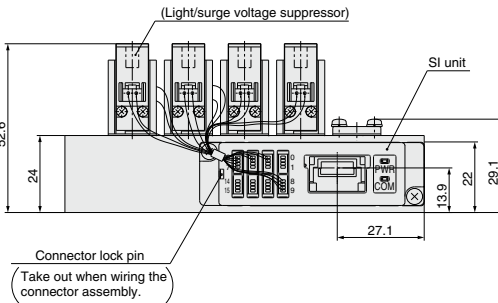
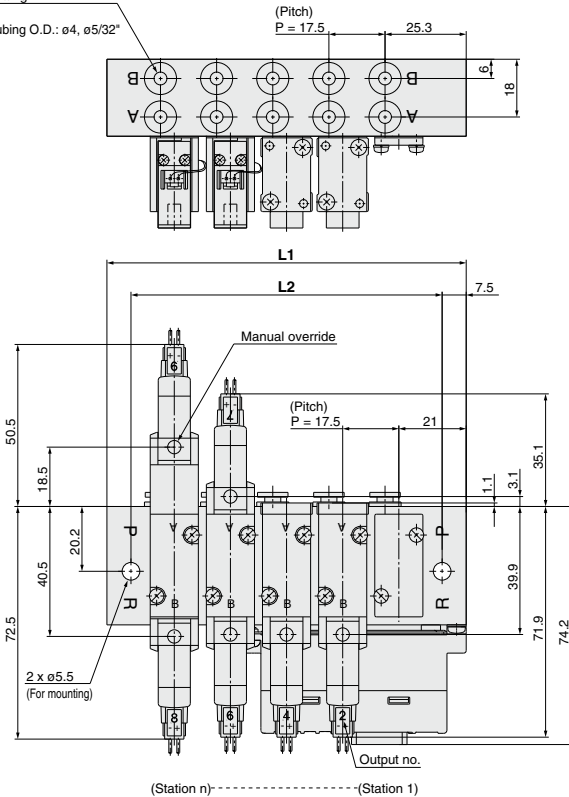

- SJ
- SY
- SY
- SV
- SYJ**
- SZ
- VF
- VP4
- S0700
- VQ
- VQ4
- VQ5
- VQC
- VQC4
- VQZ
- SQ
- VFS
- VFR
- VQ7

Station n	Station 3	4	5	6	7	8	9	10	11	12	13	14	15	Station 16
L1	77	94.5	112	129.5	147	164.5	182	199.5	217	234.5	252	269.5	287	304.5
L2	62	79.5	97	114.5	132	149.5	167	184.5	202	219.5	237	254.5	272	289.5

Rubber Seal 5 Port Solenoid Valve

Series SYJ7000



Specifications

Fluid		Air
Operating pressure range (MPa)	2 position single	0.15 to 0.7
	2 position double	0.1 to 0.7
	3 position	0.15 to 0.7
Ambient and fluid temperature (°C)		-10 to 50 (No freezing)
Response time (ms) ^{Note 1)} (at 0.5 MPa)	2 position single, double	30 or less
	3 position	60 or less
Max. operating frequency (Hz)	2 position single, double	5
	3 position	3
Manual override (Manual operation)		Non-locking push type, Push-turn locking slotted type, Push-turn locking lever type
Pilot exhaust method		Individual exhaust for the pilot valve, Common exhaust for the pilot and main valve
Lubrication		Not required
Mounting orientation		Unrestricted
Impact/Vibration resistance (m/s ²) ^{Note 2)}		150/30
Enclosure		Dust proof (* M8 connector conforms to IP65.)

* Based on IEC60529

Note 1) Based on dynamic performance test, JIS B 8375-1981. (Coil temperature: 20°C, at rated voltage, without surge suppressor)

Note 2) Impact resistance:

No malfunction occurred when it is tested in the axial direction and at the right angles to the main valve and armature in both energized and de-energized states every once for each condition. (Value in the initial state)

Vibration resistance:

No malfunction occurred in one sweep test between 45 and 2000 Hz. Test was performed at both energized and de-energized states in the axial direction and at the right angles to the main valve and armature. (Value in the initial state)

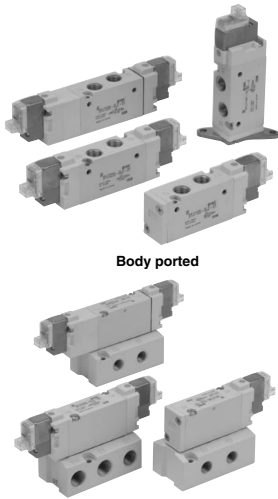

Body ported

Base mounted

Symbol

Body ported

2 position single

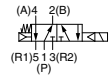

2 position double

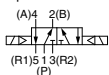

3 position closed center

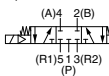

3 position exhaust center

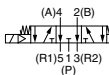

3 position pressure center

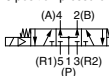

Base mounted

2 position single solenoid

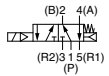

2 position double solenoid

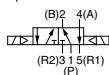

3 position closed center

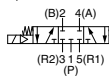

3 position exhaust center

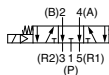

3 position pressure center

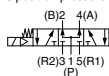

Solenoid Specifications

Electrical entry		Grommet (G), (H)	
		L plug connector (L)	
Coil rated voltage (V)		DC	24, 12, 6, 5, 3
		AC 50/60 Hz	100, 110, 200, 220
Allowable voltage fluctuation		±10% of rated voltage *	
Power consumption (W)	DC	Standard	0.35 (With light: 0.4 (DIN terminal with light: 0.45))
		With power saving circuit	0.1 (With light only) * [Starting 0.4, Holding 0.1]
Apparent power (VA) *	AC	100 V	0.78 (With light: 0.81) 0.78 (With light: 0.87)
		110 V	0.86 (With light: 0.89) 0.86 (With light: 0.97)
		[115 V]	[0.94 (With light: 0.97)] [0.94 (With light: 1.07)]
		200 V	1.18 (With light: 1.22) 1.15 (With light: 1.30)
		220 V	1.30 (With light: 1.34) 1.27 (With light: 1.46)
		[230 V]	[1.42 (With light: 1.46)] [1.39 (With light: 1.60)]
Surge voltage suppressor		Diode (DIN terminal, Varistor when non-polar types)	
Indicator light		LED (Neon light when AC with DIN terminal)	

* In common between 110 VAC and 115 VAC, and between 220 VAC and 230 VAC.

* For 115 VAC and 230 VAC, the allowable voltage is -15% to +5% of rated voltage.

* For details refer to page 752.



Made to Order

(For details, refer to pages 748 and 749.)

Flow Characteristics/Weight

Valve model	Type of actuation	Port size		Flow characteristics <small>Note 1)</small>						Weight (g) <small>Note 2, 3)</small>					
		1, 5, 3 (P,EA,EB)	4, 2 (A,B)	1P4/2 (PPA/B)			4/2P5/3 (A/BPEA/EB)			Grommet	L/M plug connector	DIN terminal	M8 connector		
				C [dm ³ /(s·bar)]	b	Cv	C [dm ³ /(s·bar)]	b	Cv						
Body ported	SYJ7□20-□-01	2 position	Single	1/8	1/8	2.2	0.36	0.58	2.4	0.34	0.63	85	86	107	90
			Double			1.8	0.37	0.45	2.0	0.35	0.49	98	100	142	108
		3 position	Closed center			1.2	0.50	0.34	3.0 [1.3]	0.35[0.52]	0.73 [0.39]	108	110	152	118
			Exhaust center			3.0 [0.83]	0.37 [0.50]	0.78 [0.25]	1.8	0.37	0.45				
			Pressure center												
	SYJ7□20-□-C6	2 position	Single	1/8	C6 (One-touch fitting for ø6)	1.6	0.33	0.4	2.2	0.32	0.53	96	97	98	101
			Double			1.4	0.27	0.35	1.9	0.33	0.49	109	111	153	119
		3 position	Closed center			1.1	0.37	0.27	2.5 [1.3]	0.35[0.54]	0.61 [0.38]	119	121	163	129
			Exhaust center			1.8 [0.78]	0.36 [0.40]	0.45 [0.22]	1.6	0.30	0.39				
			Pressure center												
SYJ7□20-□-C8	2 position	Single	1/8	C8 (One-touch fitting for ø8)	2.0	0.39	0.52	2.3	0.34	0.61	96	97	98	101	
		Double			1.7	0.35	0.42	2.0	0.29	0.49	109	111	153	119	
	3 position	Closed center			1.2	0.38	0.33	2.6 [1.3]	0.35[0.49]	0.67 [0.38]	119	121	163	129	
		Exhaust center			1.9 [0.86]	0.57 [0.46]	0.59 [0.25]	1.7	0.39	0.42					
		Pressure center													
Base mounted	SYJ7□40-□-01	2 position	Single	1/8	1/8	2.3	0.45	0.57	2.8	0.37	0.71	165 (85) 178 (98)	166 (86) 180 (100)	187 (107) 222 (142)	170 (90) 188 (108)
			Double			1.9	0.36	0.48	2.1	0.46	0.57	188 (108)	190 (110)	232 (152)	198 (118)
		3 position	Closed center			1.2	0.48	0.35	3.4 [1.3]	0.36[0.57]	0.86 [0.41]				
			Exhaust center			3.3 [0.85]	0.43 [0.54]	0.78 [0.25]	2.1	0.45	0.56				
			Pressure center												
	SYJ7□40-□-02	2 position	Single	1/4	1/4	2.3	0.41	0.61	2.9	0.35	0.74	165 (85) 178 (98)	166 (86) 180 (100)	187 (107) 222 (142)	170 (90) 188 (108)
			Double			1.9	0.46	0.50	2.2	0.44	0.60	188 (108)	190 (110)	232 (152)	198 (118)
		3 position	Closed center			1.3	0.45	0.35	3.7 [1.4]	0.27[0.56]	0.87 [0.43]				
			Exhaust center			3.6 [0.83]	0.23 [0.55]	0.84 [0.25]	2.1	0.47	0.58				
			Pressure center												

Note 1) []: denotes the normal position. Exhaust center: 4/2 → 5/3, Pressure center: 1 → 4/2

Note 2) (): Without sub-plat.

Note 3) For DC voltages. For AC voltages add 3 g to the weight of the single solenoid and 6 g to the weight of the double solenoid and 3 position types.

Cylinder Speed Chart

Use as a guide for selection.

Please confirm the actual conditions with SMC Sizing Program.

Body Ported

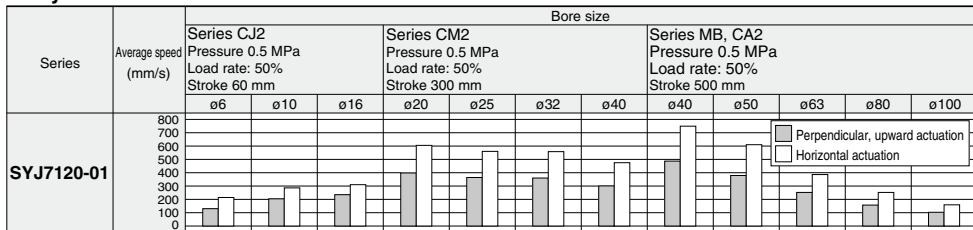

Base Mounted

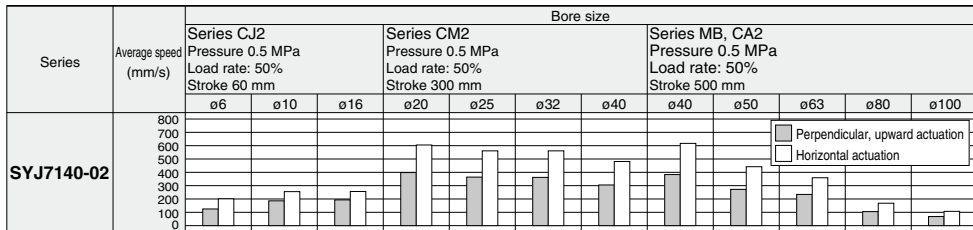

* Cylinder is in extending. Speed controller is meter-out, which is directly connected with cylinder and its needle is fully opened.

* Average speed of cylinder is obtained by dividing the full stroke time by the stroke.

* Load factor: ((Load weight x 9.8) / Theoretical force) x 100%

Conditions

	Body ported	Series CJ2	Series CM2	Series MB/CA2
SYJ7120-01	Tubing bore x Length	ø6 x 1 m		ø12 x 1 m
	Speed controller	AS2302F-06	AS3302F-06	AS4002F-12
	Silencer	AN110-01		AN20-02

	Base mounted	Series CJ2	Series CM2	Series MB/CA2
SYJ7140-02	Tubing bore x Length	ø6 x 1 m		
	Speed controller	AS1302F-06	AS3002F-06	
	Silencer	AN110-01	AN20-02	AN3301F-06

How to Order

Note) AC-type models that are CE-compliant have DIN terminals only.

Type of actuation

1	2 position single solenoid
2	2 position double solenoid
3	3 position closed center
4	3 position exhaust center
5	3 position pressure center

Light/Surge voltage suppressor

Electrical entry for G, H, L, M, W

NiI	Without light/surge voltage suppressor
S	With surge voltage suppressor
Z	With light/surge voltage suppressor
R	With surge voltage suppressor (Non-polar type)
U	With light/surge voltage suppressor (Non-polar type)

* For AC voltage valves there is no "S" option. It is already built-in to the rectifier circuit.
 * For type "R" and "U", DC voltage is only available.
 * Power saving circuit is only available in the "Z" type.

Electrical entry for D, Y

NiI	Without light/surge voltage suppressor
S	With surge voltage suppressor (Non-polar type)
Z	With light/surge voltage suppressor (Non-polar type)

* DOZ and YOZ are not available.
 * For AC voltage valves there is no "S" option. It is already built-in to the rectifier circuit.

Bracket

NiI	Without bracket
F	With bracket

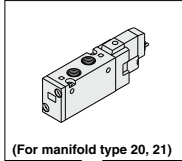

Body ported

Base mounted

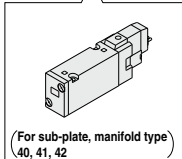

Rated voltage

DC	AC (50/60 Hz)
5	1
6	2
V	3
S	4
R	

24 VDC, 12 VDC, 6 VDC, 5 VDC, 3 VDC
 100 VAC, 200 VAC, 110 VAC [115 VAC], 220 VAC [230 VAC]

* DC specifications of type D, Y, DO and YO are only available with 12 and 24 VDC.
 * For type W□, DC voltage is only available.
 Note) AC-type models that are CE-compliant have DIN terminals only.

Thread type

NiI	Rc
F	G
N	NPT
T	NPTF

A, B port size

01	1/8
C6	One-touch fitting for ø6
C8	One-touch fitting for ø8
N7	One-touch fitting for ø1/4"
N9	One-touch fitting for ø5/16"

Note) Do not remove the factory installed bracket from models with the bracket option. Removal of the bracket will cause the valve to leak. Brackets cannot be retrofitted.
 * 2 position single type only.

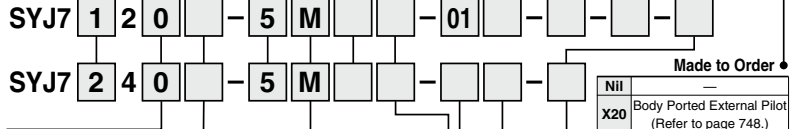

Coil specifications

NiI	Standard
T	With power saving circuit <24, 12 VDC only>

* Power saving circuit is not available in the case of D, Y, DO, YO or W□ type.

Thread type

NiI	Rc
F	G
N	NPT
T	NPTF

CE-compliant

NiI	—
Q	CE-compliant

Note) AC-type models that are CE compliant have DIN terminals only.

Manual override

NiI	Non-locking push type
-----	-----------------------

Port size

NiI	Without sub-plate
-----	-------------------

Electrical entry

Grommet	24, 12, 6, 5, 3 VDC 100, 110, 200, 220 VAC			24, 12 VDC 100, 110, 200, 220 VAC		24, 12, 6, 5, 3 VDC	
	L plug connector (Length 300 mm)	M plug connector (Length 300 mm)	MN: Without lead wire	DIN terminal	M8 connector	DO, YO: Without connector	W□: With connector cable (Note 1)
G: Lead wire length 300 mm	L: With lead wire (Length 300 mm)	M: With lead wire (Length 300 mm)	MN: Without lead wire	D, Y: With connector	WO: Without connector cable	DO, YO: Without connector	W□: With connector cable (Note 1)
H: Lead wire length 600 mm	LN: Without lead wire	LO: Without connector	MO: Without connector				
CE compliant	DC	AC					

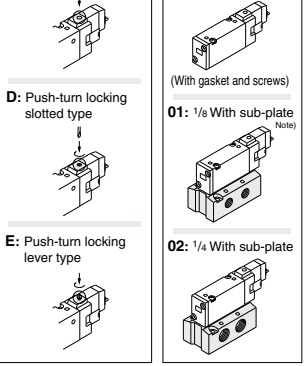

* LN, MN type: with 2 sockets.
 * Refer to page 751 for the lead wire length of L and M plug connectors.
 * Refer to page 754 for the connector assembly with cover for L and M plug connectors.
 * DIN terminal type "Y" which conforms to EN-175301-803C (former DIN43650C) is also available. For details, refer to page 753.
 * For connector cable of M8 connector, refer to page 754.
 * M8 thread conforming to IEC60947-5-2 standard is also available. Refer to page 749 for details.

Note) When placing an order for body ported solenoid valve as a single unit, mounting screws for manifold and gasket are not attached. Order them separately, if necessary. (For details, refer to page 738.)

Construction

2 position single

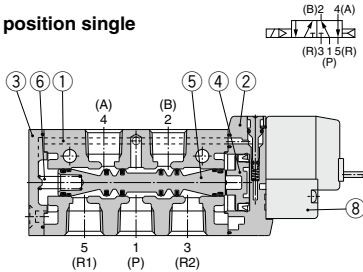

2 position double

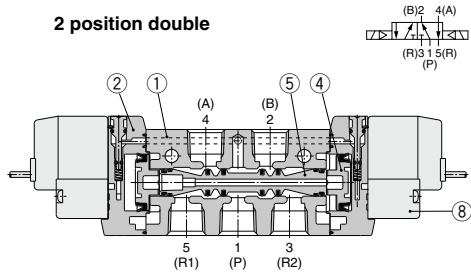

3 position closed center/exhaust center/pressure center

3 position closed center

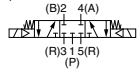

3 position exhaust center

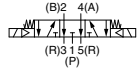

3 position pressure center

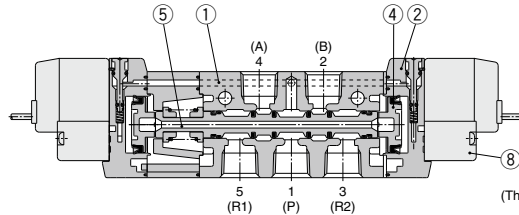

(This figure shows a closed center type.)

Component Parts

No.	Description	Material	Note
1	Body	Aluminum die-casted	White
2	Piston plate	Resin	White
3	End cover	Aluminum die-casted	White
4	Piston	Resin	—
5	Spool valve assembly	Aluminum, H-NBR	—
6	Spool spring	Stainless steel	—

Replacement Parts

No.	Description	Part no.	Note
7	Sub-plate ^(Note)	SYJ7000-22-1(-Q) SYJ7000-22-2(-Q)	1/8 1/4 Aluminum die-casted
8	Pilot valve	V111(T)-□□□□	—

Note) Add suffix "-Q" for the CE-compliant product.

How to Order Pilot Valve Assembly

V111 □ - 5 G □

Coil specifications

Nii	Standard
T	With power saving circuit (24, 12 VDC only)

* Power saving circuit is not available in the case of W□ type.

Rated voltage

5	24 VDC
6	12 VDC
V	6 VDC
S	5 VDC
R	3 VDC
1	100 VAC 50/60 Hz
2	200 VAC 50/60 Hz
3	110 VAC 50/60 Hz [115 VAC 50/60 Hz]
4	220 VAC 50/60 Hz [230 VAC 50/60 Hz]

* For type W□, DC voltage is only available.

* CE-compliant: For DC only.

Light/Surge voltage suppressor

Nii	Without light/surge voltage suppressor
S	With surge voltage suppressor
Z	With light/surge voltage suppressor
R	With surge voltage suppressor (Non-polar type)
U	With light/surge voltage suppressor (Non-polar type)

* For AC voltage valves there is no "S" option. It is already built-in to the rectifier circuit.

* For type R and U, DC voltage is only available.

* Power saving circuit is only available in the "Z" type.

Electrical entry

G	Grommet, 300 mm lead wire	
H	Grommet, 600 mm lead wire	
L	L plug connector	With lead wire
LN	Without lead wire	
LO	Without connector	
M	M plug connector	With lead wire
MN	Without lead wire	
MO	Without connector	
WO	M8 Without connector cable	
W□	connector With connector cable ^{Note 1)}	

* For connector cable of M8 connector, refer to page 754.

V115 - 5 D □

Rated voltage

5	24 VDC
6	12 VDC
1	100 VAC 50/60 Hz
2	200 VAC 50/60 Hz
3	110 VAC 50/60 Hz [115 VAC 50/60 Hz]
4	220 VAC 50/60 Hz [230 VAC 50/60 Hz]

Light/Surge voltage suppressor

Nii	Without light/surge voltage suppressor
S	With surge voltage suppressor (Non-polar type)
Z	With light/surge voltage suppressor (Non-polar type)

* DOZ is not available.

* For AC voltage valves there is no "S" option. It is already built-in to the rectifier circuit.

Electrical entry

D	DIN terminal	With connector
DO	(Type D)	Without connector
Y	DIN terminal	With connector
YO	(Type Y)	Without connector

Note) Do not replace V111 (G, H, L, M, W) to V115 (DIN terminal) and vice versa when replacing pilot valve assembly only.

Note 1) Enter the cable length symbols in □. Please be sure to fill in the blank referring to page 754.

Note) Since V111 and V115 are CE-compliant as standard, the suffix "-Q" is not necessary.

Series SYJ7000

2 Position Single

* []: AC

Grommet (G), (H): SYJ7120-□□□□-01□□

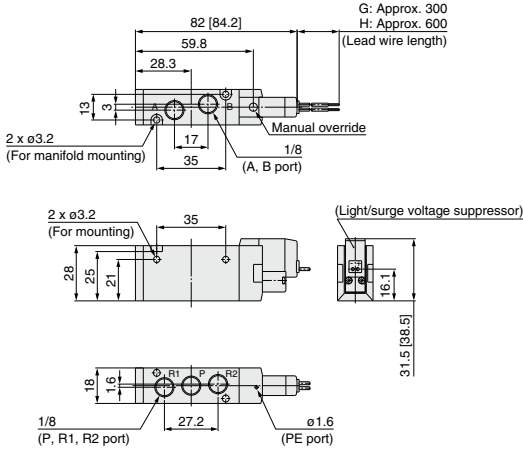

With bracket:
SYJ7120-□□□□-01□□-F

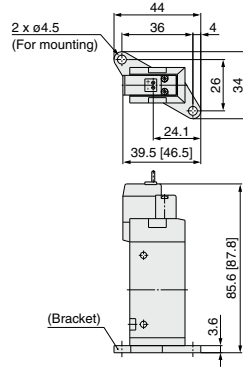

Built-in One-touch fitting:
SYJ7120-□□□□-C₆, N₇-C₈, N₉□□ (-F)

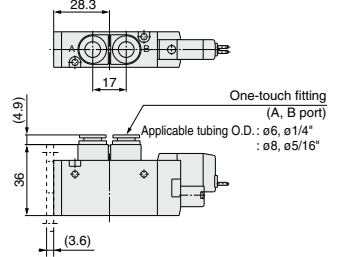

L plug connector (L):
SYJ7120-□□□□-01□□ (-F)

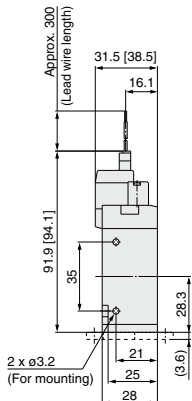

M plug connector (M):
SYJ7120-□□□□-01□□ (-F)

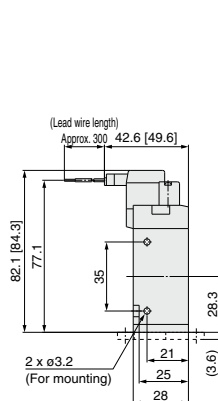

DIN terminal (D, Y):
SYJ7120-□□□□-01□□ (-F)

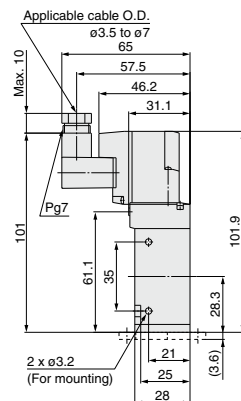

M8 connector (WO):
SYJ7120-□□□□-01□□ (-F)

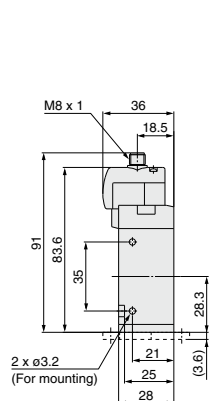

* Refer to page 755 for dimensions with connector cable.

2 Position Double

* [] : AC

Grommet (G), (H): SYJ7220-□□□□-01□

Built-in One-touch fitting:
SYJ7220-□□□□-□□□□
C6, N7
C8, N9 □

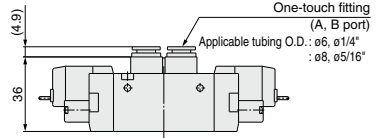
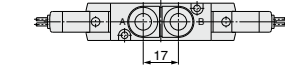
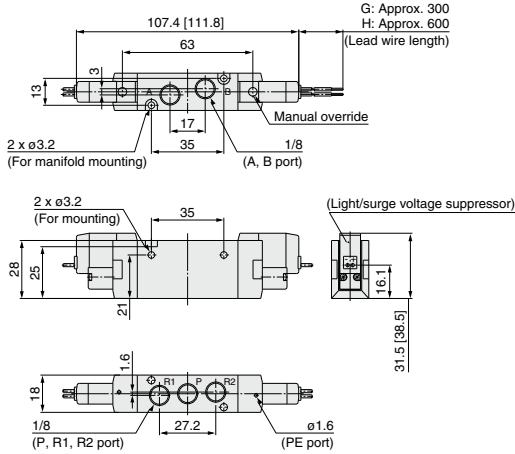

L plug connector (L):
SYJ7220-□□□□-01□

M plug connector (M):
SYJ7220-□□□□-01□

DIN terminal (D, Y):
SYJ7220-□□□□-01□

M8 connector (WO):
SYJ7220-□□□□-01□

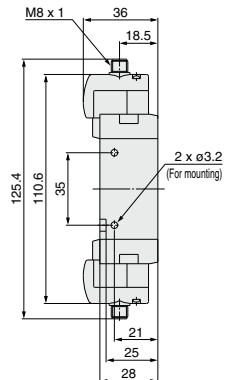
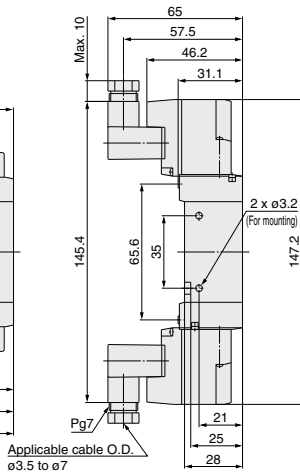
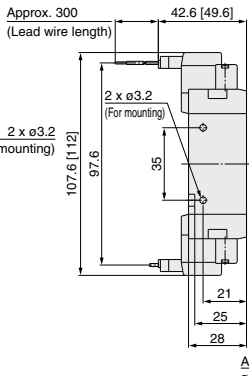
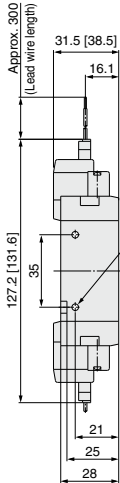

* Refer to page 755 for dimensions with connector cable.

SJ
SY
SY
SV
SYJ
SZ
VF
VP4
S0700
VQ
VQ4
VQ5
VQC
VQC4
VQZ
SQ
VFS
VFR
VQ7

Series SYJ7000

3 Position Closed Center/Exhaust Center/Pressure Center

* []: AC

Grommet (G), (H): SYJ7 $\frac{3}{8}$ 20-□ $\frac{G}{H}$ □□-01□

Built-in One-touch fitting:
SYJ7 $\frac{3}{8}$ 20-□ $\frac{G}{H}$ □□-□ $\frac{C6, N7}{C8, N9}$ □

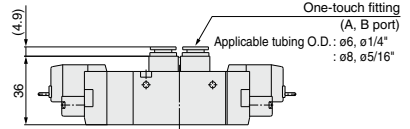
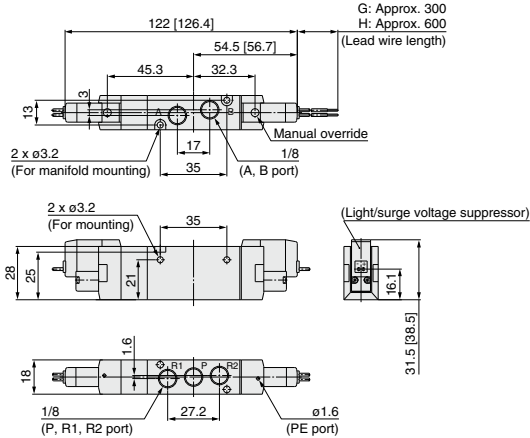

L plug connector (L):
SYJ7 $\frac{3}{8}$ 20-□L□□-01□

M plug connector (M):
SYJ7 $\frac{3}{8}$ 20-□M□□-01□

DIN terminal (D, Y):
SYJ7 $\frac{3}{8}$ 20-□ $\frac{D}{Y}$ □□-01□

M8 connector (WO):
SYJ7 $\frac{3}{8}$ 20-□WO□□-01□

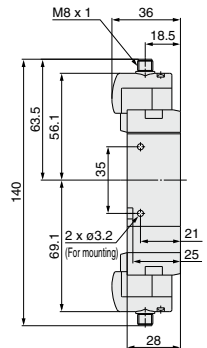
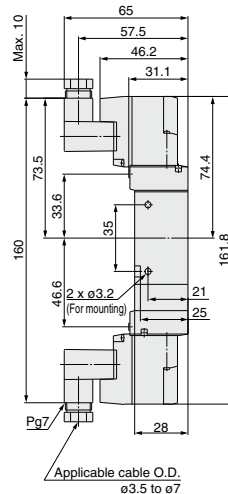
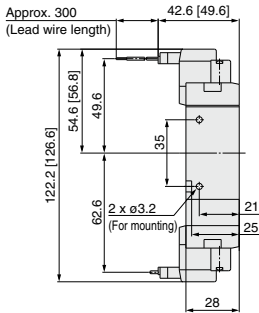
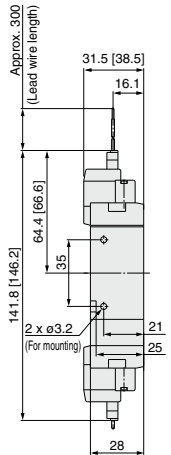

* Refer to page 755 for dimensions with connector cable.

2 Position Single

* []: AC

Grommet (G), (H): SYJ7140-□^G□□-01□□

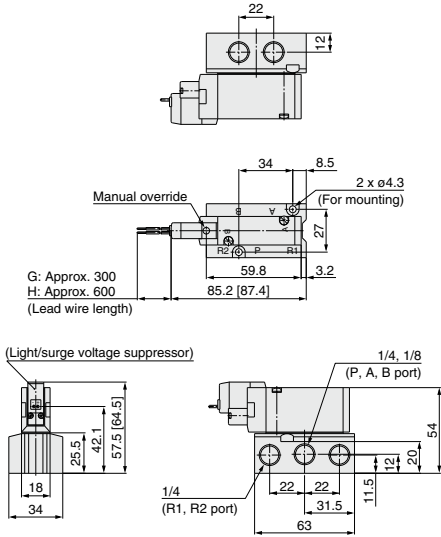

With interface regulator

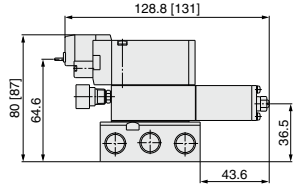

L plug connector (L):
SYJ7140-□L□□-02□□

M plug connector (M):
SYJ7140-□M□□-02□□

DIN terminal (D, Y):
SYJ7140-□^D□□-02□□

M8 connector (WO):
SYJ7140-□WO□□-02□□

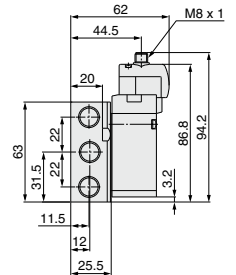
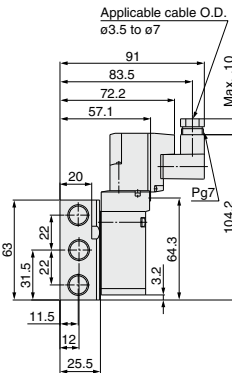
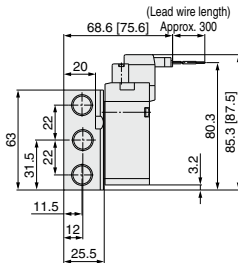
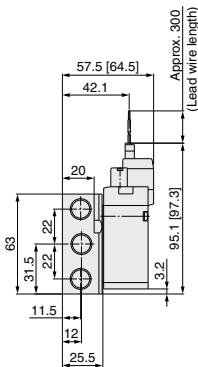

* Refer to page 755 for dimensions with connector cable.

SJ
SY
SY
SV
SYJ
SZ
VF
VP4
S0700
VQ
VQ4
VQ5
VQC
VQC4
VQZ
SQ
VFS
VFR
VQ7

Series SYJ7000

2 Position Double

* []: AC

Grommet (G), (H): SYJ7240-□□□□-01-02□

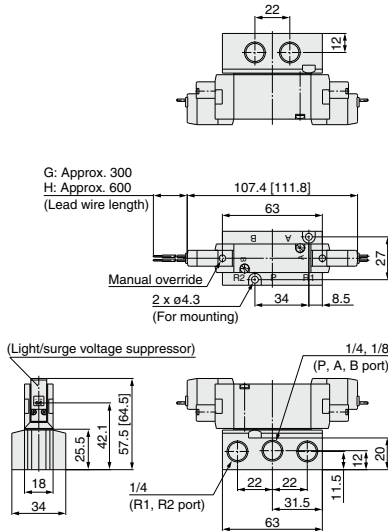

With interface regulator

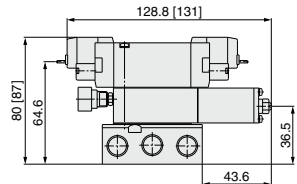

L plug connector (L): SYJ7240-□L□□□□-01-02□

M plug connector (M): SYJ7240-□M□□□□-01-02□

DIN terminal (D, Y): SYJ7240-□□□□-01-02□

M8 connector (WO): SYJ7240-□WO□□□□-01-02□

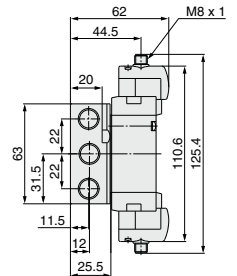
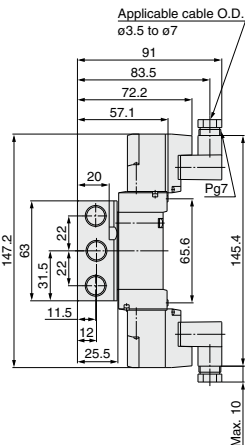
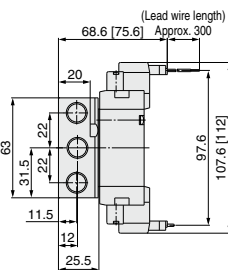
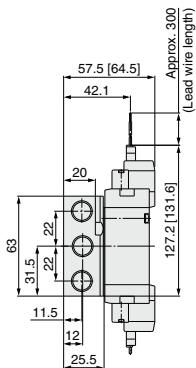

* Refer to page 755 for dimensions with connector cable.

3 Position Closed Center/Exhaust Center/Pressure Center

* []: AC

Grommet (G), (H): SYJ7₃⁴40-□□□□-01□□

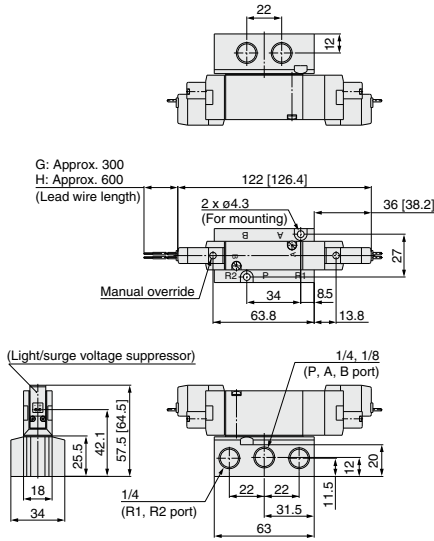

With interface regulator

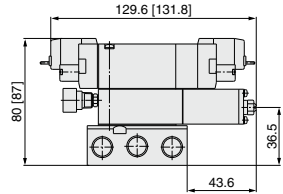

L plug connector (L):
SYJ7₃⁴40-□□□□-01□□

M plug connector (M):
SYJ7₃⁴40-□□□□-01□□

DIN terminal (D, Y):
SYJ7₃⁴40-□□□□-01□□

M8 connector (WO):
SYJ7₃⁴40-□□□□-01□□

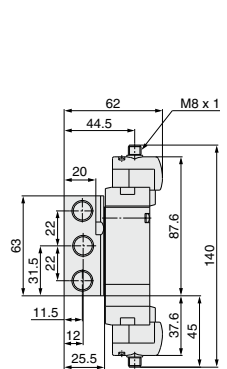
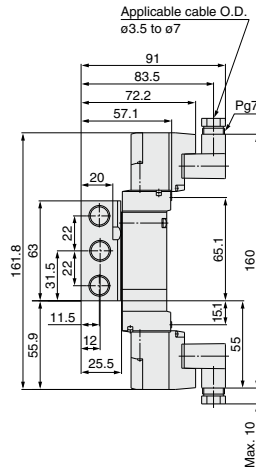
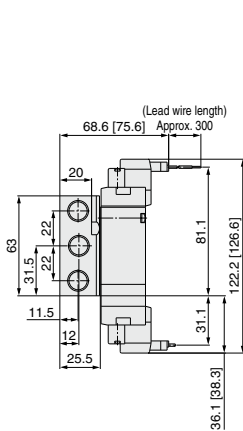
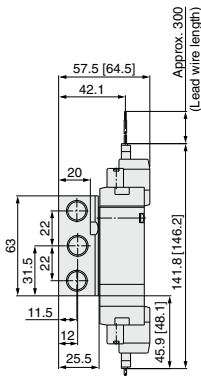

* Refer to page 755 for dimensions with connector cable.

SJ
SY
SV
SYJ
SZ
VF
VP4
S0700
VQ
VQ4
VQ5
VQC
VQC4
VQZ
SQ
VFS
VFR
VQ7

Manifold Standard



Manifold Specifications

Model		Type 20	Type 21	Type 40	Type 41	Type 42
Manifold type		Single base/B mount				
P (SUP), R (EXH)		Common SUP, Common EXH				
Valve stations		2 to 15 stations		2 to 20 stations		
A, B port	Location	Valve		Base	Base	
	Direction	Top		Bottom	Side	
Porting specifications		P, R port		1/8		
Port size	A, B port	1/8		1/8		C6 (One-touch fitting for ø6) C8 (One-touch fitting for ø8)
		C6 (One-touch fitting for ø6) C8 (One-touch fitting for ø8)		1/8		

Flow Characteristics

Manifold			Port size		Flow characteristics							
					1→4/2 (P→A/B)			4/2→5/3 (A/B→R)				
			1(P), 5(R) Port	2(B), 4(A) Port	C [dm ³ /(s·bar)]	b	Cv	C [dm ³ /(s·bar)]	b	Cv		
Body ported for internal pilot	Type SSSYJ7-20	SYJ7□2□	1/8	1/8	2.2	0.35	0.57	2.3	0.26	0.55		
			1/8	C6	1.4	0.32	0.37	2.0	0.25	0.49		
			1/8	C8	1.7	0.38	0.45	2.1	0.25	0.51		
	Type SSSYJ7-21		1/4	1/8	2.1	0.36	0.55	2.3	0.26	0.54		
			1/4	C6	1.4	0.32	0.36	2.1	0.24	0.50		
			1/4	C8	1.8	0.37	0.50	2.1	0.20	0.50		
Base mounted for internal pilot	Type SSSYJ7-40	SYJ7□4□	1/4	1/8	2.1	0.28	0.51	2.5	0.23	0.59		
			1/4	1/8	2.0	0.30	0.50	2.2	0.30	0.55		
			1/4	C6	1.5	0.32	0.38	2.2	0.23	0.52		
	Type SSSYJ7-41		SYJ7□4□	1/4	C6	1.5	0.32	0.38	2.2	0.23	0.52	
				Type SSSYJ7-42-C6	1/4	C8	1.9	0.24	0.46	2.2	0.26	0.53
					Type SSSYJ7-42-C8	1/4	C8	1.9	0.24	0.46	2.2	0.26

Note) Value at manifold base mounted, 2 position single operating

How to Order Manifold (Example)

Instruct by specifying the valves and blanking plate assembly to be mounted on the manifold along with the manifold base model no.

Example: ●SS5YJ7-20-03 1 pc. (Manifold base)
 *SYJ7120-5G-01 2 pcs. (Valve)
 *SYJ7000-21-1A 1 pc. (Blanking plate assembly)

●SS5YJ7-41-03-01 1 pc. (Manifold base)
 *SYJ7140-5LZ 1 pc. (Valve)
 *SYJ7240-5LZ 1 pc. (Valve)
 *SYJ7000-21-1A 1 pc. (Blanking plate assembly)

↳The asterisk denotes the symbol for assembly. Prefix it to the part nos. of the solenoid valve, etc.



Note) CE-compliant:
For DC only.

[Option]

Flat Ribbon Cable Manifold

- Multiple valve wiring is simplified through the use of the flat cable connector.
- Clean appearance

In the case of a flat ribbon cable type, each valve is wired on the print board of manifold base to allow the external wiring to be piped all together with 26 pins MIL connector.



Flat Ribbon Cable Manifold Specifications

Model		Type 21P
Manifold type		Single base/B mount
P (SUP), R (EXH)		Common SUP, Common EXH
Valve stations		3 to 12 stations
A, B port location		Valve
Port size	P, R port	1/4
	A, B port	1/8, C6, C8
Applicable flat ribbon cable connector		Socket: 26 pins MIL type with strain relief (MIL-C-83503)
Internal wiring		In common between +COM and -COM (Z type: +COM only).
Rated voltage (Note 3)		24, 12 VDC, 100, 110 VAC

Note 1) The value is for manifold base and individually operated 2 position type.

Note 2) The withstand voltage specification for the wiring unit section is JIS C 0704, Grade 1 or its equivalent.

Note 3) CE-compliant: For DC only.

Flow Characteristics

Manifold		Port size		Flow characteristics					
				1→4/2 (P→A/B)			4/2→5/3 (A/B→R)		
				C	b	Cv	C	b	Cv
Body ported for internal pilot	Type S5VJ7-21P-01	1(P), 5/3(R) Port	2(B), 4(A) Port	C [dm ³ /(s·bar)]	b	Cv	C [dm ³ /(s·bar)]	b	Cv
	Type S5VJ7-21P-C6	1/4	1/8	2.1	0.36	0.55	2.3	0.26	0.54
	Type S5VJ7-21P-C8	1/4	C6	1.4	0.32	0.36	2.1	0.24	0.50
	Type S5VJ7-21P-C8	1/4	C8	1.8	0.37	0.50	2.1	0.20	0.50

Note) Value at manifold base mounted, 2 position single operating

How to Order Manifold (Example)

Instruct by specifying the valves, blanking plate assembly and connector assembly to be mounted on the manifold along with the manifold base model no.

Example:

- S5VJ7-21P-07 (-Q) 1 pc. (Manifold base)
 - * SYJ7123-5LOU-C8 (-Q) ... 3 pcs. (Valve)
 - * SYJ7223-5LOU-C8 (-Q) ... 3 pcs. (Valve)
 - * SYJ7000-21-3A (-Q) 1 pc. (Blanking plate assembly)
 - * SY3000-37-3A 3 pcs. (Connector assembly)
 - * SY3000-37-4A 3 pcs. (Connector assembly)
- The asterisk denotes the symbol for assembly. Prefix it to the part nos. of the solenoid valve, etc.

Note) Please indicate the connector assembly part no. below that connects the valve and the manifold.

How to Order Valve

Note) CE-compliant:
For DC only.



[Option]

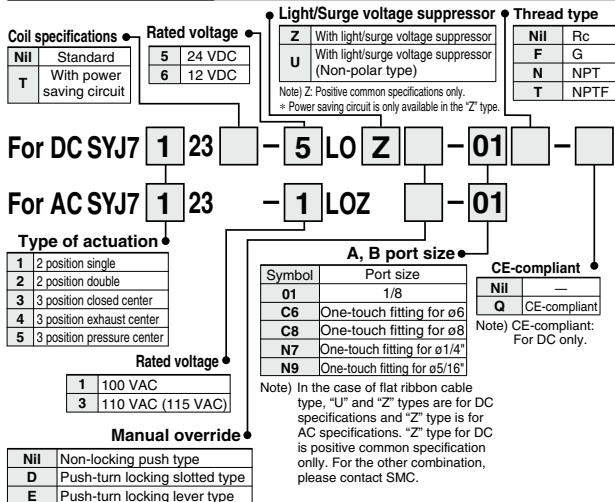

Connector Assembly

For 12, 24 VDC

Single solenoid	SY3000-37-3A
Double solenoid, 3 position type	SY3000-37-4A
Single solenoid	SY3000-37-3A
With individual EXH spacer assembly	SY3000-37-6A
Double solenoid, 3 position type	SY3000-37-3A
With individual EXH spacer assembly	SY3000-37-3A
With 3 port adaptor plate	SY3000-37-3A

For 100 VAC

Single solenoid	SY3000-37-32A
Double solenoid, 3 position type	SY3000-37-33A
Single solenoid	SY3000-37-15A
With individual EXH spacer assembly	SY3000-37-34A
Double solenoid, 3 position type	SY3000-37-34A
With individual EXH spacer assembly	SY3000-37-32A
With 3 port adaptor plate	SY3000-37-32A

For 110 VAC

Single solenoid	SY3000-37-35A
Double solenoid, 3 position type	SY3000-37-36A
Single solenoid	SY3000-37-19A
With individual EXH spacer assembly	SY3000-37-37A
Double solenoid, 3 position type	SY3000-37-37A
With individual EXH spacer assembly	SY3000-37-35A
With 3 port adaptor plate	SY3000-37-35A

SJ
SY
SY
SV
SYJ
SZ
VF
VP4
S0700
VQ
VQ4
VQ5
VQC
VQC4
VQZ
SQ
VFS
VFR
VQ7

Series SYJ7000

EX510 Gateway-type Serial Transmission System

Manifold for EX510 Serial Wiring Specifications

Model	Type 21SA	Type 41SA
Manifold type	Single base/B mount	
P (SUP), R (EXH)	Common SUP, Common EXH	
Valve stations	3 to 16 stations	
A, B port Porting specifications	Location	Valve
	Direction	Top
Port size	P, R port	1/4
	A, B port	1/8, C6, C8 (One-touch fitting for $\phi 6, \phi 8$)
Rated voltage	24 VDC	

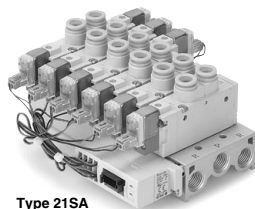

Type 21SA

Flow Characteristics

Manifold			Port size		Flow characteristics					
					1→4/2 (P→A/B)			4/2→5/3 (A/B→R)		
			1(P), 5/3(R) Port	2(B), 4(A) Port	C [dm ³ /(s·bar)]	b	Cv	C [dm ³ /(s·bar)]	b	Cv
Body ported for internal pilot	Type SS5YJ7-21SA	SYJ7□2□	1/4	1/8	2.1	0.36	0.55	2.3	0.26	0.54
			1/4	C6	1.4	0.32	0.36	2.1	0.24	0.50
			1/4	C8	1.8	0.37	0.50	2.1	0.20	0.50
Base mounted for internal pilot	Type SS5YJ7-41SA	SYJ7□4□	1/4	1/8	2.0	0.30	0.50	2.2	0.30	0.55

How to Order Manifold (Example)

SS5YJ7-21SA-05 1 set (Type 21SA 5 stations manifold part no.)

* SYJ7123-5LOU-01 3 sets (Single solenoid part no.)

* SYJ7223-5LOU-01 2 sets (Double solenoid part no.)

↳ The asterisk denotes the symbol for assembly. Prefix it to the part nos. of the solenoid valve, etc.

Add the valve and option part numbers under the manifold base part number. In the case of complex arrangement, specify them on the manifold specification sheet. The connector assembly lead wire length used for EX510 manifold varies depending on the number of stations. Therefore, solenoid valves (including a blanking plate) and connector assembly are assembled when shipped as a standard specification. Please specify the mounting solenoid valve when ordering.

SJ
SY
SY
SV
SYJ
SZ
VF
VP4
S0700
VQ
VQ4
VQ5
VQC
VQC4
VQZ
SQ
VFS
VFR
VQ7

EX510 Gateway-type Serial Transmission System Body Ported Manifold

Series SYJ7000



How to Order Manifold

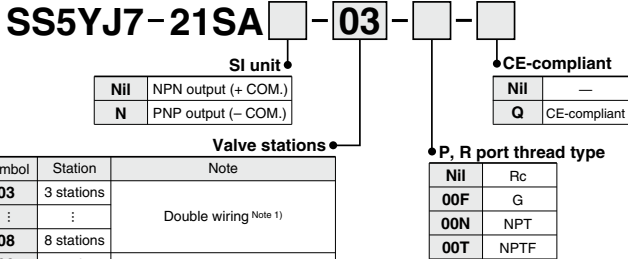

The number of the blanking plate assembly is also included.
 Note 1) Double wiring: Use of a single solenoid will result in an unused control signal. If this is not desired, order with a specified layout.
 Note 2) Specified layout: Indicate wiring specifications on the manifold specification sheet. (Note that double and 3 position valves cannot be used where single solenoid wiring has been specified.)

SI unit part no.

Symbol	SI unit specifications	SI unit part no.	Page
Nil	NPN output (+ COM.)	EX510-S001	P.2143
N	PNP output (- COM.)	EX510-S101	

Refer to page 2124 and the Operation Manual for the details of EX510 Gateway-type Serial Transmission System. Please download the Operation Manual via our website, <http://www.smcworld.com>

How to Order Valve



Type of actuation

1	2 position single
2	2 position double
3	3 position closed center
4	3 position exhaust center
5	3 position pressure center

Coil specifications

Nil	Standard
T	With power saving circuit

Rated voltage: 24 VDC

Light/Surge voltage suppressor

Z	With light/surge voltage suppressor
U	Without light/surge voltage suppressor (non-polar type)

* Power saving circuit is only available in the "Z" type.

Manual override

Nil	Non-locking push type
D	Push-turn locking slotted type
E	Push-turn locking lever type

A, B port size

01	1/8
C6	One-touch fitting for ø6
C8	One-touch fitting for ø8
N7	One-touch fitting for ø1/4"
N9	One-touch fitting for ø5/16"

Thread type

Nil	Rc
F	G
N	NPT
T	NPTF

CE-compliant

Nil	—
Q	CE-compliant

How to Order Manifold Assembly (Example)

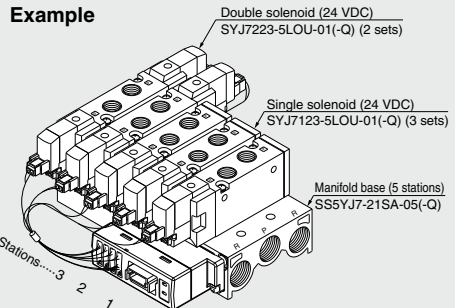

SS5YJ7-21SA-05 (-Q) 1 set (Type 21SA 5-station manifold part no.)
*** SYJ7123-5LOU-01 (-Q) ... 3 sets (Single solenoid part no.)**
*** SYJ7223-5LOU-01 (-Q) ... 2 sets (Double solenoid part no.)**
 The asterisk denotes the symbol for assembly. Prefix it to the part nos. of the solenoid valve, etc.

Add the valve and option part numbers under the manifold base part number. In the case of complex arrangement, specify them on the manifold specification sheet. The connector assembly lead wire length used for EX510 manifold varies depending on the number of stations. Therefore, solenoid valves (including a blanking plate) and connector assembly are assembled when shipped as a standard specification. Please specify the mounting solenoid valve when ordering.

EX510 Gateway-type Serial Transmission System Base Mounted Manifold

Series SYJ7000



How to Order Manifold

SS5YJ7-41SA [] - 03 - 01 [] - []

SI unit

Nil	NPN output (+ COM.)
N	PNP output (- COM.)

CE-compliant

Nil	—
Q	CE-compliant

P, R, A, B port thread type

Nil	Rc
F	G
N	NPT
T	NPTF

A, B port size

01	1/8
----	-----

Valve stations

Symbol	Station	Note
03	3 stations	Double wiring (Note 1)
:	:	
08	8 stations	Specified layout (Note 2) (Up to 16 solenoids)
03	3 stations	
:	:	
16	16 stations	

- The number of the blanking plate assembly is also included.
- Note 1) Double wiring: Use of a single solenoid will result in an unused control signal. If this is not desired, order with a specified layout.
- Note 2) Specified layout: Indicate wiring specifications on the manifold specification sheet. (Note that double and 3 position valves cannot be used where single solenoid wiring has been specified.)

SI unit part no.

Symbol	SI unit specifications	SI unit part no.	Page
Nil	NPN output (+ COM.)	EX510-S001	P.2143
N	PNP output (- COM.)	EX510-S101	

Refer to page 2124 and the Operation Manual for the details of EX510 Gateway-type Serial Transmission System. Please download the Operation Manual via our website, <http://www.smcworld.com>

How to Order Valve

SYJ7 [] 1 43 [] - 5LO [] Z [] - []

Type of actuation

1	2 position single
2	2 position double
3	3 position closed center
4	3 position exhaust center
5	3 position pressure center

Coil specifications

Nil	Standard
T	With power saving circuit

Rated voltage: 24 VDC

Light/Surge voltage suppressor

Z	With light/surge voltage suppressor
U	Without light/surge voltage suppressor (non-polar type)

* Power saving circuit is only available in the "Z" type.

Manual override

Nil	Non-locking push type
D	Push-turn locking slotted type
E	Push-turn locking lever type

CE-compliant

Nil	—
Q	CE-compliant

How to Order Manifold Assembly (Example)

Example

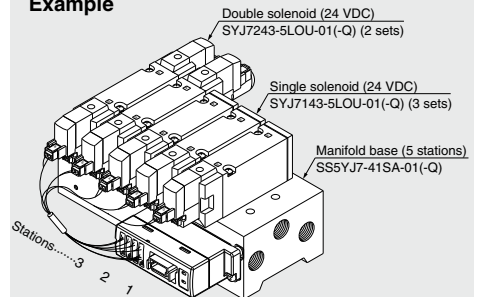

SS5YJ7-41SA-05 (-Q) 1 set (Type 41SA 5-station manifold part no.)
 * SYJ7143-5LOU-01 (-Q) ... 3 sets (5-station manifold part no.)
 * SYJ7243-5LOU-01 (-Q) ... 2 sets (Double solenoid part no.)
 The asterisk denotes the symbol for assembly. Prefix it to the part nos. of the solenoid valve, etc.

Add the valve and option part numbers under the manifold base part number. In the case of complex arrangement, specify them on the manifold specification sheet. The connector assembly lead wire length used for EX510 manifold varies depending on the number of stations. Therefore, solenoid valves (including a blanking plate) and connector assembly are assembled when shipped as a standard specification. Please specify the mounting solenoid valve when ordering.

SJ
SY
SY
SV
SYJ
SZ
VF
VP4
S0700
VQ
VQ4
VQ5
VQC
VQC4
VQZ
SQ
VFS
VFR
VQ7

Manifold Standard

Note) AC-type models that are CE-compliant have DIN terminals only.



Common SUP/Common EXH

Type 20 (5 port/Body ported)

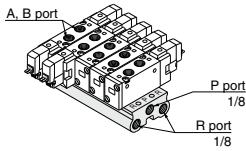

How to Order

SS5YJ7-20-05 - [] - [] - []

Stations	
02	2 stations
:	:
15	15 stations

P, R port thread type	
Nil	Rc
00F	G
00N	NPT
00T	NPTF

CE-compliant	
Nil	—
Q	CE-compliant

Applicable solenoid valve

SYJ□20-□□□□(-Q)
01 C6 N7(-Q)
C8 N9

SYJ□23-□□□□(-Q)
01 C6 N7(-Q)
C8 N9

Note) For more than 6 stations, supply air to both sides of P port and exhaust air from both sides of R port.

Applicable blanking plate assembly
Refer to page 739.

Type 21 (5 port/Body ported)

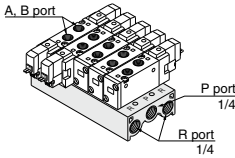

How to Order

SS5YJ7-21-05 - [] - [] - []

Stations	
02	2 stations
:	:
20	15 stations

P, R port thread type	
Nil	Rc
00F	G
00N	NPT
00T	NPTF

CE-compliant	
Nil	—
Q	CE-compliant

Applicable individual EXH spacer assembly
Refer to page 738.

Note) For more than 10 stations, supply air to both sides of P port and exhaust air from both sides of R port.

Type 40 (5 port/Base mounted)

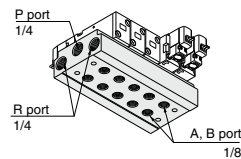

How to Order

SS5YJ7-40-05-01 [] - [] - []

Stations	
02	2 stations
:	:
20	20 stations

A, B port size	
01	1/8

Thread type	
Nil	Rc
F	G
N	NPT
T	NPTF

CE-compliant	
Nil	—
Q	CE-compliant

Note) For more than 10 stations, supply air to both sides of P port and exhaust air from both sides of R port.

Applicable solenoid valve
SYJ□40-□□□□(-Q)
SYJ□43-□□□□(-Q)

Type 41 (5 port/Base mounted)

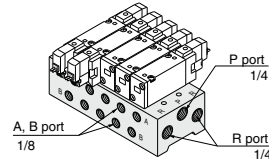

How to Order

SS5YJ7-41-05-01 [] - [] - []

Stations	
02	2 stations
:	:
20	20 stations

Thread type	
Nil	Rc
F	G
N	NPT
T	NPTF

CE-compliant	
Nil	—
Q	CE-compliant

A, B port size	
01	1/8

Note) For more than 8 stations, supply air to both sides of P port and exhaust air from both sides of R port.

Applicable blanking plate assembly
Refer to page 739.

Applicable individual EXH spacer assembly
Refer to page 738.

Type 42 (5 port/Base mounted)

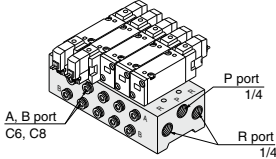

How to Order

SS5YJ7-42-05-C6 [] - [] - []

Stations	
02	2 stations
:	:
20	20 stations

A, B port size	
C6	One-touch fitting for ø6
C8	One-touch fitting for ø8
N7	One-touch fitting for ø1/4"
N9	One-touch fitting for ø5/16"

Thread type	
Nil	Rc
F	G
N	NPT
T	NPTF

CE-compliant	
Nil	—
Q	CE-compliant

Note) For more than 8 stations, supply air to both sides of P port and exhaust air from both sides of R port.

Applicable individual SUP spacer assembly
Refer to page 738.

Applicable interface regulator
Refer to page 738.



Note) CE-compliant:
For DC only. [Option]

Flat Ribbon Cable Manifold

Common SUP/Common EXH

Type 21P (5 Port/Body ported)

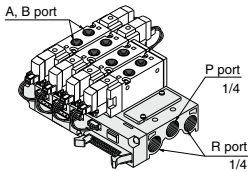

How to Order

SS5YJ7-21P - **05** - **□** - **□**

Stations	
03	3 stations
:	:
12	12 stations

P, R port thread type	
Nil	Rc
00F	G
00N	NPT
00T	NPTF

CE compliant	
Nil	—
Q	CE compliant

Applicable solenoid valve
Refer to page 731.

Applicable blanking plate assembly
Refer to page 739.

Applicable connector assembly
Refer to page 731.

Note) For more than 10 stations, supply air to both sides of P port and exhaust air from both sides of R port.

EX510 Gateway-type Serial Transmission System

Type 21SA (5 Port/Body ported)

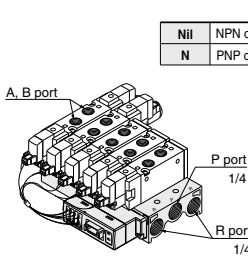

How to Order

SS5YJ7-21SA - **□** - **03** - **□** - **□**

SI unit	
Nil	NPN output (+ COM.)
N	PNP output (- COM.)

Valve stations		
Nil	Station	Note
03	3 stations	Double wiring ^{Note 1)}
:	:	
08	8 stations	Specified layout ^{Note 2)} (Up to 16 solenoids)
03	3 stations	
:	:	
16	16 stations	

CE-compliant	
Nil	—
Q	CE-compliant

P, R port thread type

Nil	Rc
00F	G
00N	NPT
00T	NPTF

Applicable solenoid valve
Refer to page 734.

Applicable blanking plate assembly
Refer to page 739.

The number of the blanking plate assembly is also included.

Note 1) Double wiring: Use of a single solenoid will result in an unused control signal. If this is not desired, order with a specified layout.

Note 2) Specified layout: Indicate wiring specifications on the manifold specification sheet. (Note that double and 3 position valves cannot be used where single solenoid wiring has been specified.)

Type 41SA (5 Port/Base mounted)

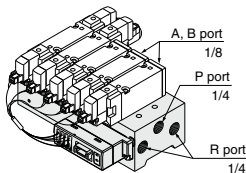

How to Order

SS5YJ7-41SA - **□** - **03** - **01** - **□** - **□**

SI unit	
Nil	NPN output (+ COM.)
N	PNP output (- COM.)

Valve stations		
Nil	Station	Note
03	3 stations	Double wiring ^{Note 1)}
:	:	
08	8 stations	Specified layout ^{Note 2)} (Up to 16 solenoids)
03	3 stations	
:	:	
16	16 stations	

A, B port size
01 1/8

P, R port thread type	
Nil	Rc
F	G
N	NPT
T	NPTF

Applicable solenoid valve
Refer to page 735.

Applicable blanking plate assembly
Refer to page 739.

CE-compliant	
Nil	—
Q	CE-compliant

The number of the blanking plate assembly is also included.

Note 1) Double wiring: Use of a single solenoid will result in an unused control signal. If this is not desired, order with a specified layout.

Note 2) Specified layout: Indicate wiring specifications on the manifold specification sheet. (Note that double and 3 position valves cannot be used where single solenoid wiring has been specified.)

- SJ
- SY
- SY
- SV
- SYJ
- SZ
- VF
- VP4
- S0700
- VQ
- VQ4
- VQ5
- VQC
- VQC4
- VQZ
- SQ
- VFS
- VFR
- VQ7

Series SYJ7000

Combinations of Solenoid Valve, Manifold Gasket and Manifold Base

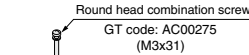
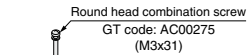

Applicable manifold base

- Type SS5YJ7-20(-Q)
- Type SS5YJ7-21(-Q)
- Type SS5YJ7-21P(-Q)
- Type SS5YJ7-21SA(-Q)

Applicable manifold base

- Sub-plate
- Type SS5YJ7-40(-Q)
- Type SS5YJ7-41(-Q)
- Type SS5YJ7-42(-Q)
- Type SS5YJ7-41SA(-Q)

Individual EXH Spacer Assembly

SYJ7000-17-1 □ A(-Q)

Thread type

NH	Rc
F	G
N	NPT
T	NPTF

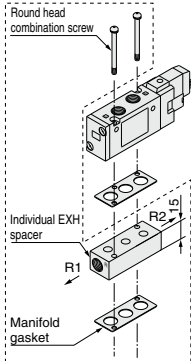

Applicable manifold base

- Type SS5YJ7-20(-Q)
- Type SS5YJ7-21(-Q)
- Type SS5YJ7-21P(-Q)
- Type SS5YJ7-21SA(-Q)

SYJ7000-17-2 □ A(-Q)

Thread type

NH	Rc
F	G
N	NPT
T	NPTF

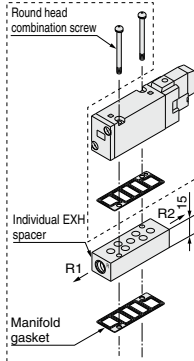

Applicable manifold base

- Type SS5YJ7-40(-Q)
- Type SS5YJ7-41(-Q)
- Type SS5YJ7-42(-Q)
- Type SS5YJ7-41SA(-Q)

Individual SUP Spacer Assembly

SYJ7000-16-2 □ A(-Q)

Thread type

NH	Rc
F	G
N	NPT
T	NPTF

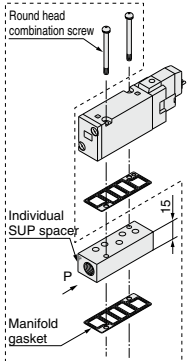

Applicable manifold base

- Type SS5YJ7-40(-Q)
- Type SS5YJ7-41(-Q)
- Type SS5YJ7-42(-Q)
- Type SS5YJ7-41SA(-Q)

Caution

Mounting screw tightening torques

M3: 0.8 N·m

Use caution to the assembly orientation for solenoid valves, gasket, and optional parts.

Interface Regulator (P port regulation)

Spacer type regulating valve on manifold block can regulate the pressure to the valve individually.

ARBYJ7000-00-P(-Q)

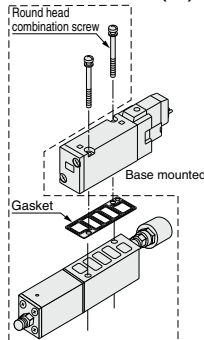

Applicable manifold base

- Type SS5YJ7-40(-Q)
- Type SS5YJ7-41(-Q)
- Type SS5YJ7-42(-Q)

* Refer to page 757 prior to handling.

Mix Installation of the SYJ700 and the SYJ7000 Valves on the Same Manifold

- Use of an adapter plate makes it possible to mount Series SYJ700 on the manifold bases of series SYJ7000.
- When mounting the SYJ700 valve on the SYJ7000 manifold, the SYJ700 solenoid must be positioned on the same side of the manifold as a single solenoid SYJ700. (Refer to the figure below.)
- For base mounted style, the A port of the 3 port valve flows out the B port of manifold base.

Adapter plate assembly SYJ700-3-1A(-Q)

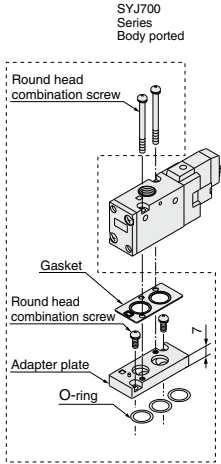

- Applicable manifold base**
- Type SS5YJ7-20(-Q)
 - Type SS5YJ7-21(-Q)
 - Type SS5YJ7-21P(-Q)
 - Type SS5YJ7-21SA(-Q)

Adapter plate assembly SYJ700-3-2A(-Q)

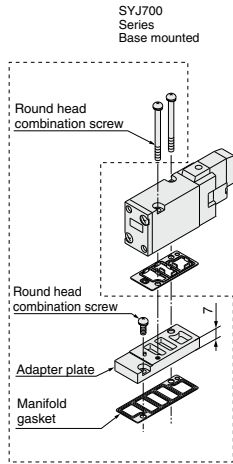

- Applicable manifold base**
- Type SS5YJ7-40(-Q)
 - Type SS5YJ7-41(-Q)
 - Type SS5YJ7-42(-Q)
 - Type SS5YJ7-41SA(-Q)

Blanking Plate Assembly

<Standard> SYJ7000-21-1A

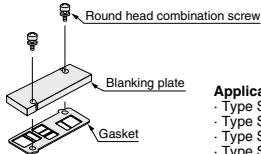

- Applicable manifold base**
- Type SS5YJ7-20
 - Type SS5YJ7-21
 - Type SS5YJ7-41
 - Type SS5YJ7-42
 - Type SS5YJ7-41SA

SYJ7000-21-3A

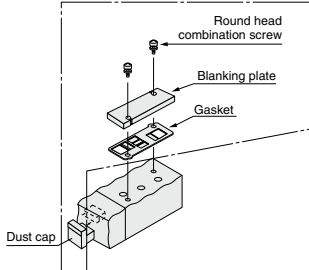

- Applicable manifold base**
- Type SS5YJ7-21P

<CE-compliant> SYJ7000-21-1A-1-Q

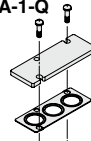

- Applicable manifold base**
- Type SS5YJ7-20-Q
 - Type SS5YJ7-21-Q
 - Type SS5YJ7-21SA-Q

SYJ7000-21-1A-2-Q

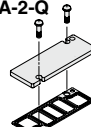

- Applicable manifold base**
- Type SS5YJ7-40-Q
 - Type SS5YJ7-41-Q
 - Type SS5YJ7-42-Q
 - Type SS5YJ7-41SA-Q

SYJ7000-21-3A-Q

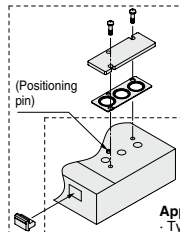

- Applicable manifold base**
- Type SS5YJ7-21P-Q

SJ
SY
SV
SYJ
SZ
VF
VP4
S0700
VQ
VQ4
VQ5
VQC
VQC4
VQZ
SQ
VFS
VFR
VQ7

Series SYJ7000

Type 20: Top Protod/SS5YJ7-20 Stations-00□

* []: AC

Grommet (G)

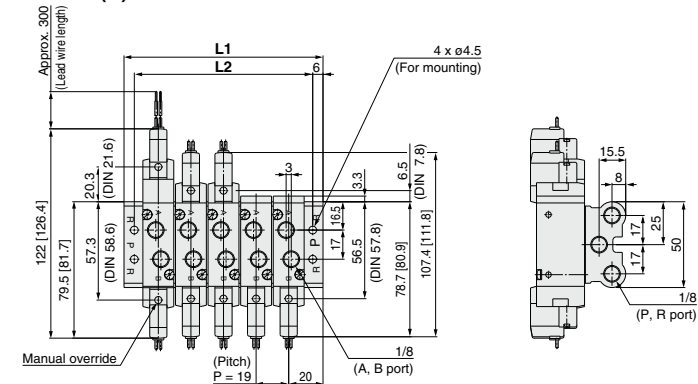

Built-in One-touch fitting

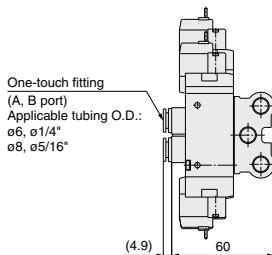
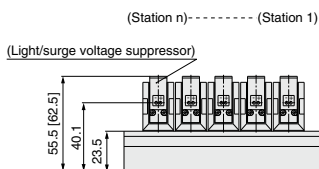

L plug connector (L)

M plug connector (M)

DIN terminal (D, Y)

M8 connector (WO)

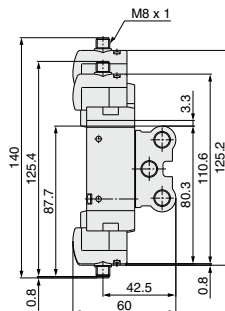
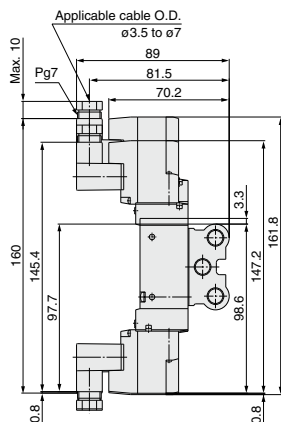
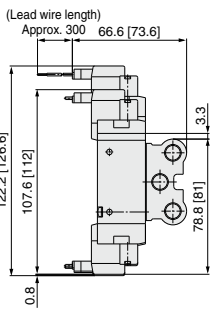
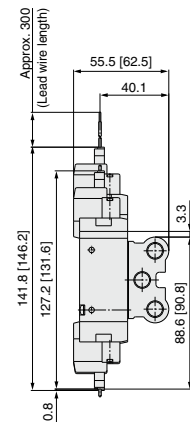

* Refer to page 755 for dimensions with connector cable.

Station n	Station 2	3	4	5	6	7	8	9	10	11	12	13	14	Station 15
L1	59	78	97	116	135	154	173	192	211	230	249	268	287	306
L2	47	66	85	104	123	142	161	180	199	218	237	256	275	294

Type 21: Top Ported/SS5YJ7-21- Stations (-00□)

* [] : AC

Grommet (G)

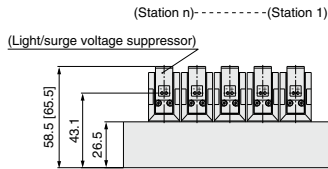
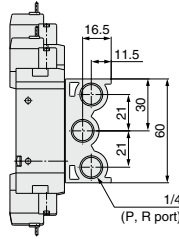
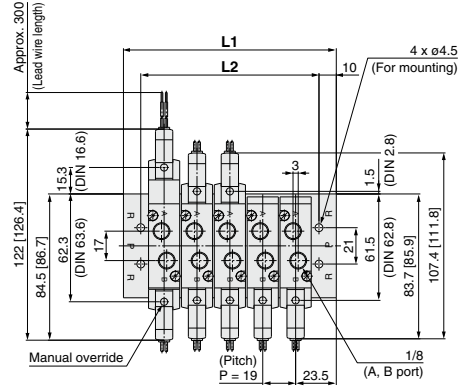

Built-in One-touch fitting

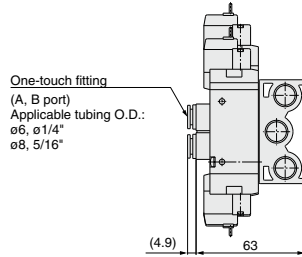

L plug connector (L)

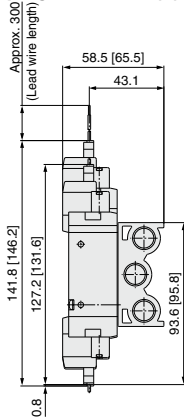

M plug connector (M)

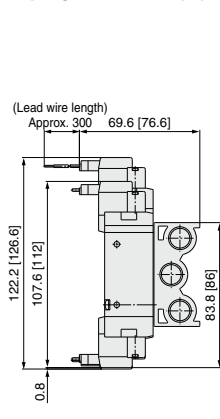

DIN terminal (D, Y)

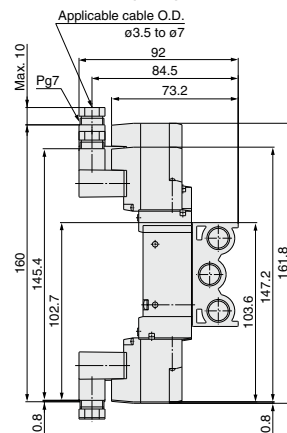

M8 connector (WO)

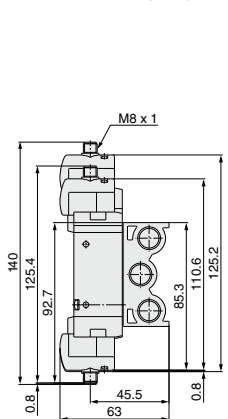

* Refer to page 755 for dimensions with connector cable.

Station n	Station 2	3	4	5	6	7	8	9	10	11	12	13	14	15	16	17	18	19	Station 20
L1	66	85	104	123	142	161	180	199	218	237	256	275	294	313	332	351	370	389	408
L2	46	65	84	103	122	141	160	179	198	217	236	255	274	293	312	331	350	369	388

- SJ
- SY
- SY
- SV
- SYJ**
- SZ
- VF
- VP4
- S0700
- VQ
- VQ4
- VQ5
- VQC
- VQC4
- VQZ
- SQ
- VFS
- VFR
- VQ7

Series SYJ7000

Type 40: Bottom Ported/SS5YJ7-40- Stations -01 □

* []: AC

Grommet (G)

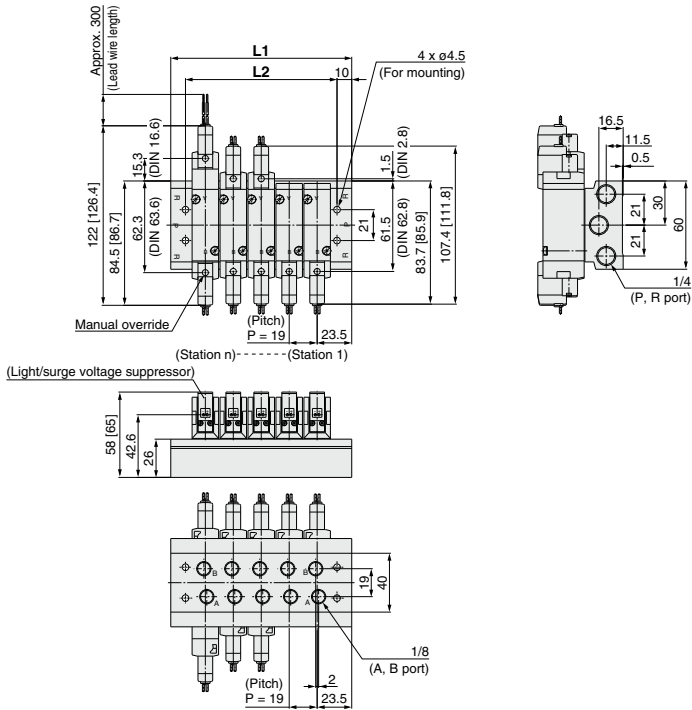

L plug connector (L)

M plug connector (M)

DIN terminal (D, Y)

M8 connector (WO)

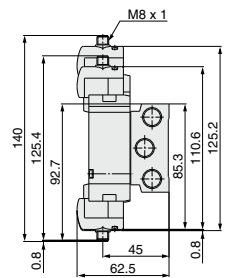
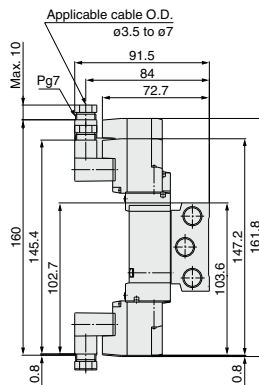
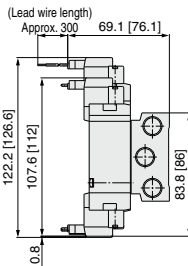
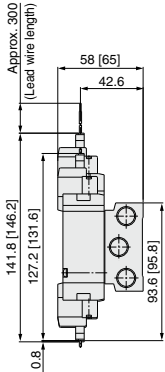

* Refer to page 755 for dimensions with connector cable.

Station n	Station 2	3	4	5	6	7	8	9	10	11	12	13	14	15	16	17	18	19	Station 20
L1	66	85	104	123	142	161	180	199	218	237	256	275	294	313	332	351	370	389	408
L2	46	65	84	103	122	141	160	179	198	217	236	255	274	293	312	331	350	369	388

Type 41: Side Ported/SS5YJ7-41- Stations -01 □

* [] : AC

Grommet (G)

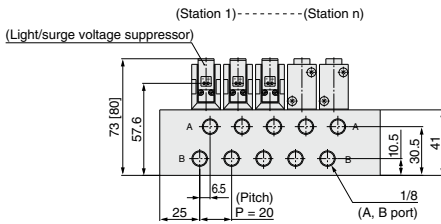
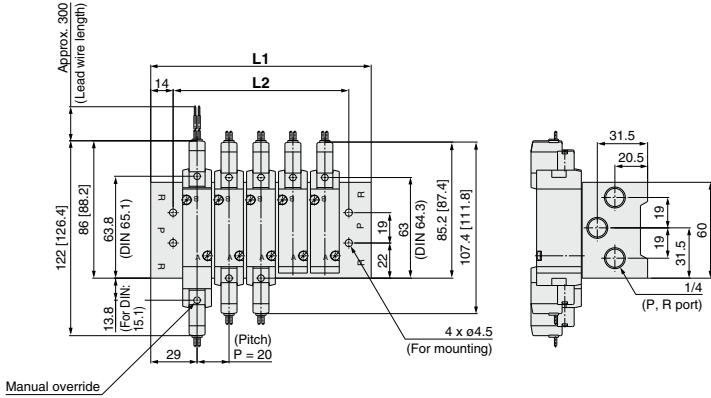

L plug connector (L)

M plug connector (M)

DIN terminal (D, Y)

M8 connector (WO)

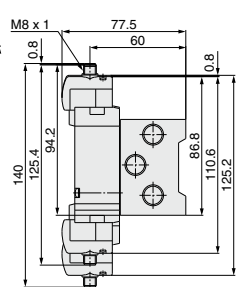
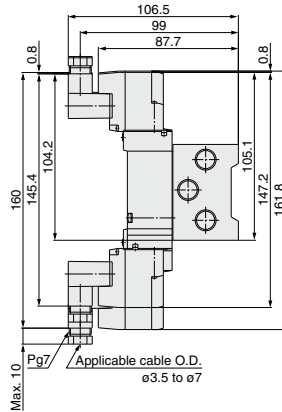
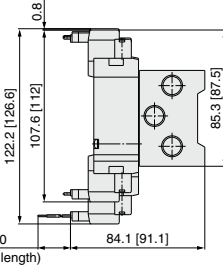
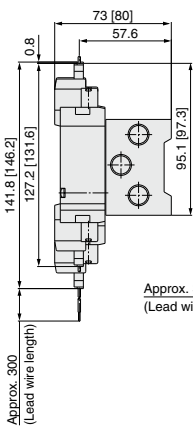

* Refer to 755 for dimensions with connector cable.

Station n	Station 2	3	4	5	6	7	8	9	10	11	12	13	14	15	16	17	18	19	Station 20
L1	78	98	118	138	158	178	198	218	238	258	278	298	318	338	358	378	398	418	438
L2	50	70	90	110	130	150	170	190	210	230	250	270	290	310	330	350	370	390	410

- SJ
- SY
- SY
- SV
- SYJ**
- SZ
- VF
- VP4
- S0700
- VQ
- VQ4
- VQ5
- VQC
- VQC4
- VQZ
- SQ
- VFS
- VFR
- VQ7

Series SYJ7000

Type 42: Side Ported/SS5YJ7-42- Stations - C6, N7 C8, N9

* []: AC

Grommet (G)

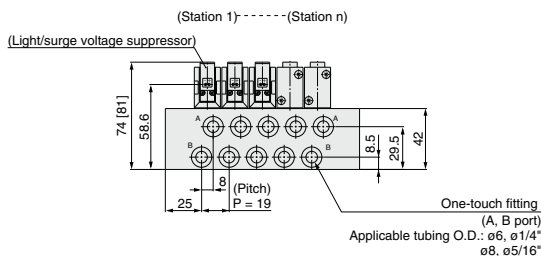
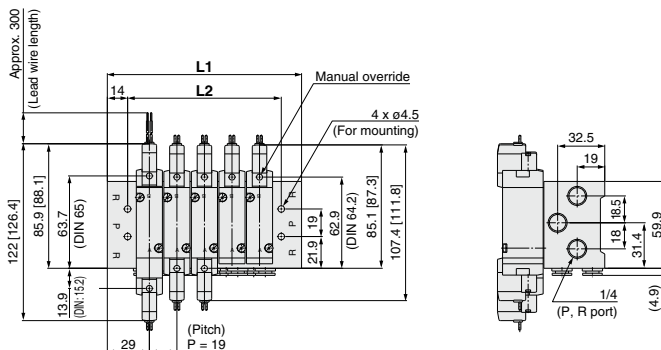

L plug connector (L)

M plug connector (M)

DIN terminal (D, Y)

M8 connector (WO)

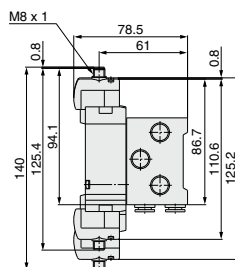
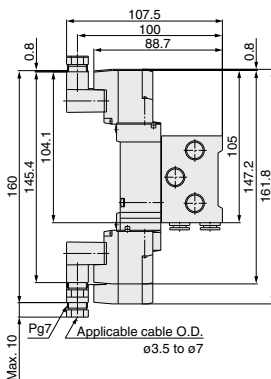
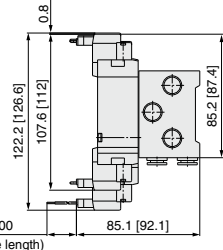
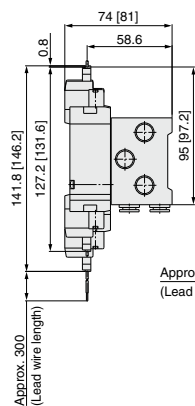

* Refer to page 755 for dimensions with connector cable.

Station n	Station 2	3	4	5	6	7	8	9	10	11	12	13	14	15	16	17	18	19	Station 20
L1	77	96	115	134	153	172	191	210	229	248	267	286	305	324	343	362	381	400	419
L2	49	68	87	106	125	144	163	182	201	220	239	258	277	296	315	334	353	372	391

Flat Ribbon Cable Manifold

* []: AC

SS5YJ7-21P-Stations(-00□)

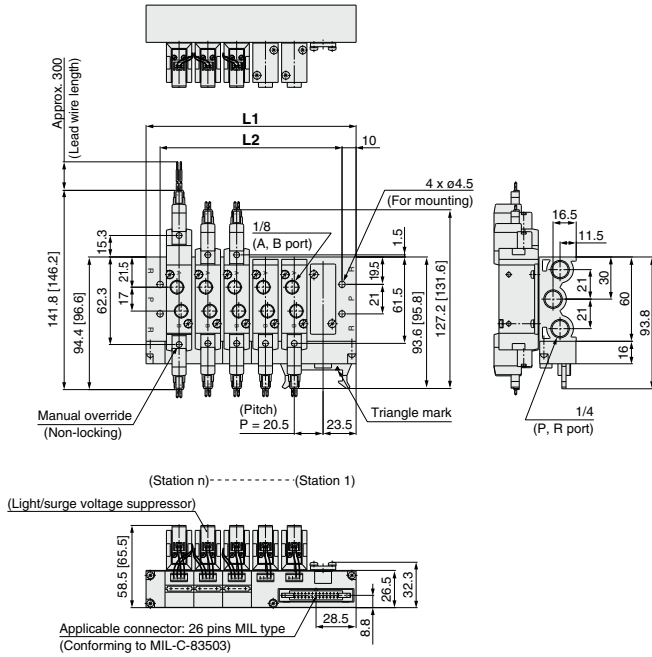

For built-in One-touch fitting

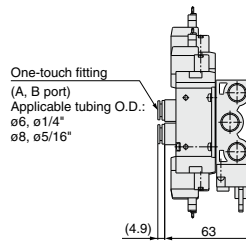

Station n	Station 3	4	5	6	7	8	9	10	11	Station 12
L1	88	108.5	129	149.5	170	190.5	211	231.5	252	272.5
L2	68	88.5	109	129.5	150	170.5	191	211.5	232	252.5

- SJ
- SY
- SY
- SV
- SYJ**
- SZ
- VF
- VP4
- S0700
- VQ
- VQ4
- VQ5
- VQC
- VQC4
- VQZ
- SQ
- VFS
- VFR
- VQ7

Series SYJ7000

EX510 Gateway-type Serial Transmission System

SS5YJ7-21SA □ - Stations - □

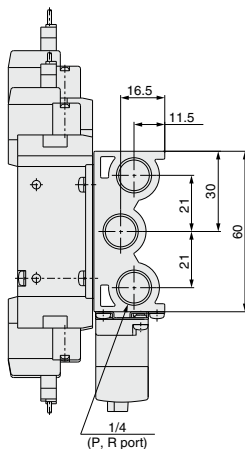
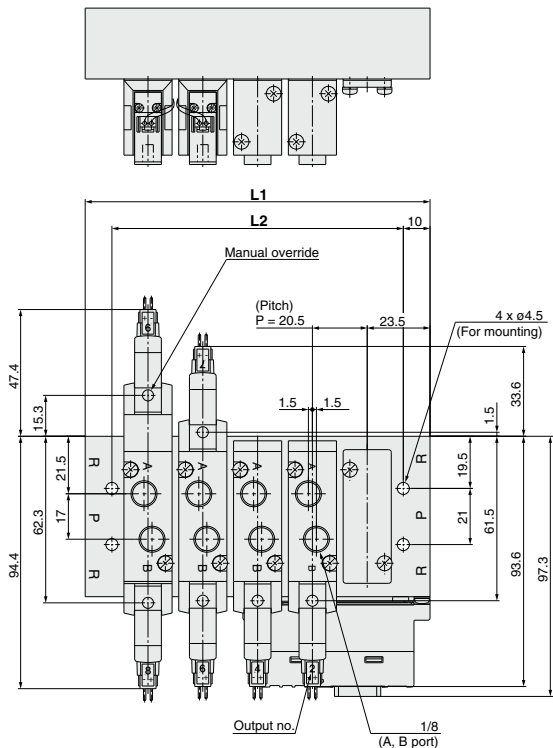

For built-in One-touch fitting

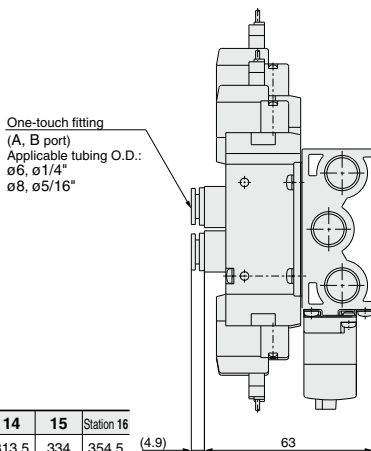
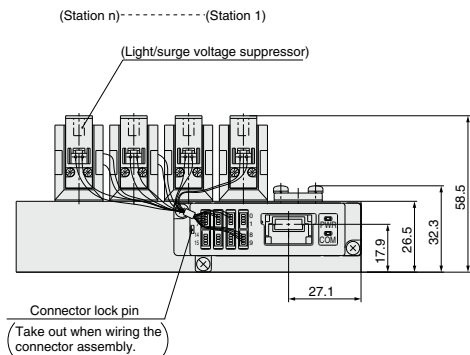

Station n	Station 3	4	5	6	7	8	9	10	11	12	13	14	15	Station 16
L1	88	108.5	129	149.5	170	190.5	211	231.5	252	272.5	293	313.5	334	354.5
L2	68	88.5	109	129.5	150	170.5	191	211.5	232	252.5	273	293.5	314	334.5

EX510 Gateway-type Serial Transmission System

SS5YJ7-41SA□ - Stations -01□

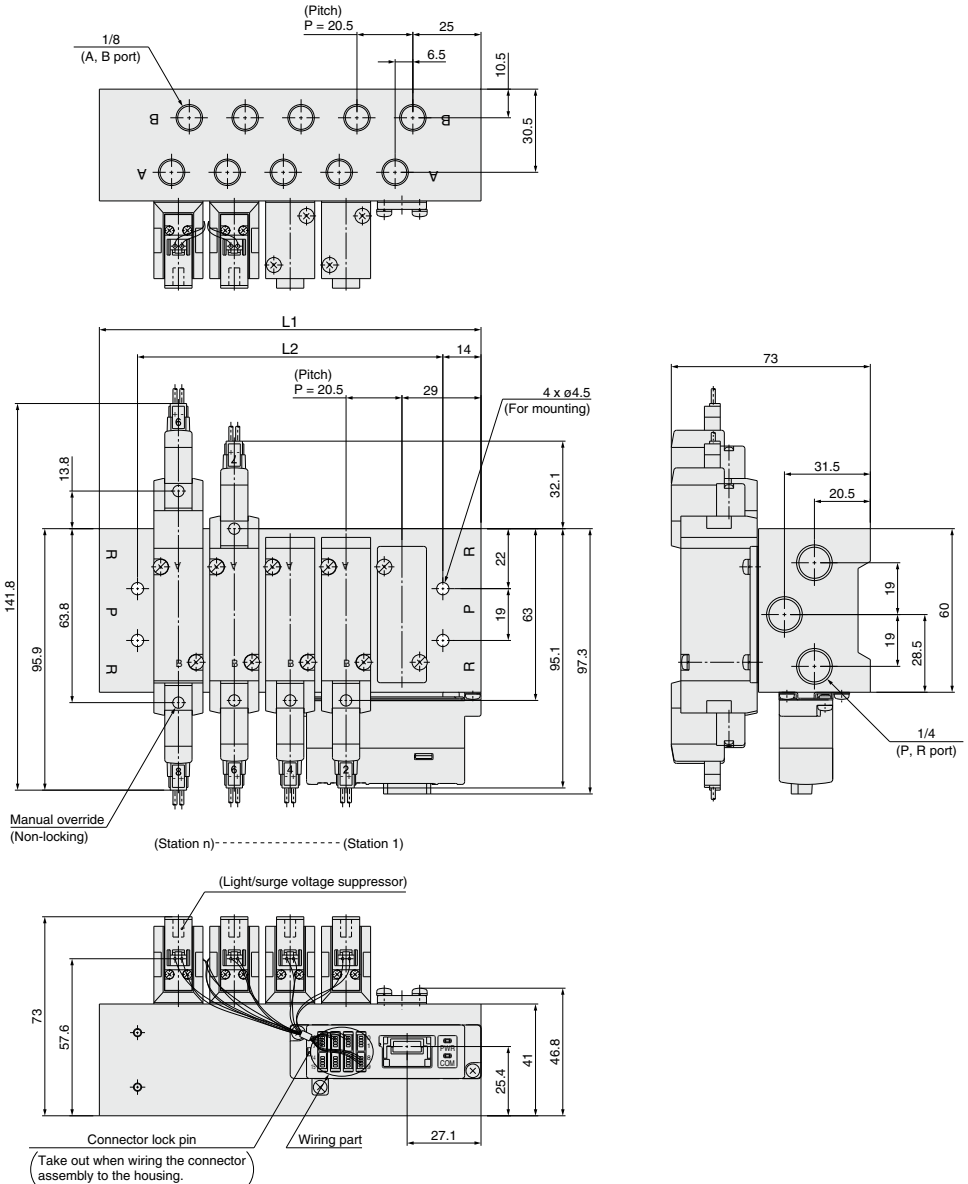

- SJ
- SY
- SY
- SV
- SYJ**
- SZ
- VF
- VP4
- S0700
- VQ
- VQ4
- VQ5
- VQC
- VQC4
- VQZ
- SQ
- VFS
- VFR
- VQ7

Station n	Station 3	4	5	6	7	8	9	10	11	12	13	14	15	Station 16
L1	99	119.5	140	160.5	181	201.5	222	242.5	263	283.5	304	324.5	345	365.5
L2	71	91.5	112	132.5	153	173.5	194	214.5	235	255.5	276	296.5	317	337.5

Series SYJ5000/7000

Made to Order

Please contact SMC for detailed dimensions, specifications, and lead times.



1 Body Ported External Pilot

Symbol
-X20

Applicable solenoid valve series SYJ5□20, SYJ7□20

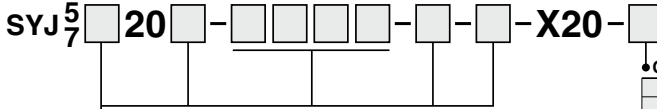

• Entry is the same as standard products.

• CE-compliant

NH	—
Q	CE-compliant

Note) AC-type models that are CE-compliant have DIN terminals only.

Operating Pressure Range MPa

Operating pressure range	-100 kPa to 0.7
Pilot pressure range	0.15 to 0.7

External Pilot Port

Series	Port size
SYJ5000, SYJ7000	M5 x 0.8

Dimensions

SYJ5000: 8 mm } longer in total length.
SYJ7000: 8 mm }

Symbol

Body ported

2 position single

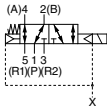

2 position double

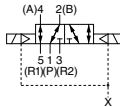

3 position closed center

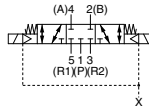

3 position exhaust center

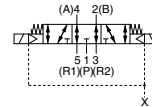

3 position pressure center

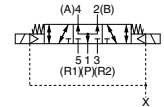



[Option]

How to Order Valve

Light/Surge voltage suppressor

Nil	Without light/surge voltage suppressor
S	With surge voltage suppressor
Z	With light/surge voltage suppressor
R	With surge voltage suppressor (Non-polar type)
U	With light/surge voltage suppressor (Non-polar type)

A, B port size

Thread piping

Symbol	Port size	Applicable series
M3	M3 x 0.5	SYJ3000
M5	M5 x 0.8	SYJ5000
01	1/8	SYJ7000

One-touch fitting piping (Metric size)

Symbol	Port size	Applicable series
C4	One-touch fitting for ø4	SYJ5000
C6	One-touch fitting for ø6	SYJ7000
C8	One-touch fitting for ø8	SYJ7000

One-touch fitting piping (Inch size)

Symbol	Port size	Applicable series
N3	One-touch fitting for ø5/32"	SYJ5000
N7	One-touch fitting for ø1/4"	SYJ7000
N9	One-touch fitting for ø5/16"	SYJ7000

Bracket

Nil	Without bracket
F	With bracket

Note) Do not remove the factory installed bracket from Series SYJ7000 with the bracket option. Removal of the bracket will cause the valve to leak.

Type of actuation

1	2 position single solenoid
2	2 position double solenoid
3	3 position closed center
4	3 position exhaust center
5	3 position pressure center

Rated voltage

5	24 VDC
6	12 VDC
V	6 VDC
S	5 VDC
R	3 VDC

Body option

0: Pilot valve individual exhaust for the pilot valve

3: Common exhaust type for main and pilot valve

Electrical entry

WAO: Without connector Cable

WA□: With connector Cable Note)

CE-compliant

Nil	—
Q	CE-compliant

Port size

Nil	Without sub-plate	
M5	M5 x 0.8	SYJ3000
01	1/8	SYJ5000
02	1/4	SYJ7000

Manual override

Nil	Non-locking push type
D	Push-turn locking slotted type
E	Push-turn locking lever type

Note) Enter the cable length symbol in □.
Please be sure to fill in the blank referring to page 754.

Body ported SYJ 3 1 2 0 - 5 WAO □ □ - M3 - □ - □ - □

Base mounted (4 port) SYJ3 2 3 0 - 5 WAO □ □ - □ (For manifold use only)

Base mounted (5 port) SYJ 3 2 4 0 - 5 WAO □ □ - □ - □ - □

Series

3	SYJ3000
5	SYJ5000
7	SYJ7000

How to Order Pilot Valve Assembly

V111- 5 WAO □

Rated voltage

DC

5	24 VDC
6	12 VDC
V	6 VDC
S	5 VDC
R	3 VDC

Light/Surge voltage suppressor

Nil	Without light/surge voltage suppressor
S	With surge voltage suppressor
Z	With light/surge voltage suppressor
R	With surge voltage suppressor (Non-polar type)
U	With light/surge voltage suppressor (Non-polar type)

Electrical entry

WAO	Without connector Cable
WA□	M8 connector With connector Cable <small>Note)</small>

Note) Enter the cable length symbol in □.
Please be sure to fill in the blank referring to page 754.

Note) Since V111 is CE-compliant as standard, the suffix "-Q" is not necessary.

SYJ
SY
SV
SYJ
SZ
VF
VP4
S0700
VQ
VQ4
VQ5
VQC
VQC4
VQZ
SQ
VFS
VFR
VQ7



Series SYJ3000/5000/7000 Specific Product Precautions 1

Be sure to read before handling.

Refer to front matter 53 for Safety Instructions and pages 3 to 8 for 3/4/5 Port Solenoid Valve Precautions.

Manual Override Operation

Warning

When the manual override is operated, connected equipment will be actuated. Confirm safety before operating.

■ Non-locking push type [Standard]

Press in the direction of the arrow



■ Push-turn locking slotted type [Type D]

While pressing, turn in the direction of the arrow.

If it is not turned, it can be operated the same way as the non-locking type.



Locked position



Caution

When operating the locking type D with a screw driver, turn it gently using a watchmakers screw driver.
[Torque: Less than 0.1 N·m]

■ Push-turn locking lever type [Type E]

While pressing, turn in the direction of the arrow.

If it is not turned, it can be operated the same way as the non-locking type.



Locked position



Caution

When locking the manual override on the push-turn locking types (D, E), be sure to push it down before turning. Turning without first pushing it down can cause damage to the manual override and trouble such as air leakage, etc.

Solenoid Valve for 200, 220 VAC Specifications

Warning

Solenoid valves with grommet and L/M type plug connector AC specifications have a built-in rectifier circuit in the pilot section to operate the DC coil.

With 200, 220 VAC specification pilot valves, this built-in rectifier generates heat when energized. The surface may become hot depending on the energized condition; therefore, do not touch the solenoid valves.

Common Exhaust Type for Main and Pilot Valve

Caution

Pilot air is exhausted through the main valve body rather than directly to atmosphere.

- Suitable for applications where exhausting the pilot valve to atmosphere would be detrimental to the surrounding working environment.
- For use in extremely dirty environments where there is the possibility that dust could enter the pilot exhaust and damage the valve.

Ensure that the piping of exhaust air is not too restrictive.

Series SYJ3000/5000/7000 Mixed Installation of 3 Port and 5 Port Valves on Same Manifold.

Caution

Series SYJ3000/5000/7000 and Series SYJ300/500/700 can be mounted on the same manifold. How to mount on the same manifold is shown on the following pages.

SYJ3000, SYJ300	P. 678
SYJ5000, SYJ500	P. 707
SYJ7000, SYJ700	P. 739

If 4 or 5 port valve is used as a 3 port valve
Series SYJ3000, 5000, 7000 may be used as a N.C. or N.O. 3 port valve by plugging one of the A,B ports. Be sure not to plug the exhaust ports (R). Can be used when a double solenoid, 3 port valve is required.

Plug position		B port	A port
Type of actuation		N.C.	N.O.
Number of solenoids	Single		
	Double		

(JIS symbols above: Series SYJ5000)



Series SYJ3000/5000/7000 Specific Product Precautions 2

Be sure to read before handling.

Refer to front matter 53 for Safety Instructions and pages 3 to 8 for 3/4/5 Port Solenoid Valve Precautions.

How to Use Plug Connector

⚠ Caution

1. Attaching and detaching connectors

- To attach a connector, hold the lever and connector unit between your fingers and insert straight onto the pins of the solenoid valve so that the lever's pawl is pushed into the groove and locks.
- To detach a connector, remove the pawl from the groove by pushing the lever downward with your thumb, and pull the connector straight out.

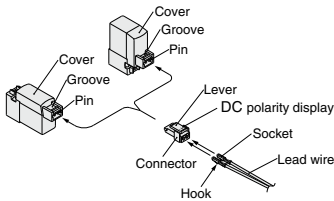

2. Crimping of lead wires and sockets

Strip 3.2 to 3.7 mm at the end of the lead wires, insert the ends of the core wires evenly into the sockets, and then crimp with a crimping tool. When this is done, take care that the coverings of the lead wires do not enter the core wire crimping area.

Use an exclusive crimping tool for crimping.
(Contact SMC for special crimping tools.)

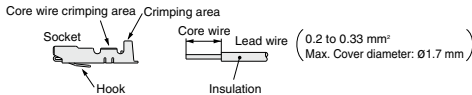

3. Attaching and detaching sockets with lead wires

• Attaching

Insert the sockets into the square holes of the connector (+, - indication), and continue to push the sockets all the way in until they lock by hooking into the seats in the connector. (When they are pushed in, their hooks open and they are locked automatically.) Then confirm that they are locked by pulling lightly on the lead wires.

• Detaching

To detach a socket from a connector, pull out the lead wire while pressing the socket's hook with a stick having a thin tip (approx. 1 mm). If the socket will be used again, first spread the hook outward.

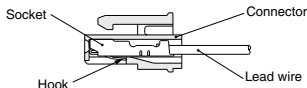

Plug Connector Lead Wire Length

⚠ Caution

Standard length is 300 mm, but the following lengths are also available.

How to Order Connector Assembly

For DC: **SY100-30-4A**

For 100 VAC: **SY100-30-1A**

For 200 VAC: **SY100-30-2A**

For other voltages of AC: **SY100-30-3A**

Without lead wire: **SY100-30-A**
(with connector and 2 of sockets only)

• Lead wire length

Nil	300 mm
6	600 mm
10	1000 mm
15	1500 mm
20	2000 mm
25	2500 mm
30	3000 mm
50	5000 mm

How to Order

Include the connector assembly part number together with the part number for the plug connector's solenoid valve without connector.

Ex.) In case of 2000 mm of lead wire

For DC

SYJ3120-5LO-M3

SY100-30-4A-20

For AC

SYJ3120-1LO-M3

SY100-30-1A-20

SJ

SY

SY

SV

SYJ

SZ

VF

VP4

VP4

S0700

VQ

VQ4

VQ5

VQC

VQC4

VQZ

SQ

VFS

VFR

VQ7



Series SYJ3000/5000/7000

Specific Product Precautions 3

Be sure to read before handling.

Refer to front matter 53 for Safety Instructions and pages 3 to 8 for 3/4/5 Port Solenoid Valve Precautions.

Surge Voltage Suppressor

Caution

<For DC>

Grommet, L/M Plug Connector



■ Standard type (with polarity) Surge voltage suppressor (□S)

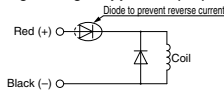

With light/surge voltage suppressor (□Z)

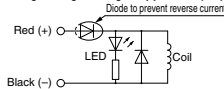

■ Non-polar type

With surge voltage suppressor (□R)

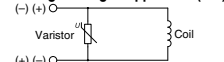

With light/surge voltage suppressor (□U)

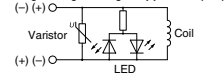

- Connect the standard type in accordance with the +, - polarity indication. (The non-polar type can be used with the connections made either way.)
- Since voltage specifications other than standard 24 and 12 VDC do not have diodes for polarity protection, be careful not to make errors in the polarity.
- When wiring is done at the factory, positive (+) is red and negative (-) is black.

■ With power saving circuit

Power consumption is decreased by 1/4 by reducing the wattage required to hold the valve in an energized state. (Effective energizing time is over 62 ms at 24 VDC.)

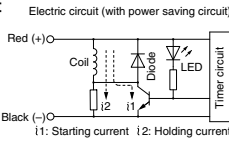

Operating Principle

With the above circuit, the current consumption when holding is reduced to save energy. Please refer to the electric wave data to the right.

- Please be careful not to reverse the polarity, since a diode to prevent the reversed current is not provided for the power saving circuit.

(In the case of SYJ3000T, the electric wave form of energy saving type)

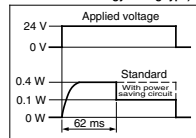

DIN Terminal

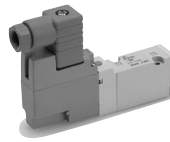

With surge voltage suppressor (DS)

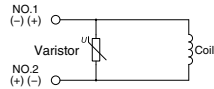

With light/surge voltage suppressor (DZ)

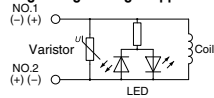

DIN terminal has no polarity.

M8 Connector

■ Standard type (with polarity)

With light/surge voltage suppressor (□S)

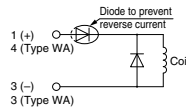

With light/surge voltage suppressor (□Z)

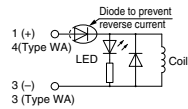

■ Non-polar type

With surge voltage suppressor (□R)

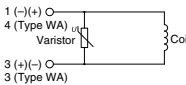

With light/surge voltage suppressor (□U)

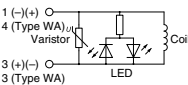

Solenoid valve side pin wiring diagram

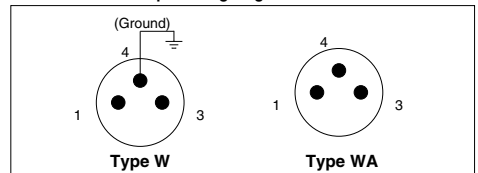

- For the standard type, connect + to 1 and - to 3 for Type W according to polarity, while + to 4 and - to 3 for Type WA.
- Please be careful not to reverse the polarity, since a diode to prevent the reversed current is not provided for DC voltages other than 24 and 12 VDC.
- The WA-type valve cannot be grounded.



Series SYJ3000/5000/7000

Specific Product Precautions 4

Be sure to read before handling.

Refer to front matter 53 for Safety Instructions and pages 3 to 8 for 3/4/5 Port Solenoid Valve Precautions.

Surge Voltage Suppressor

<For AC>

(There is no "S" type because the generation of surge voltage is prevented by a rectifier.)

Grommet, L/M Plug Connector

With light (□Z)

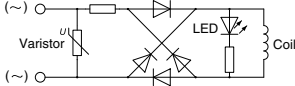

DIN Terminal

With light (DZ)

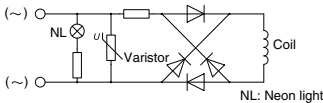

Note) Surge voltage suppressor of varistor has residual voltage corresponding to the protective element and rated voltage; therefore, protect the controller side from the surge. The residual voltage of the diode is approximately 1 V.

DIN Terminal Type Y

- A Y-type DIN connector is a DIN connector conforming to the 8-mm standard pitch between DIN terminals.
- D-type DIN connector with 9.4 mm pitch between terminals if not interchangeable.
- DIN connector except D-type has the "N" indication at the end of voltage symbol. (In case of DIN connector without light, "N" is not indicated. Please refer to the name plate to distinguish.)
- Dimensions are the same as D-type DIN connector.
- When exchanging the pilot valve assembly only, V115-□D is interchangeable with V115-□Y. Do not replace V114 (G, H, L, M, W) to V115-□D/□Y (DIN terminal), or vice versa.

How to Use DIN Terminal

Caution

Connection

1. Loosen the holding screw and pull the connector out of the solenoid valve terminal block.
2. After removing the holding screw, insert a flat head screwdriver, etc. into the notch on the bottom of the terminal block and pry it open, separating the terminal block and the housing.
3. Loosen the terminal screws (slotted screws) on the terminal block, insert the cores of the lead wires into the terminals according to the connection method, and fasten them securely with the terminal screws.
4. Secure the cord by fastening the ground nut.

Caution

When making connections, take note that using other than the supported size (ø3.5 to ø7) heavy duty cord will not satisfy IP65 (enclosure) standards. Also, be sure to tighten the ground nut and holding screw within their specified torque ranges.

Caution

Changing the entry direction

After separating the terminal block and housing, the cord entry can be changed by attaching the housing in the desired direction

How to Use DIN Terminal

(4 directions at 90° intervals).

* When equipped with a light, be careful not to damage the light with the cord's lead wires.

Precautions

Plug in and pull out the connector vertically without tilting to one side.

Compatible cable

Cord O.D.: ø3.5 to ø7

(Reference) 0.5 mm², 2-core or 3-core, equivalent to JIS C 3306

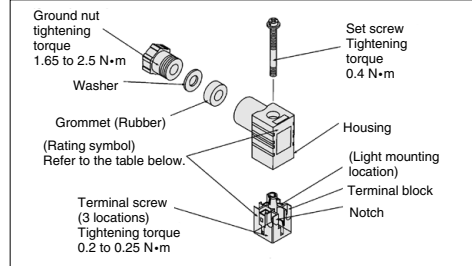

DIN Connector Part No.

Caution

<Type D>

Without light			SY100-61-1
With light			
Rated voltage	Voltage symbol	Part no.	
24 VDC	24V	SY100-61-3-05	
12 VDC	12V	SY100-61-3-06	
100 VAC	100V	SY100-61-2-01	
200 VAC	200V	SY100-61-2-02	
110 VAC	110V	SY100-61-2-03	
220 VAC	220V	SY100-61-2-04	

< Type Y >

Without light			SY100-82-1
With light			
Rated voltage	Voltage symbol	Part no.	
24 VDC	24VN	SY100-82-3-05	
12 VDC	12VN	SY100-82-3-06	
100 VAC	100VN	SY100-82-2-01	
200 VAC	200VN	SY100-82-2-02	
110 VAC(115 VAC)	110VN	SY100-82-2-03	
220 VAC(230 VAC)	220VN	SY100-82-2-04	

Circuit Diagram with Light

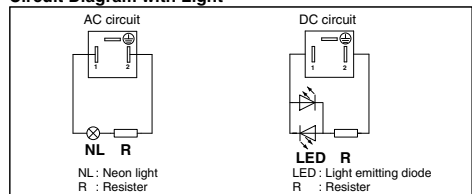

SJ
SY
SY
SV
SYJ
SZ
VF
VP4
S0700
VQ
VQ4
VQ5
VQC
VQC4
VQZ
SQ
VFS
VFR
VQ7



Series SYJ3000/5000/7000 Specific Product Precautions 5

Be sure to read before handling.
Refer to front matter 53 for Safety Instructions and pages 3 to 8 for 3/4/5 Port Solenoid Valve Precautions.

Connector Assembly with Cover

⚠ Caution

- Connector assembly with dust proof protective cover.**
- Effective to prevention of short circuit failure due to the entry of foreign matter into the connector.
 - Chloroprene rubber for electrical use, which provides outstanding weather resistance and electrical insulation, is used for the cover material. However, do not allow contact with cutting oil, etc.
 - Simple and unencumbered appearance by adopting round-shaped cord.

How to Order

SY100-68-A-

• Lead wire length

Nil	300 mm
6	600 mm
10	1000 mm
15	1500 mm
20	2000 mm
25	2500 mm
30	3000 mm
50	5000 mm

Connector Assembly with Cover: Dimensions

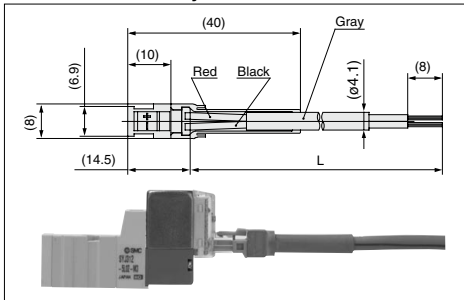

How to Order

Enter the part number for a plug connector solenoid valve without connector together with the part number for a connector assembly with cover.

- Ex. 1) Lead wire length of 2000 mm
SYJ3120-5LOZ-M3
SY100-68-A-20
- Ex. 2) Lead wire length of 300 mm (standard)
SYJ3120-5LPZ-M3

Symbol for connector assembly with cover

* In this case, the part number for the connector assembly with cover is not required.

M8 Connector

⚠ Caution

1. M8 connector types have an IP65 (enclosure) rating, offering protection from dust and water. However please note: these products are not intended for use in water. Select a SMC connector cable (V100-49-1-□) or a FA sensor type connector, with M8 threaded 3 pin specifications conforming to Nippon Electric Control Equipment Association Standard, NECA4202 (IEC60947-5-2). Make sure the connector O.D. is 10.5 mm or less when used with the Series SYJ3000 manifold. If more than 10.5 mm, it cannot be mounted due to the size.
2. Do not use a tool to mount the connector, as this may cause damage. Only tighten by hand. (0.4 to 0.6 N·m)
3. The excessive stress on the cable connector will not be able to satisfy the IP65 rating. Please use caution and do not apply a stress of 30 N or greater.

⚠ Caution

Failure to meet IP65 performance may result if using alternative connectors than those shown above, or when insufficiently tightened.

- Connector cable mounting

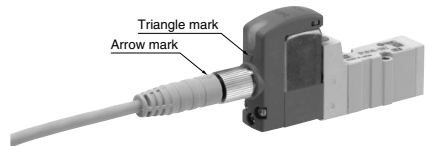

Note) Connector cable should be mounted in the correct direction. Make sure that the arrow symbol on the connector is facing the triangle symbol on the valve when using SMC connector cable (V100-49-1-□). Be careful not to squeeze it in the wrong direction, as problems such as pin damage may occur.

■ Connector cable

- M8 connector cable for M8 can be ordered as follows:

How to Order

1. To order solenoid valve and connector cable at the same time
(Connector cable will be included in the shipment of the solenoid valve.)

SYJ³/₅ □ □ □ - □ □ □ □ - □ □

↓ Electrical entry

- W1,WA1:** Cable length 300 mm
- W2,WA2:** Cable length 500 mm
- W3,WA3:** Cable length 1000 mm
- W4,WA4:** Cable length 2000 mm
- W7,WA7:** Cable length 5000 mm

- Ex. 1) Cable length: 300 mm
SYJ3120-5W1ZE-M3

Symbol for electrical entry



Series SYJ3000/5000/7000 Specific Product Precautions 6

Be sure to read before handling.
Refer to front matters 53 for Safety Instructions and pages 3 to 8 for 3/4/5 Port Solenoid Valve Precautions.

M8 Connector

2. To order connector cable only

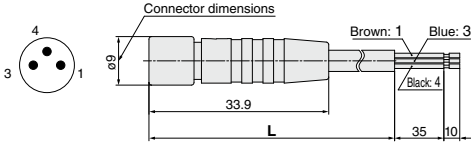

Cable length (L)	No.
300 mm	V100-49-1-1
500 mm	V100-49-1-2
1000 mm	V100-49-1-3
2000 mm	V100-49-1-4
5000 mm	V100-49-1-7

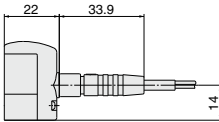

Flat Ribbon Cable Manifold

Caution

Type 21P

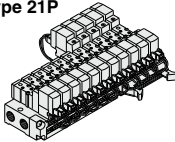

Type 32P

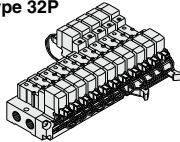

- In the manifold valves, the wiring to the individual valves is provided on a printed circuit board, and the connection to the external wires is consolidated through the use of a flat ribbon cable.
- A single MIL flat ribbon cable connects the entire manifold to your power source. This greatly reduces installation time.

Flat Ribbon Cable Manifold

Manifold Internal Wiring

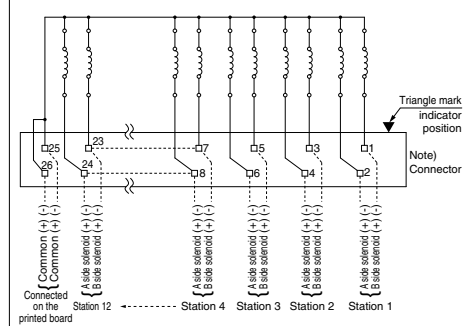

(Max. 12 stations)

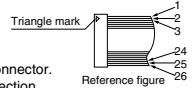

Note)

Terminal no. is not indicated on the connector. The terminal no. indicated in the connection schematic of connector, as shown in the reference, means a correlation of 1, 2, 3...26 from the triangle mark side on the flat ribbon cable of connector.

- For more than 10 stations, both poles of the common should be wired.
- For single solenoid, connect to the B side solenoid.
- The maximum number of stations that can be accommodated is 12. For more stations, contact SMC.
- Only non-polar valves are available for the DC flat cable manifold, therefore negative COM or positive COM wiring of the manifold is possible. The valve does not switch with negative COM if a Z type is used. Be sure to use a positive COM.

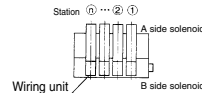

- SJ
- SY
- SY
- SV
- SYJ
- SZ
- VF
- VP4
- S0700
- VQ
- VQ4
- VQ5
- VQC
- VQC4
- VQZ
- SQ
- VFS
- VFR
- VQ7



Series SYJ3000/5000/7000 Specific Product Precautions 7

Be sure to read before handling.

Refer to front matter 53 for Safety Instructions and pages 3 to 8 for 3/4/5 Port Solenoid Valve Precautions.

EX510 Gateway-type Serial Transmission System

When ordering the connector assembly only

For single solenoids (SY3000-37-81A-□-N)

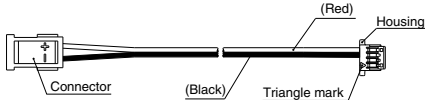

For double solenoids (SY3000-37-81A-□-□)

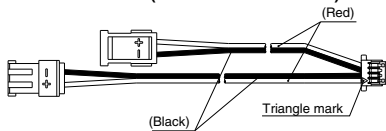

Connector Assembly Order No.

(Can be used for the manifold without a specified layout (8 stations or less))

Model	Part no.	Connector mounting position
SS5YJ3- ²¹ / ₃₂ SA	SY3000-37-81A-2-N	Single : 1 to 4 stations
	SY3000-37-81A-2-5	Double/3 position : 1 to 4 stations
	SY3000-37-81A-1-N	Single : 5 to 8 stations
SS5YJ5- ²⁰ / ₄₁ / ₄₂ / ₄₃ SA	SY3000-37-81A-1-4	Double/3 position : 5 to 8 stations
	SY3000-37-81A-2-N	Single : 1 to 8 stations
	SY3000-37-81A-2-5	Double/3 position : 1 to 8 stations
SS5YJ7- ²¹ / ₄₁ SA	SY3000-37-81A-3-N	Single : 1 to 8 stations
	SY3000-37-81A-3-6	Double/3 position : 1 to 4 stations
	SY3000-37-81A-3-7	Double/3 position : 5 to 8 stations

Note) The above is for the station addition or maintenance. When ordering a connector assembly separately, a number would not be printed on the connector.

When ordering connector assembly (except housing)

SY3000-37-80A-□

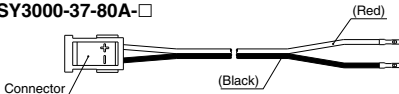

Connector Assembly Order No.

(Can be used for the manifold with a specified layout)

Model	Part no.	Connector mounting position
SS5YJ3- ²¹ / ₃₂ SA	SY3000-37-80A-5	On A side : 1 to 8 stations
	SY3000-37-80A-2	On B side : 1 to 8 stations
	SY3000-37-80A-7	On A side : 9 to 16 stations
	SY3000-37-80A-4	On B side : 9 to 16 stations
SS5YJ5- ²⁰ / ₄₁ / ₄₂ / ₄₃ SA	SY3000-37-80A-5	On A side : 1 to 8 stations
	SY3000-37-80A-2	On B side : 1 to 8 stations
	SY3000-37-80A-7	On A side : 9 to 12 stations
	SY3000-37-80A-4	On B side : 9 to 12 stations
	SY3000-37-80A-9	On A side : 13 to 16 stations
	SY3000-37-80A-7	On B side : 13 to 16 stations
SS5YJ7- ²¹ / ₄₁ SA	SY3000-37-80A-7	On A side : 1 to 8 stations
	SY3000-37-80A-3	On B side : 1 to 8 stations
	SY3000-37-80A-10	On A side : 9 to 12 stations
	SY3000-37-80A-6	On B side : 9 to 12 stations
	SY3000-37-80A-12	On A side : 13 to 16 stations
	SY3000-37-80A-9	On B side : 13 to 16 stations

Note 1) The above is for station addition or maintenance. When ordering a connector assembly separately, a number will not be printed on the connector.

Note 2) After inserting the connector assembly into the housing, be sure to confirm that the lead wire will not come off by lightly pulling the wire. Furthermore, do not reuse the lead wire after it has been inserted and removed.

Note 3) Wiring is set longer than the actual wiring distance.

When ordering the housing only

SY3000-44-3A (8 pcs./set)

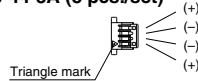

Bracket

Caution

For bracket attached styles of SYJ3000 (Single) and SYJ7000, do not use it without bracket.

Replacement of Pilot Valve

Caution

Mount it so that there is no slippage or deformation in gaskets, and tighten with the tightening torque as shown below.

Series	Thread size	Tightening torque
SYJ3000	M1.7	0.12 N·m
SYJ5000	M2.5	0.45 N·m
SYJ7000	M3	0.8 N·m



Series SYJ3000/5000/7000 Specific Product Precautions 8

Be sure to read before handling.

Refer to front matter 53 for Safety Instructions and pages 3 to 8 for 3/4/5 Port Solenoid Valve Precautions.

Replacement of Pilot Valve

⚠ Caution

Pilot valves in this series are improved to provide excellent energy saving results. However following this improvement, these new valves are no longer compatible with the conventional pilot valve used at the interface. Consult with SMC when you need to exchange these pilot valves, in the case of manual override (marked in orange) of the adapter plate.

New type

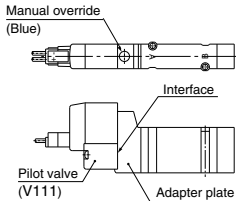

Conventional type

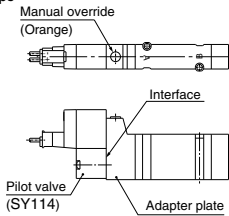

Interface Regulator

⚠ Caution

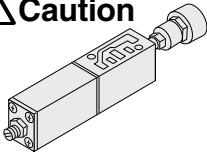

Spacer type regulating valve on manifold block can regulate the pressure to the valve individually.

Specifications

Interface regulator	ARBYJ5000	ARBYJ7000	
Applicable solenoid valve model	SYJ5000	SYJ7000	
Regulating port	P	P	
Proof pressure	1.5 MPa		
Maximum operating pressure	1.0 MPa		
Set pressure range	0.05 to 0.7 MPa ^{Note 1)}		
Ambient and fluid temperature	-5 to 60°C (No freezing) ^{Note 2)}		
Thread size for connection of pressure gauge	M5 x 0.8		
Weight (kg)	0.06	0.09	
Effective area at exhaust side (mm ²) S at P ₁ = 0.7 MPa, P ₂ = 0.5 MPa	P→A	1.9	5.1
	P→B	2.1	5.8
Effective area at supply side (mm ²) S at P ₂ = 0.5 MPa	A→EA	4.5	12.6
	B→EB	4.5	12.6

Interface Regulator

- Note 1) Set the pressure within the operating pressure range of the solenoid valve.
- Note 2) The maximum operating temperature for the solenoid valve is 50°C.
- Note 3) The effective area listed is for a single solenoid 2 position valve mounted on a sub-plate.
- Note 4) Apply pressure from P port in the base for interface regulator.

Flow Characteristics

(P → A) Condition: Inlet pressure 0.7 MPa

● ARBYJ5000-00-P

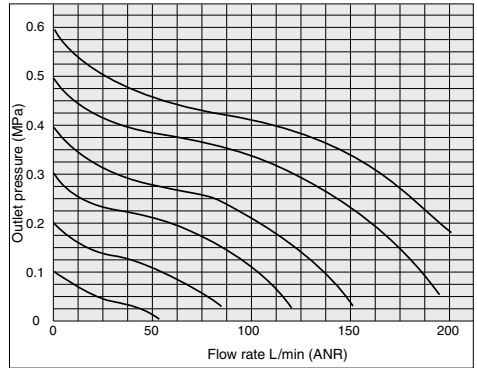

▼ ARBYJ7000-00-P

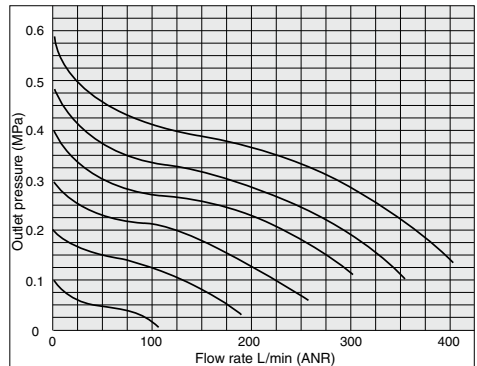

SJ
SY
SY
SV
SYJ
SZ
VF
VP4
S0700
VQ
VQ4
VQ5
VQC
VQC4
VQZ
SQ
VFS
VFR
VQ7