

Miniature Fittings Stainless Steel 316

Series MS

RoHS

Applicable Tubes: $\phi 3.2$, $\phi 4$, $\phi 6$ Connection Thread: M5, R 1/8

For use in corrosive environments Stainless steel 316

Compact piping space

Tube has a large retaining force. Hose nipple assures easy installation and removal.

Line up various types

Possible for special tubing in the same direction. Accepts many styles of plastic tubing

Hose nipple and hose elbow

Accepts nylon, soft nylon, and polyurethane tubing.

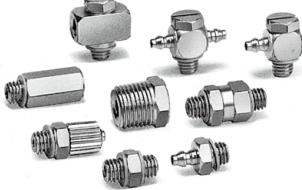

Made to Order
Made to Order
(Refer to page 290 for details.)

Hose nipple

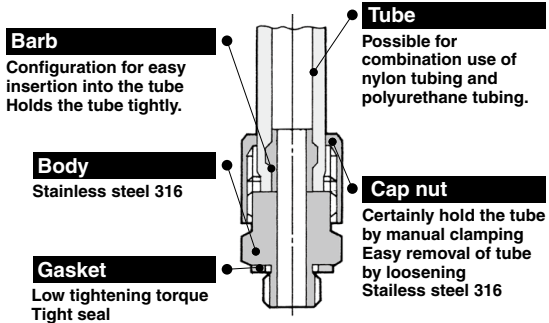

Barb fitting

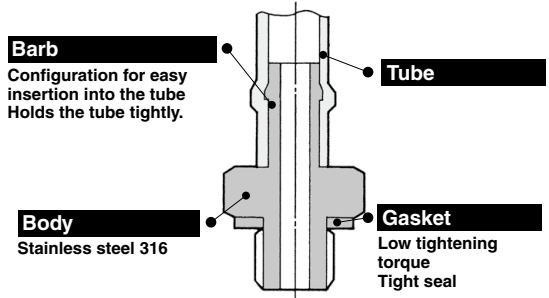

Specifications

Applicable tubing material	Nylon	Soft nylon ⁽¹⁾	Polyurethane	Super PFA ⁽²⁾	FEP ⁽³⁾	Modified PTFE ⁽⁴⁾
Applicable tubing O.D./I.D.	$\phi 4/\phi 2.5$ $\phi 6/\phi 4$	$\phi 3.18/\phi 2.18$	$\phi 4/\phi 2.5$ $\phi 6/\phi 4$	$\phi 3.18/\phi 2$ $\phi 4/\phi 2.5$ $\phi 6/\phi 4$	$\phi 6/\phi 4$	$\phi 4/\phi 2.5$ $\phi 6/\phi 4$
Fluid	Air/Water ⁽⁵⁾					
Maximum operating pressure (at 20°C)	1.5 MPa	1 MPa	0.8 MPa	1 MPa	1.5 MPa	1.4 MPa
Ambient and fluid temperature	-5 to 60°C, Water: 0 to 40°C (No freezing)					
Connection size	M5, R 1/8					M5
Thread	JIS B0205 (Metric fine thread) JIS B0203 (Taper thread for piping)			JIS B0205, Class 2 (Metric fine thread)		

Note 1) Soft nylon tubing is not compatible with water.











Note 2) , Note 3) , Note 4) Applicable only for hose nipple type.









Note 5) Barb fitting, barb elbow and barb tee are not compatible with water.

Principal Parts Material

Material	Body	Gasket
	Stainless steel 316	PVC, Nylon 66, GF30%

Model

Model	Description	Application	Note
MS-5AU-3		For soft nylon tube	ø3.18/ø2.18 x M5
		For polyurethane tube	ø3.18/ø2 x M5
MS-5AU-4		For soft nylon and polyurethane tube	ø4/ø2.5 x M5
MS-5AU-6			ø6/ø4 x M5
P.288			
MS-5ALHU-3		For soft nylon tube	ø3.18/ø2.18 x M5
		For polyurethane tube	ø3.18/ø2 x M5
MS-5ALHU-4		For soft nylon and polyurethane tube	ø4/ø2.5 x M5
MS-5ALHU-6			ø6/ø4 x M5
P.288			
MS-5H-4		For nylon, soft nylon, and polyurethane tube	ø4/ø2.5 x M5
MS-5H-6			ø6/ø4 x M5
P.288			
MS-5HLH-4		<ul style="list-style-type: none"> For nylon, soft nylon, and polyurethane tube Body rotates at 360° around the stud axis 	ø4/ø2.5 x M5
MS-5HLH-6			ø6/ø4 x M5
P.288			

Model	Description	Application	Note
MS-5UL	 P.288	Body rotates at 360° around the stud axis	M5 female x M5 male
MS-5UT	 P.288	Body rotates at 360° around the stud axis	M5 female x M5 female x M5 male
MS-5B	 P.289	For reducing Rc 1/8 female to M5 female	R 1/8 x M5 female
MS-5P	 P.289	Use to plug unused M5 port.	
MS-5J	 P.289	Solid piece moves fitting up from work piece	M5 male x M5 female
MS-5N	 P.289	Fitting to workpiece and fitting to fitting connection	M5 male x M5 male
MS-5UN	 P.289	Body rotates at 360° around the stud axis	M5 male x M5 male
MS-5ATHU-3		For soft nylon tube	ø3.18/ø2.18 x M5
		polyurethane tube	
MS-5ATHU-4		For soft nylon and polyurethane tube	ø4/ø2.5 x M5
			MS-5ATHU-6
P.289			

KQ2

KQB2

KS
KX

KM

KF

M

H/DL
L/LL

KC

KK

KK130

DM

KDM

KB

KR

KA

KQG2

KG

KFG2

MS

KKA

KP

LQ

MQR

T

Series MS

Barb Fitting for Soft Tube: MS-5AU-3/4/6



Model	C	øD	L	Effective area (mm ²)	Weight (g)
MS-5AU-3	4.5	1.6	11.5	1.7	1.4
MS-5AU-4	5	1.8	12	2.1	1.5
MS-5AU-6	7	2.5	14	4.0	1.7

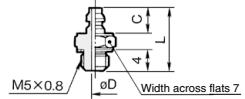

Barb Elbow for Soft Nylon: MS-5ALHU-3/4/6



Model	A	C	øD	L	Effective area (mm ²)	Weight (g)
MS-5ALHU-3	8	4.5	1.6	11.8	1.1	3
MS-5ALHU-4	8.8	5	1.8	12.6	1.4	3.1
MS-5ALHU-6	10.8	7	2.5	14.6	2.4	3.7

MS-5ALHU-3, -4

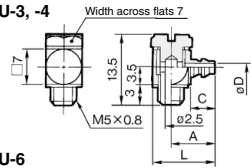

MS-5ALHU-6

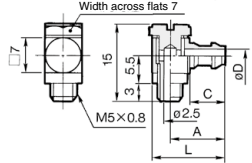

Hose Nipple: MS-5H-4/6



Model	B	øD	L	E	øF	Effective area (mm ²)	Weight (g)
MS-5H-4	7	1.8	15.5	7	6.5	2.1	2.5
MS-5H-6	8	2.5	16.5	8	8.5	4.0	3.7

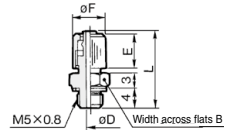

Hose Elbow: MS-5HLH-4/6



Model	A	B	C	øD	E	øF	L	M	N	Effective area (mm ²)	Weight (g)
MS-5HLH-4	12	7	8.5	1.8	7	6.5	15.8	15	5.5	1.4	4.2
MS-5HLH-6	13.5	8	9.5	2.5	8	8.5	17.8	16	6	2.5	6.2

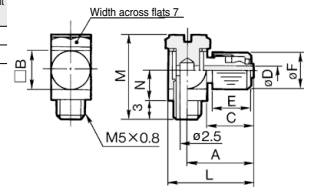

Universal Elbow: MS-5UL

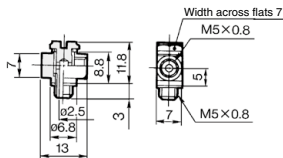

Effective area: 2.4 mm²
Weight: 4.5 g

Universal Tee: MS-5UT



Effective area: 2.4 mm²
Weight: 4.5 g

Bushing: MS-5B

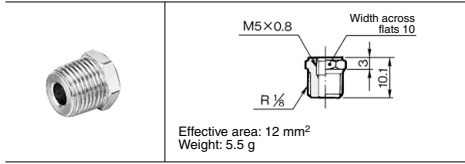

Plug: MS-5P

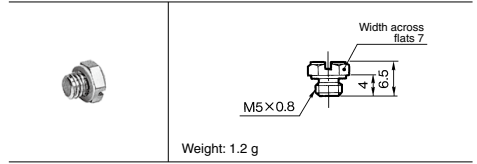

Extension Fitting: MS-5J

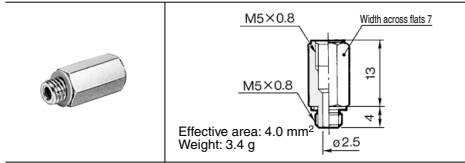

Nipple: MS-5N

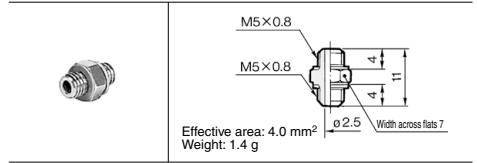

Barb Tee for Soft Tube: MS-5ATHU-3/4/6

Model	A1	A2	C	øD	Effective area (mm ²)	Weight (g)
MS-5ATHU-3	8	8.3	4.5	1.6	1.1	3.4
MS-5ATHU-4	8.8	8.8	5	1.8	1.4	3.6
MS-5ATHU-6	10.8	10.8	7	2.5	2.4	4.2

MS-5ATHU-3, -4

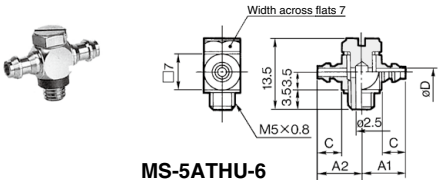

MS-5ATHU-6

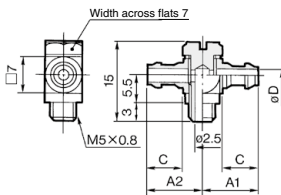

Universal Nipple: MS-5UN

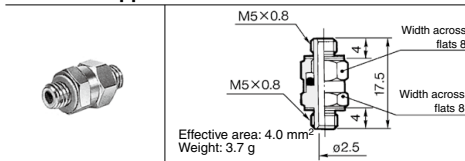

KQ2

KQB2

KS
KX

KM

KF

M

H/DL
L/LL

KC

KK

KK130

DM

KDM

KB

KR

KA

KQG2

KG

KFG2

MS

KKA

KP

LQ

MQR

T



1 Gasket Material Modification

Symbol	Specifications	
X83	Gasket material: Stainless steel 304, NBR	
	Applicable thread	Gasket part no.
	M5	M-5G2
X112	Gasket material: Stainless steel 316, Special FKM	
	Applicable thread	Gasket part no.
	M5	M-5G3

Suffix "-X83" to the end of part number.

Example) **MS-5AU-4-X83**

Spare Parts

Description	Part no.	Applicable thread	Material	Applicable model
Gasket	M-5G1	M5	PVC	—
	M-5G2		Stainless steel 304, NBR	—
	M-5G3		Stainless steel 316, Special FKM	—
	M-5GH		Nylon 66, GF30%	MS-5ALHU-6
				MS-5HLH-4 MS-5HLH-6 MS-5ATHU-6
Cap nut	MS-5-4-P01	—	Stainless steel 316	MS-5H-4 MS-5HL-4 MS-5HLH-4
	MS-5-6-P01	—	Stainless steel 316	MS-5H-6 MS-5HL-6 MS-5HLH-6

⚠ Precautions

- Be sure to read before handling.
- Refer to front matter 56 for Safety Instructions and pages 13 to 16 for Fittings and Tubing Precautions.

Tightening of M5 Thread

⚠ Caution

- Tighten by hand, and give it an additional rotation with a wrench.
Please check the number of tightening revolutions using the table below. If tightened excessively, thread portion may be damaged and gasket may be deformed. This will cause air leakage. On the contrary, if tightened insufficiently, thread may loosen causing air leakage.

Thread	Model	Number of tightening rotations
M5	MS-5AU-□	Approx. 1/6 to 1/4 rotation ^{Note)}
	MS-5H-□	
	MS-5P	
	MS-5J	
	MS-5N	
	MS-5UN	
	MS-5ALHU-6	Approx. 1/2 rotation ^{Note)}
	MS-5HLH-□	
	MS-5ATHU-6	
	MS-5ALHU-3, 4	
	MS-5UL	
	MS-5UT	
	MS-5ATHU-3, 4	

^{Note)} As a guideline, the tightening torque should be 1 to 1.5 N·m.

Use of Tube with Hose Nipple

⚠ Caution

- Cut the tube perpendicularly to the tube axis to a little longer length than required (use tube cutter "TK-1", "TK-2" or "TK-3").
- Pass the tube through the cap nut.
- Push the tube until it comes to the end of the barb portion, or it may cause air leakage or hose releasing.
- Tighten the cap nut firmly by hand on the fitting.

Use of Tube with Barb Fitting

⚠ Caution

- Cut the tube perpendicularly to the tube axis to a little longer length than required (use tube cutter "TK-1", "TK-2" or "TK-3").
- Push the tube until it comes to the end of the barb portion, or it may cause air leakage or release hose.