

Air Slide Table/High Rigidity Type

ø32



A linear guide with a 4-row circular arc groove for high rigidity and high precision

**Table displacement:
Reduced by 50%**

* 0.022 mm → 0.011 mm

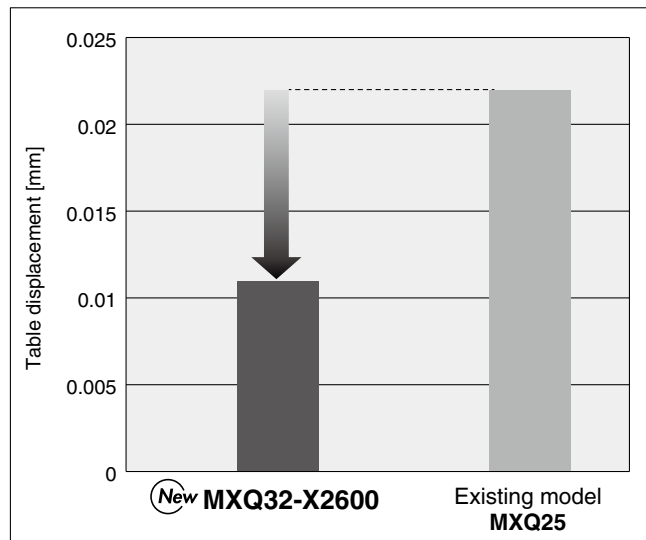

* Displacement of part F (indicated in the figure on the right) when 100 N of load is applied to part F during a 30 mm stroke
 * In accordance with SMC's test conditions
 * Refer to page 4 for details on table displacement.

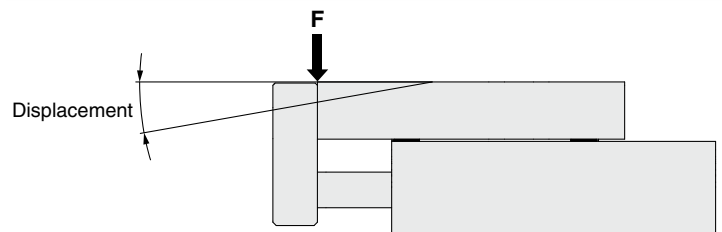
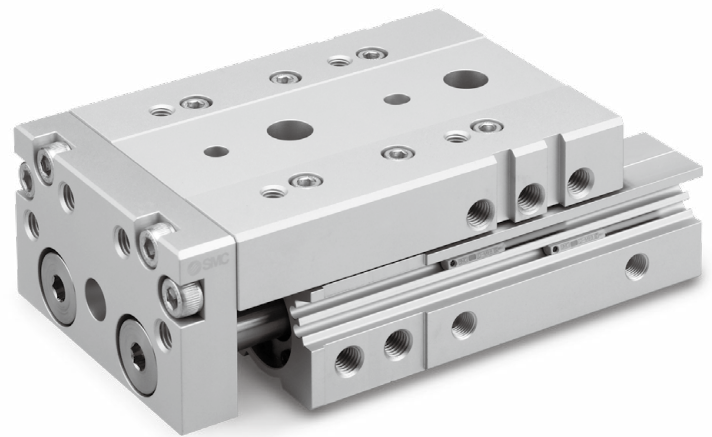

* Measurement at extension stroke end

New ■ 75, 100, 125, and 150 mm strokes have been added.

- **Max. load weight: 16 kg**
- **Aluminum table:
Load weight increased by reducing the weight of moving parts**
- **Integrated pilot port, stroke adjuster, and auto switch on 1 side allows for improved operability**

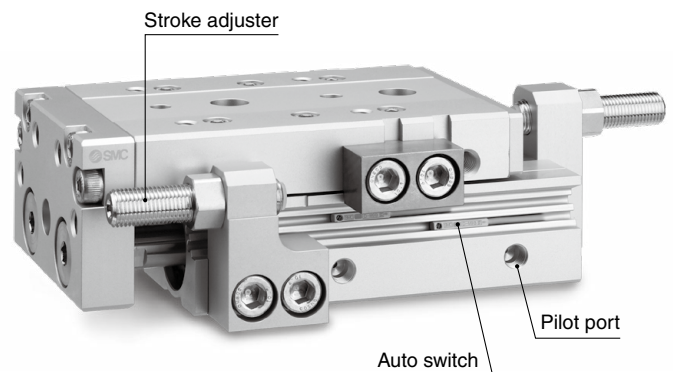

MXQ32-X2600



Air Slide Table/High Rigidity Type

MXQ32-X2600

∅32



How to Order

MXQ 32 - 30 AS - M9BW - [] - [] - X2600

Bore size

Standard stroke [mm]

10, 20, 30, 40, 50, 75, 100, 125, 150

Adjuster option

Symbol	Adjuster type	Adjuster mounting position	
		Extension stroke end	Retraction stroke end
Nil	Without adjuster	—	—
AS	Rubber stopper	●	—
AT		—	●
A		●	●
BS		●	—
BT	Shock absorber/RJ	—	●
B		●	●
ASBT	Extension stroke end rubber stopper + Retraction stroke end shock absorber	●	●
BSAT	Extension stroke end shock absorber + Retraction stroke end rubber stopper	●	●

- * Refer to pages 9 and 10 for the adjuster adjustment range.
- * The "-X12" long adjustment bolt specification is not available for the 10 mm standard stroke type.

Made to order

Nil	None
-X11	Long adjustment bolt (10 mm longer adjuster adjustment range)
-X12	Long adjustment bolt (20 mm longer adjuster adjustment range)
-X33	Without built-in auto switch magnet
-X42	Anti-corrosive guide unit
-X42A	Anti-corrosive guide unit + Long adjustment bolt (10 mm longer adjuster adjustment range)
-X42B	Anti-corrosive guide unit + Long adjustment bolt (20 mm longer adjuster adjustment range)

* Refer to page 13 for details.

Number of auto switches

Nil	2
S	1
n	n

Auto switch

Nil	Without auto switch (Built-in magnet)
-----	---------------------------------------

* For applicable auto switches, refer to the table below.

Applicable Auto Switches/Refer to the Web Catalog for further information on auto switches.

Type	Special function	Electrical entry	Indicator light	Wiring (Output)	Load voltage		Auto switch model		Lead wire length [m]				Pre-wired connector	Applicable load		
					DC	AC	Perpendicular	In-line	0.5 (Nil)	1 (M)	3 (L)	5 (Z)				
Solid state auto switch	—	Grommet	Yes	3-wire (NPN)	24 V	5 V, 12 V	—	M9NV	M9N	●	●	●	○	○	IC circuit	Relay, PLC
				3-wire (PNP)				M9PV	M9P	●	●	●	○			
	2-wire			5 V, 12 V	M9BV	M9B	●	●	●	○	○					
	3-wire (NPN)				M9NVV	M9NV	●	●	●	○						
	Diagnostic indication (2-color indicator)			3-wire (PNP)	M9PVV	M9PV	●	●	●	○	○					
				2-wire	M9BVV	M9BV	●	●	●	○						
	Water resistant (2-color indicator)			—	3-wire (NPN)	5 V, 12 V	M9NAV*1	M9NA*1	○	○	●	○	○			
					3-wire (PNP)		M9PAV*1	M9PA*1	○	○	●	○				
2-wire		M9BAV*1	M9BA*1		○	○	●	○	○							
—		A96V	A96		●	●	●	●		○						
Reed auto switch	—	Grommet	Yes	3-wire (Equiv. to NPN)	24 V	12 V	100 V	A93V	A93	●	●	●	●	○*2	—	Relay, PLC
				2-wire				A90V	A90	●	●	●	●	○*2		
				No	—	5 V	—	A96V	A96	●	●	●	●	○	IC circuit	—

*1 Water-resistant type auto switches can be mounted on the above models, but SMC cannot guarantee water resistance.

*2 The load voltage used is 24 VDC.

* Lead wire length symbols: 0.5 m Nil (Example) M9NV
 1 m M (Example) M9NM
 3 m L (Example) M9NL
 5 m Z (Example) M9NZ

* Auto switches marked with a "○" are produced upon receipt of order.

* Since there are applicable auto switches other than those listed above, refer to the Web Catalog for details.

* For details on auto switches with pre-wired connectors, refer to the Web Catalog.

* Auto switches are shipped together with the product but do not come assembled.

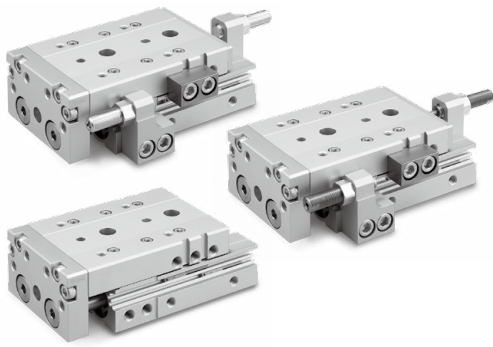

Specifications

Bore size		32
Piping port size		Rc1/8
Fluid		Air
Action		Double acting
Operating pressure		0.15 to 0.7 MPa
Proof pressure		1.05 MPa
Ambient and fluid temperatures		-10 to 60°C (No freezing)
Operating speed range (Average operating speed)		50 to 500 mm/s (50 to 450 mm/s for 125 and 150 mm strokes)
Cushion	Without adjuster	Internal rubber bumper
	With adjuster	Rubber stopper, Shock absorber
Lubrication		Non-lube
Auto switch		Solid state auto switch, Reed auto switch (2-wire, 3-wire) 2-color indicator solid state auto switch (2-wire, 3-wire)
Stroke length tolerance		+2 to 0 mm

* For details on auto switches, refer to the **Web Catalog**.

Adjuster Specifications (Option)

Rubber Stopper

Max. absorbed energy [J]	0.78
Mounting screw size [mm]	M14 x 1.5
Weight [g]	65

Shock Absorber/RJ

Max. absorbed energy [J]	10
Stroke absorption [mm]	12
Operating speed range [mm/s]	50 to 500
Max. operating frequency [cycle/min]	45
Max. allowable thrust [N]	814
Spring force (Extended) [N]	6.4
Spring force (Compressed) [N]	17.4
Mounting screw size [mm]	M14 x 1.5

Theoretical Output

The dual rod ensures an output twice that of existing cylinders.

[N]

Rod size [mm]	Operating direction	Piston area [mm ²]	Operating pressure [MPa]					
			0.2	0.3	0.4	0.5	0.6	0.7
16	OUT	1608	322	483	643	804	965	1126
	IN	1206	241	362	483	603	724	844

Weight

[g]

Standard stroke [mm]							Additional weight of adjuster option	
10, 20, 30	40, 50	75	100	125	150	Extension stroke end	Retraction stroke end	
3400	3600	4500	4950	6200	6650	360	250	

MXQ32-X2600

Weight of Moving Parts

Standard stroke [mm]						Additional weight of adjuster option [g]	
10, 20, 30	40, 50	75	100	125	150	Extension stroke end	Retraction stroke end
1600	1780	2150	2400	2900	3120	140	75

Maximum Load Weight

Without adjuster	Adjuster option [kg]		
Internal rubber bumper	Rubber stopper	Shock absorber/RJ	
		Horizontal	Vertical
16	16	16	16

Allowable Kinetic Energy

Without adjuster	Adjuster option [J]		
Internal rubber bumper	Rubber stopper	Shock absorber/RJ	
		Horizontal	Vertical
0.78	0.78	1.9	1.9

* When selecting a model, refer to Model Selection on page 5. Keep in mind that a model cannot be selected with only the allowable kinetic energy.

Table Accuracy (Reference Values)

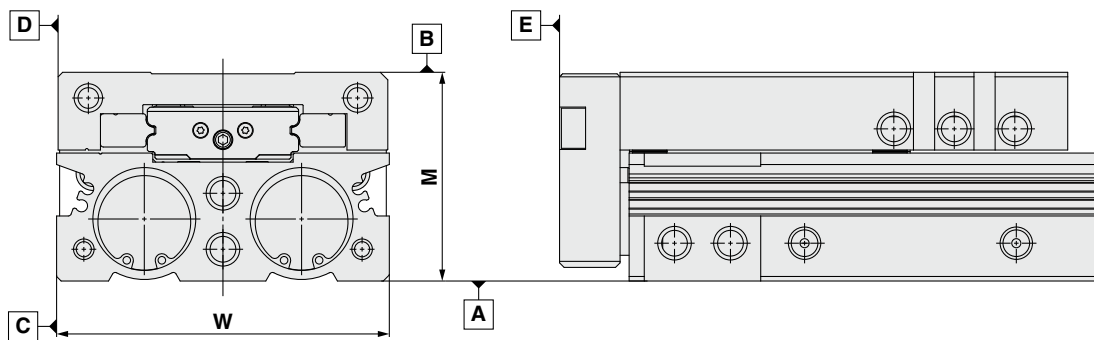

Stroke	10	20	30	40	50	75	100	125	150
B side parallelism to A side	0.085			0.095		0.115		0.125	
D side parallelism to C side	0.075			0.085		0.105		0.115	
B side traveling parallelism to A side	0.015	0.025	0.035	0.045	0.055	0.075	0.090	0.110	0.125
D side traveling parallelism to C side	0.015	0.025	0.035	0.045	0.055	0.075	0.090	0.110	0.125
E side perpendicularity to A side	0.105			0.115		0.125		0.135	
M dimension tolerance	±0.1					±0.12			
W dimension tolerance	±0.1								

Table Displacement (Reference Values)

Table displacement due to pitch moment load

Displacement of part F when a load is applied to part F for the entire stroke

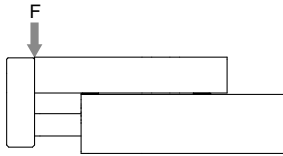

Pitch Moment
MXQ32-10, 20, 30, 40, 50-X2600

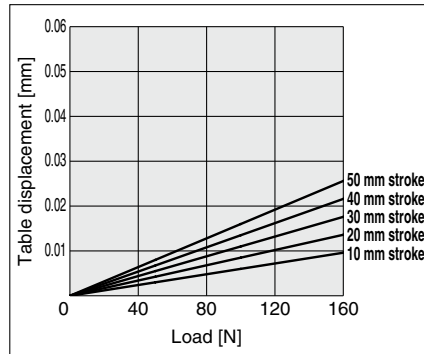

MXQ32-75, 100, 125, 150-X2600

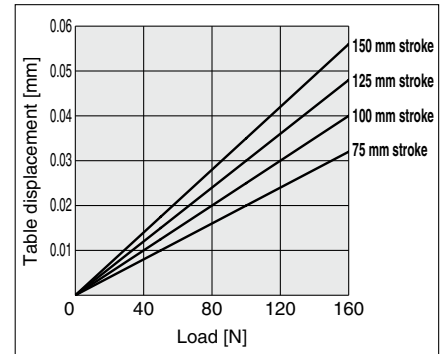
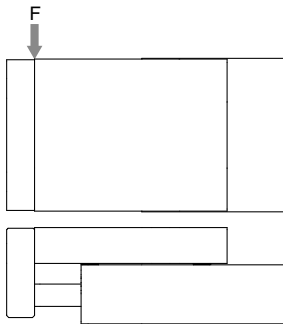
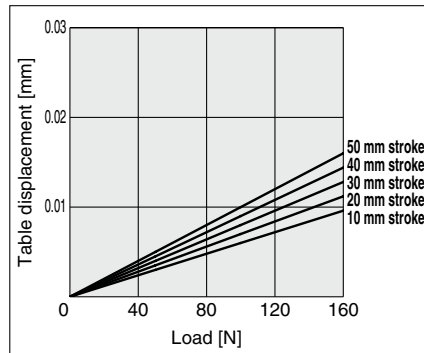

Table displacement due to yaw moment load

Displacement of part F when a load is applied to part F for the entire stroke



Yaw Moment
MXQ32-10, 20, 30, 40, 50-X2600



MXQ32-75, 100, 125, 150-X2600

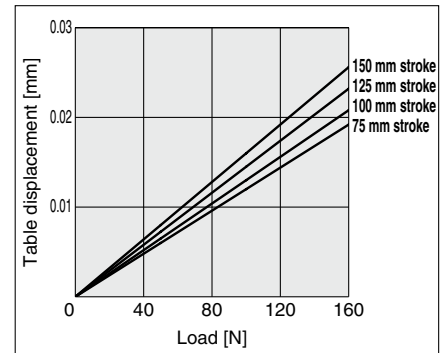
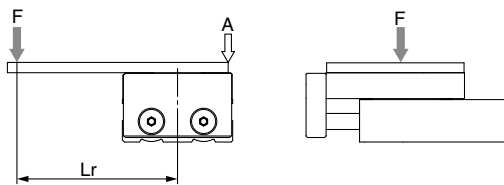
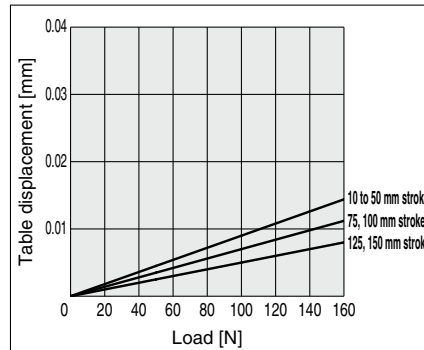

Table displacement due to roll moment load

Displacement of part A when a load is applied to part F with the air slide table retracted



Roll Moment



MXQ32-X2600

Model Selection

Model Selection Software is available.
For details, refer to Model Selection Software on the SMC website.

Selection Conditions

There are two model selection methods according to the usage. The model selection procedures are shown below. The following is a simplified selection procedure using the graphs for when an MXQ is mounted onto a static table.

For Transfer

- (1) Load mass and overhang L_1 and L_2 should be within the average speed (V_a) limit in the graphs.
- (2) For horizontal use, overhang L_3 should not exceed the allowable range. For vertical use, it is not necessary to consider L_3 as it does not affect the moment.

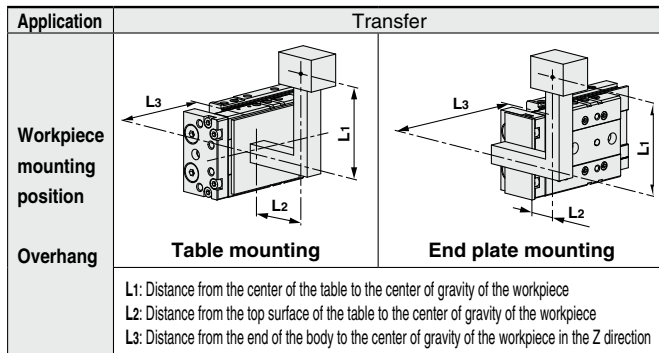

* Positional relationships among L_1 , L_2 , and L_3 do not change regardless of the body mounting direction.

MXQ32-10, 20, 30, 40, 50-X2600

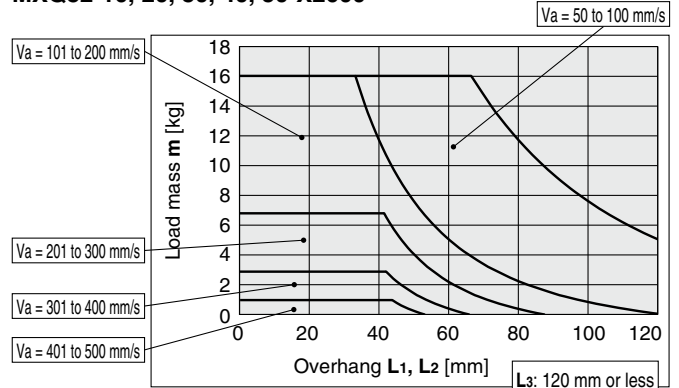

* For end plate mounting, L_2 is 1/2 of the L which is found from the graph.

* Confirm that the overhang L_1 and L_2 are within the allowable range based on the load mass and average speed.

Model Selection Steps

1 Necessary conditions

- Stroke to be used
- Load mass
- Overhang
- Average speed
- Adjuster type

2 Select a graph.

Select the applicable graph by stroke to be used and adjuster type.

When the extension stroke end and retraction stroke end use different adjuster types, check each adjuster graph to see if the adjuster can be used.

3 Determine the overhang.

Determine the overhang at the workpiece mounting positions L_1 , L_2 , and L_3 .

* Positional relationships among L_1 , L_2 , and L_3 do not change regardless of the body mounting direction.

4 Check the overhang.

Check the overhang for L_{1max} , L_{2max} , and L_{3max} during transfer.

(1) L_{1max} : Check the overhang from the cross point of the load mass and driving speed.

(2) L_{2max} : a: When mounted to the table

Check the allowable overhang from the cross point of the load mass and driving speed.

b: When mounted to the end plate

The allowable overhang is found by multiplying the allowable overhang by 1/2.

(3) L_{3max} : It is possible to use within the value in the selection graph if it is within the allowable range of the load mass and driving speed.

5 Overhang in the operating conditions

This product can be used with the overhang required (L_1 , L_2 , L_3 of No. 3) if it is within the allowable overhang range (L_{1max} , L_{2max} , L_{3max} of No. 4).

* When the required overhang exceeds the allowable overhang, review the overhang, load mass, driving speed, etc., and reconfirm that they are acceptable.

MXQ32-10, 20, 30, 40, 50-X2600

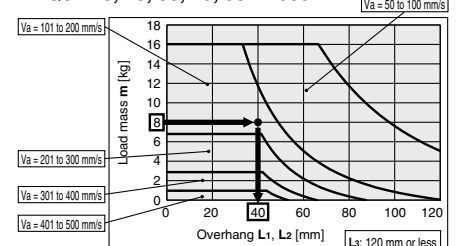

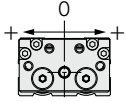

The allowable overhang L_1 for the type without an adjuster is symmetrical. Use in either direction.

For Transfer/Without Adjuster

MXQ32-10, 20, 30, 40, 50-X2600

$V_a = 50$ to 100 mm/s

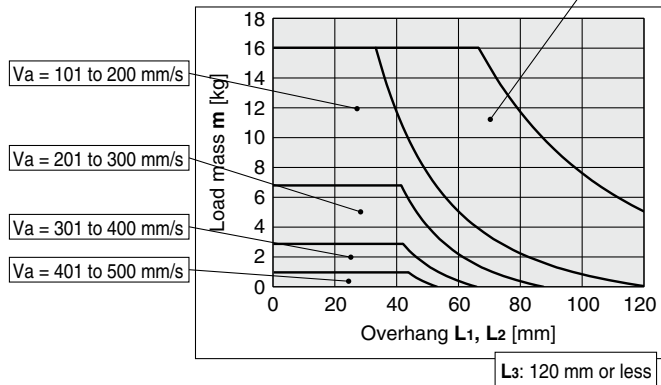

* For end plate mounting, L_2 is 1/2 of the L which is found from the graph.

MXQ32-75, 100-X2600

$V_a = 50$ to 100 mm/s

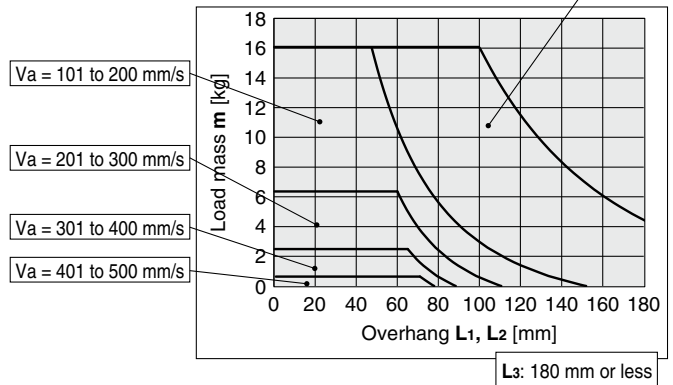

* For end plate mounting, L_2 is 1/2 of the L which is found from the graph.

MXQ32-125, 150-X2600

$V_a = 50$ to 100 mm/s
 $L_2 = 140$ mm or less

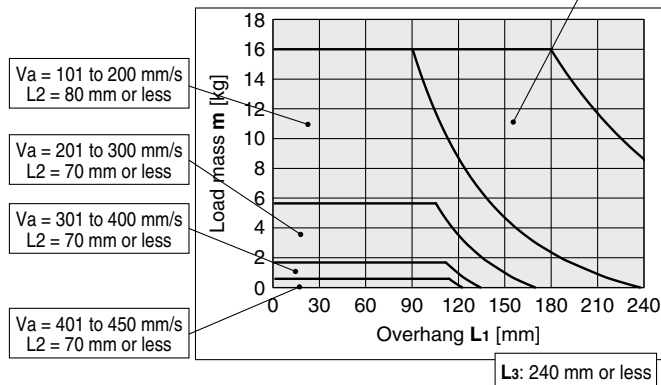

* For end plate mounting, L_2 is 1/2.

MXQ32-X2600

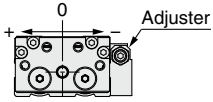

The allowable overhang L₁ for the adjuster type is asymmetrical. The adjuster side is the “-” direction.

For Transfer/Rubber Stopper

With rubber stopper **AS**: Extension stroke end

MXQ32-10, 20, 30, 40, 50AS-X2600

V_a = 50 to 100 mm/s
L₂ = 120 mm or less

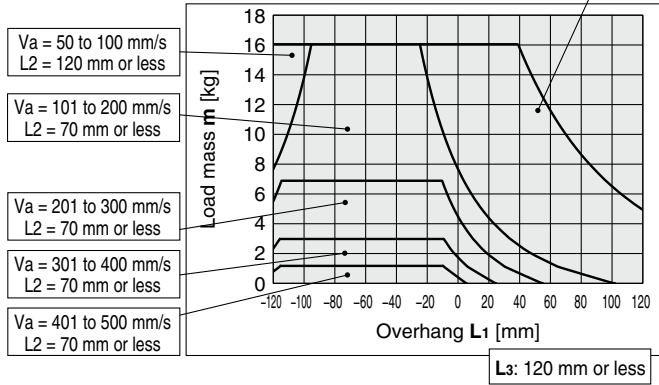

* For end plate mounting, L₂ is 1/2.

MXQ32-75, 100AS-X2600

V_a = 50 to 100 mm/s
L₂ = 150 mm or less

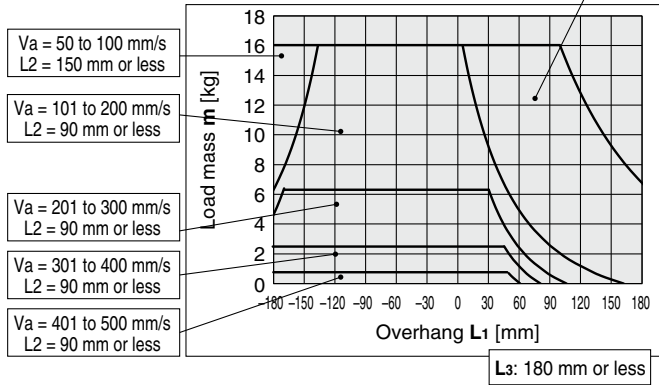

* For end plate mounting, L₂ is 1/2.

MXQ32-125, 150AS-X2600

V_a = 50 to 100 mm/s
L₂ = 200 mm or less

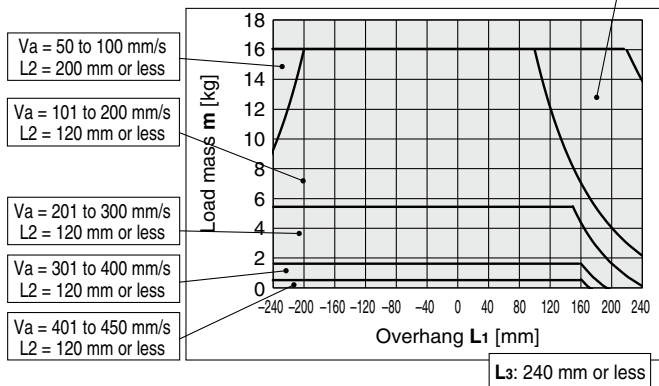

* For end plate mounting, L₂ is 1/2.

With rubber stopper **AT**: Retraction stroke end

MXQ32-10, 20, 30, 40, 50AT-X2600

V_a = 50 to 100 mm/s
L₂ = 120 mm or less

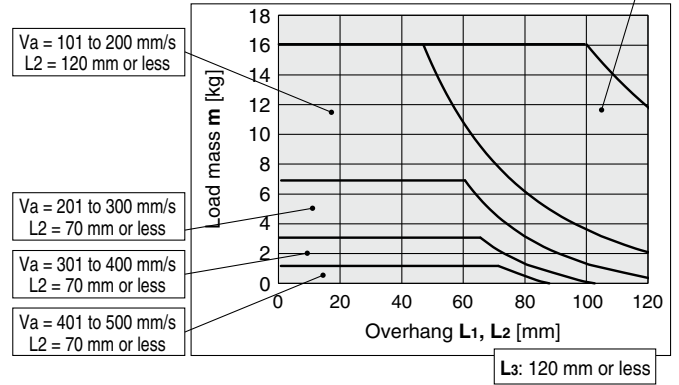

* For end plate mounting, L₂ is 1/2.

MXQ32-75, 100AT-X2600

V_a = 50 to 100 mm/s
L₂ = 150 mm or less

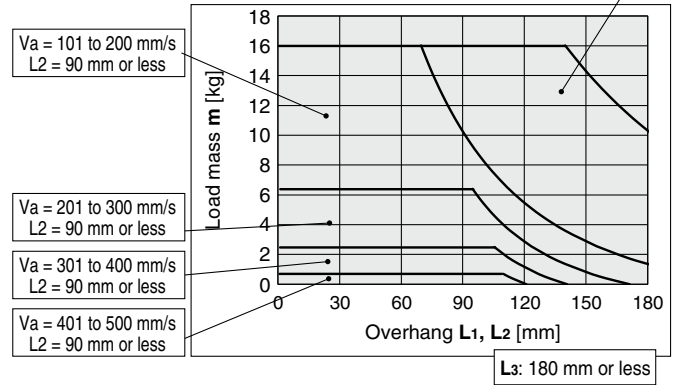

* For end plate mounting, L₂ is 1/2.

MXQ32-125, 150AT-X2600

V_a = 50 to 100 mm/s
L₂ = 200 mm or less

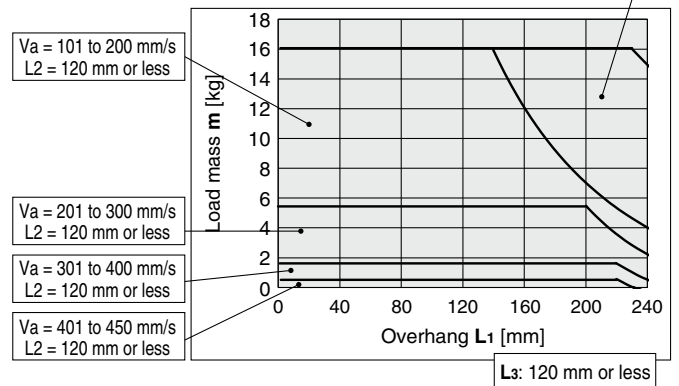

* For end plate mounting, L₂ is 1/2.

For Transfer/Shock Absorber

Shock absorber **BS**: Extension stroke end

MXQ32-10, 20, 30, 40, 50BS-X2600 Va = 50 to 200 mm/s

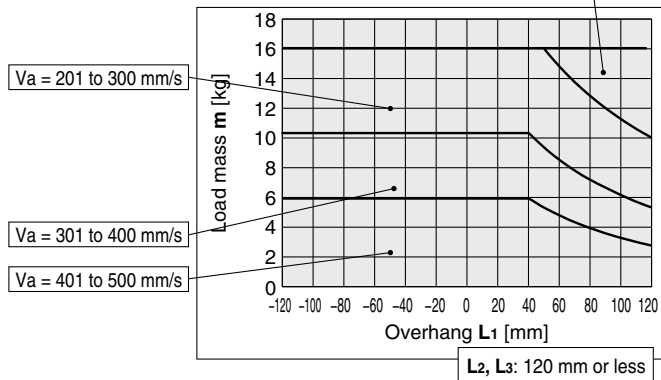

* For end plate mounting, L₂ is 1/2.

MXQ32-75, 100BS-X2600 Va = 50 to 200 mm/s

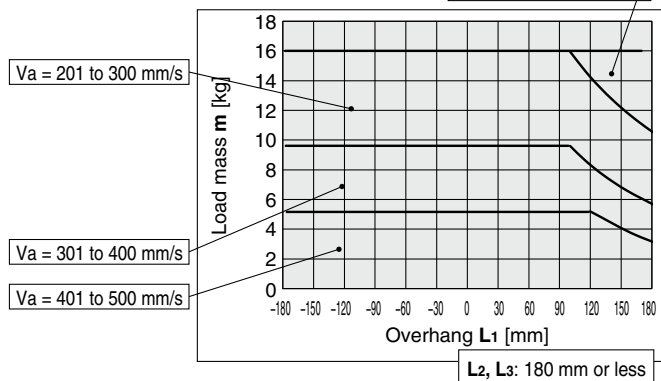

* For end plate mounting, L₂ is 1/2.

MXQ32-125, 150BS-X2600

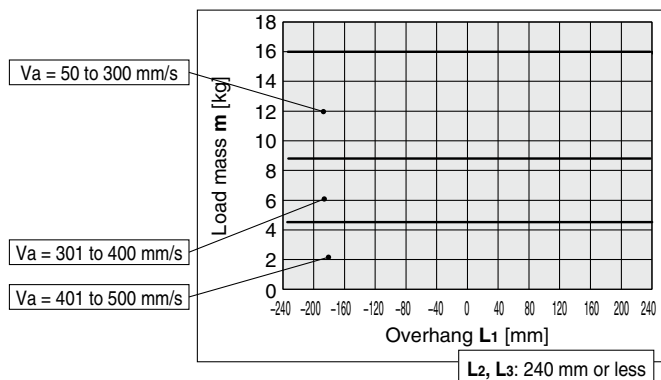

* For end plate mounting, L₂ is 1/2.

Shock absorber **BT**: Retraction stroke end

MXQ32-10, 20, 30, 40, 50BT-X2600 Va = 50 to 200 mm/s

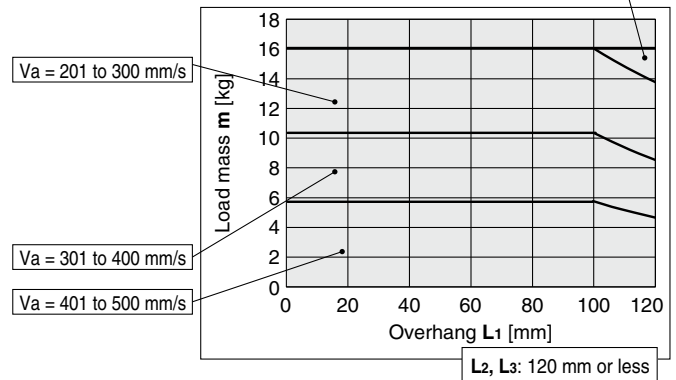

* For end plate mounting, L₂ is 1/2.

MXQ32-75, 100BT-X2600 Va = 50 to 200 mm/s

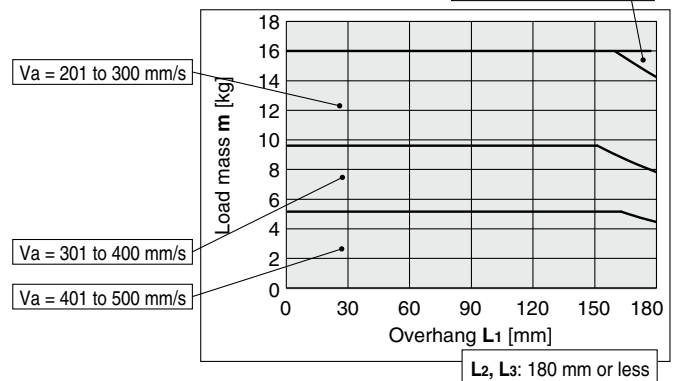

* For end plate mounting, L₂ is 1/2.

MXQ32-125, 150BT-X2600

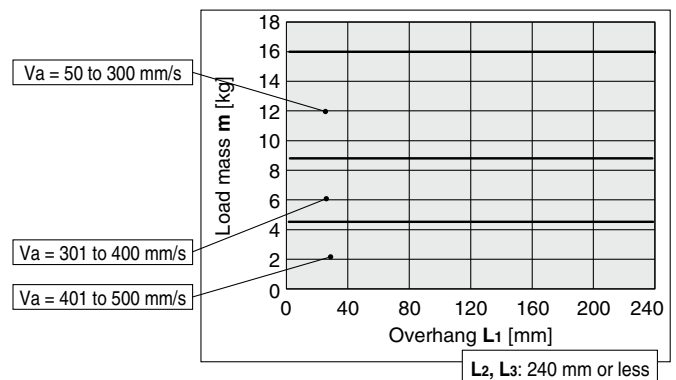

* For end plate mounting, L₂ is 1/2.

⚠ Caution

1. Operate loads within the range of the operating limits.

Select a model according to the model selection steps.

If the product is used outside of the operating limits, adverse effects such as play in the guide, degrading accuracy, and shortened product life may result.

2. If an intermediate stop is performed by an external stopper, be careful of ejection when restarting.

If lurching occurs, damage may result. If a slide table is stopped at an intermediate position by an external stopper and then moved forwards, after the slide table is returned to the back to retract the stopper, supply pressure to the opposite port to operate the slide table.

3. Do not use the product in such a way that excessive external force or impact force is applied to it.

Malfunction or damage to the table may result.

Although the table has adequate strength, if it is damaged, protect your hands with gloves. Otherwise, injury may result.

4. If the speed has been changed after setting the operating conditions, be sure to reconfirm the model selection requirements before use.

If the operating speed is increased after setting the operating conditions such as overhang and operating speed, the stopping impact force will increase, which causes an excessive moment to be generated; this will lead to the failure of the guide.

If the adjusting screw of the speed controller is loosened, the operating speed will increase, so the screw should be tightened completely.

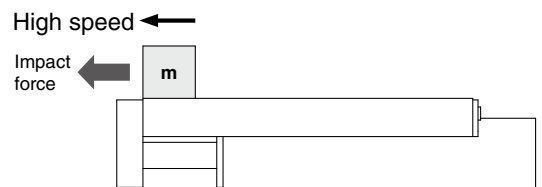

MXQ32-X2600

For Pressing (Clamping)

- (1) Confirm that the clamping attachment weight and overhang are within the allowable range as shown in the graphs for transfer.
- (2) Pressing force N and overhang L_1 and L_2 should be within the range as shown in the graphs.

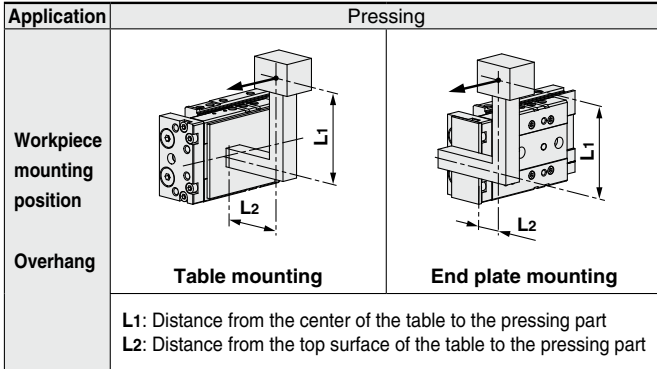

* Positional relationships between L_1 and L_2 do not change regardless of the body mounting direction.

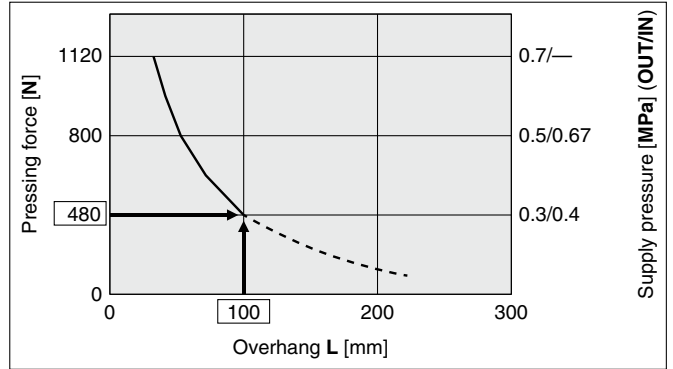

* The allowable supply pressure on the OUT and IN sides is the theoretical output of the cylinder when pressing force is required.
 * Confirm that the intersection of the pressing force and overhang L_1 is within the range as shown in the graph.

Model Selection Steps

1 Necessary conditions

- Stroke to be used
- Required pressing force or operating pressure
- Overhang

2 Select a graph.

Select the graph of the applicable workpiece mounting method.

3 Determine the overhang.

Determine the overhang at the workpiece mounting positions L_1 and L_2 .

* Positional relationships between L_1 and L_2 do not change regardless of the body mounting direction.

4 Check the allowable pressing force.

Confirm the allowable pressing force N_{max} with the overhang.

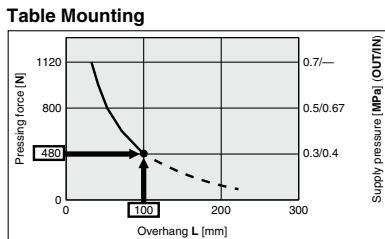

* The allowable supply pressure on the OUT and IN sides is the theoretical output of the cylinder when pressing force is required.

5 Allowable pressing force in the operating conditions

This product must be used within the allowable pressing force range.

* When the required pressing force exceeds the allowable pressing force, review the operating pressing force, operating pressure, overhang, etc., and reconfirm that they are acceptable.

Table Mounting

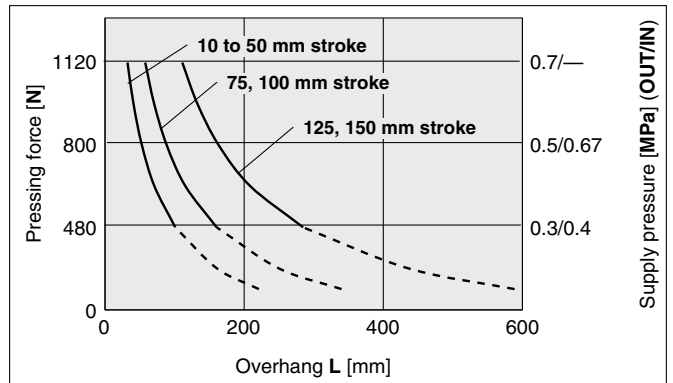

* Refer to this because there are variations in the dotted line area.

End Plate Mounting

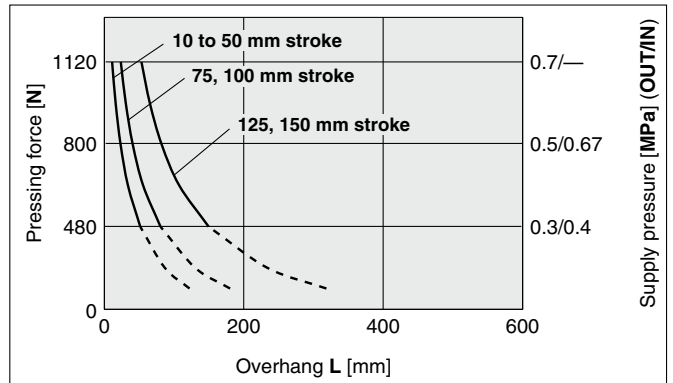

* Refer to this because there are variations in the dotted line area.

Air Slide Table/High Rigidity Type **MXQ32-X2600**

Dimensions: MXQ 32

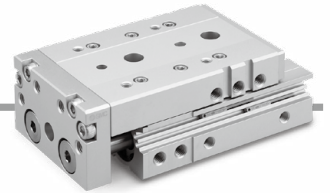

Basic type

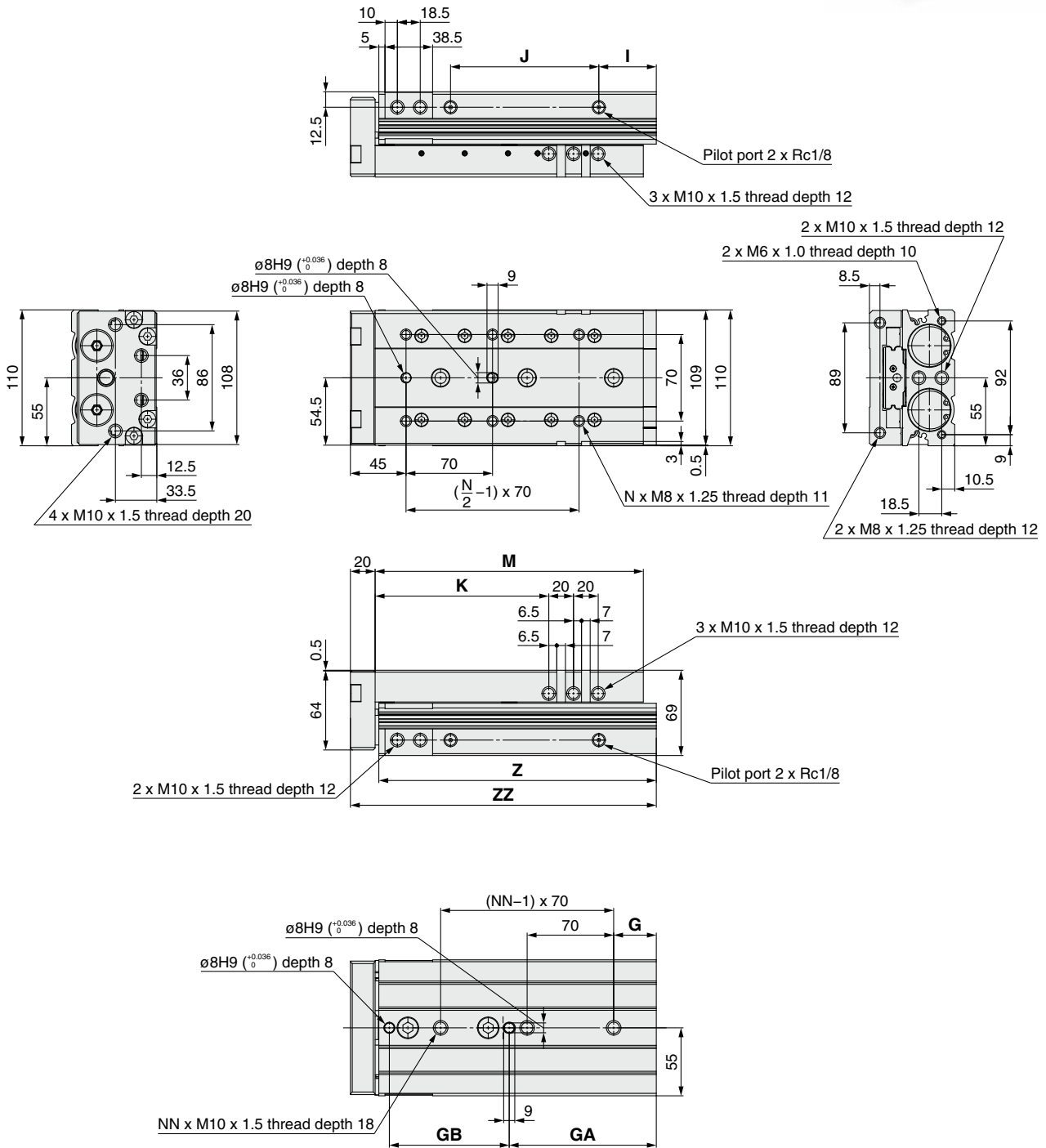

Model	G	N	NN	GA	I	J	K	M	Z	ZZ	GB
MXQ32-10-X2600	25.5	4	2	52	37.5	50	70.5	138	145.5	168.5	85
MXQ32-20-X2600											
MXQ32-30-X2600											
MXQ32-40-X2600	35.5	4	2	62	27.5	70	90.5	148	155.5	178.5	
MXQ32-50-X2600											
MXQ32-75-X2600	79.5	6	2	94	46.5	95	115.5	192	199.5	222.5	
MXQ32-100-X2600	34.5	6	3	119	46.5	120	140.5	217	224.5	247.5	
MXQ32-125-X2600	26.5	8	4	133	83.5	145	165.5	279	286.5	309.5	
MXQ32-150-X2600	48.5	8	4	155	80.5	170	190.5	301	308.5	331.5	145

[mm]

MXQ32-X2600

Dimensions: MXQ **32** [Adjuster Option]

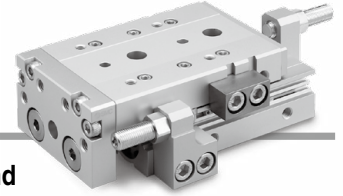

With rubber stopper **A**: Both ends, **AS**: Extension stroke end, **AT**: Retraction stroke end

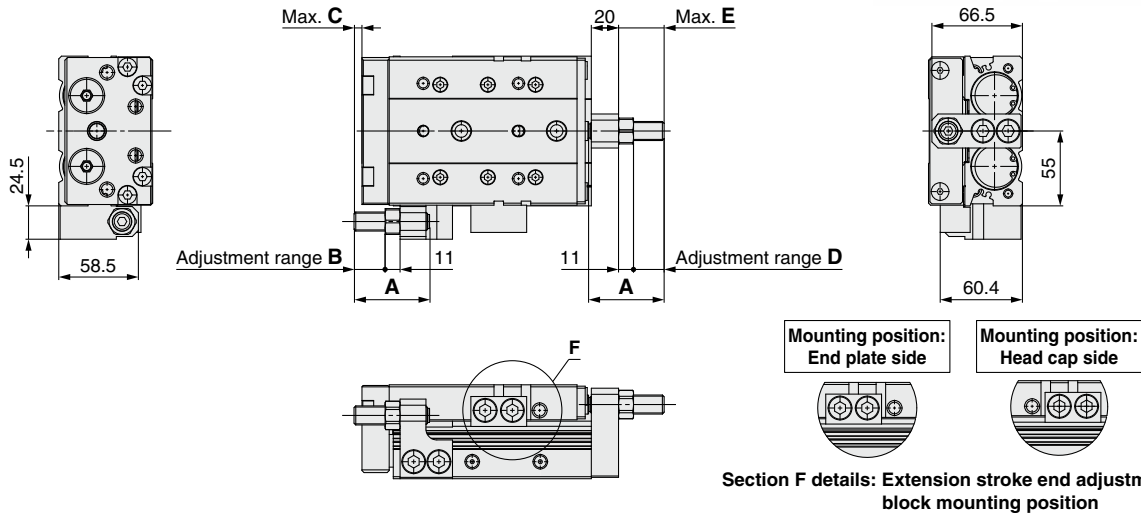

Section F details: Extension stroke end adjustment block mounting position

Applicable stroke	MXQ32-□□A, AS, AT-X2600 [mm]				
	A	Adjustment block mounting position		D	E
		End plate side	Head cap side		
10	65.5	10	0	30	44.5
20	55.5	10	0	20	34.5
30		20	5.5		
40		10	0		
50		—	—		
75	—	—	—	—	—
100	20	5.5	—	—	—
125	—	—	—	—	—
150	—	—	—	—	—

Applicable stroke	MXQ32-□□A, AS, AT-X11-X2600 [mm]				
	A	Adjustment block mounting position		D	E
		End plate side	Head cap side		
10	75.5	20	5.5	40	54.5
20	65.5	20	5.5	30	44.5
30		30	15.5		
40		20	5.5		
50		—	—		
75	—	—	—	—	—
100	30	15.5	10	0	—
125	—	—	—	—	—
150	—	—	—	—	—

Applicable stroke	MXQ32-□□A, AS, AT-X12-X2600 [mm]				
	A	Adjustment block mounting position		D	E
		End plate side	Head cap side		
20	75.5	30	15.5	40	54.5
30		40	25.5		
40		30	15.5		
50		—	—		
75	—	—	—	—	—
100	40	25.5	20	5.5	—
125	—	—	—	—	—
150	—	—	—	—	—

* The adjustable stroke range will change depending on the mounting position of the adjustment block.
 * The "-X12" long adjustment bolt specification is not available for the 10 mm standard stroke type.

Adjuster/Rubber stopper (dimensions)

Extension stroke end

Body mounting

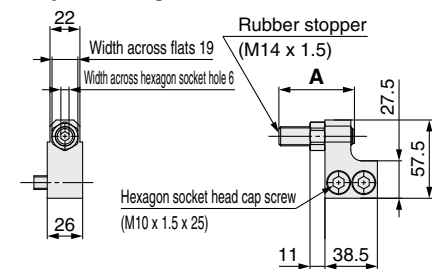
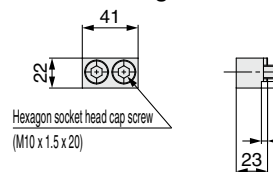

Table mounting



Retraction stroke end

Body mounting

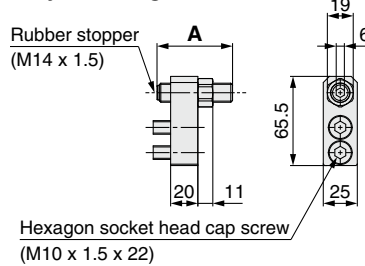
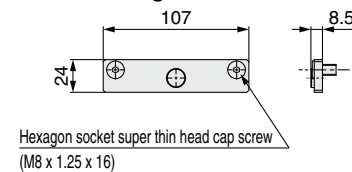
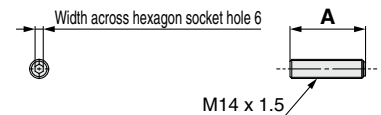

Table mounting



Adjustment bolt/Rubber stopper (Single unit)



Adjuster Part Nos. and Dimensions

Standard stroke	Model			A	
	Extension stroke end	Retraction stroke end	Rubber stopper (Single unit)		
10	Standard	MXQ-AS32-X11-X2600	MXQ-AT32-X11-X2600	MXQA-A2527-X11	65.5
	Long adjustment bolt (-X11)	MXQ-AS32-X12-X2600	MXQ-AT32-X12-X2600	MXQA-A2527-X12	75.5
20, 30, 40, 50, 75, 100, 125, 150	Standard	MXQ-AS32-X2600	MXQ-AT32-X2600	MXQA-A2527	55.5
	Long adjustment bolt (-X11)	MXQ-AS32-X11-X2600	MXQ-AT32-X11-X2600	MXQA-A2527-X11	65.5
	Long adjustment bolt (-X12)	MXQ-AS32-X12-X2600	MXQ-AT32-X12-X2600	MXQA-A2527-X12	75.5

* Adjusters for the 10 mm standard stroke type use the "-X11" long adjustment bolt specification as standard, and the "-X11" long adjustment bolt specification uses the "-X12" long adjustment bolt specification.

Dimensions: MXQ **32** [Adjuster Option]

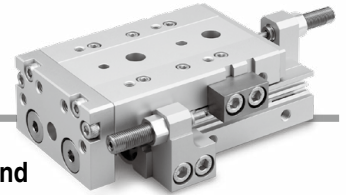

With shock absorber **B**: Both ends, **BS**: Extension stroke end, **BT**: Retraction stroke end

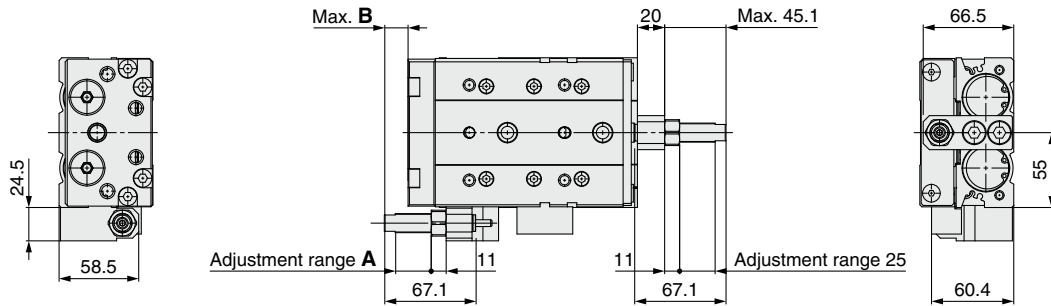

MXQ32-□□B, BS, BT-X2600 [mm]

Applicable stroke	Adjustment block mounting position			
	End plate side		Head cap side	
	A	B	A	B
10	5	0	—	—
20	15	7.1	—	—
30	25	17.1	5	0
40	15	7.1	—	—
50				
75				
100	25	17.1	5	0
125				
150				

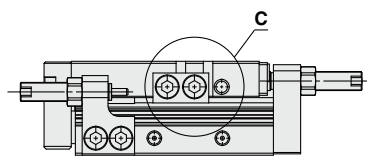

Mounting position: End plate side

Mounting position: Head cap side

Section C details: Extension stroke end adjustment block mounting position

* The adjustable stroke range will change depending on the mounting position of the adjustment block.

Shock absorber (dimensions)

Extension stroke end

Body mounting

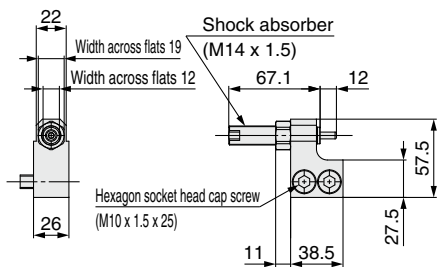

Retraction stroke end

Body mounting

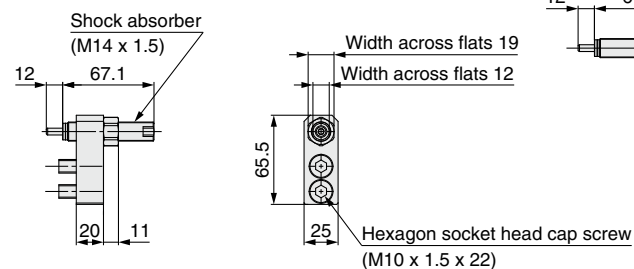

Shock absorber (Single unit)

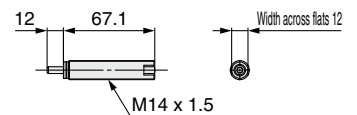

Table mounting

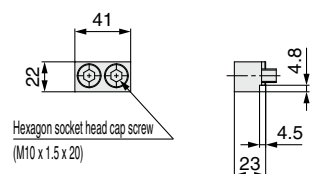
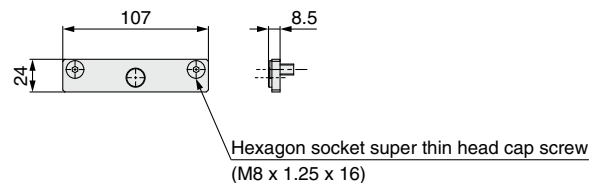

Table mounting



Model		
Extension stroke end	Retraction stroke end	Shock absorber (Single unit)
MXQ-BS32-X2600	MXQ-BT32-X2600	RJ1412LN

MXQ32-X2600

Replacement Parts

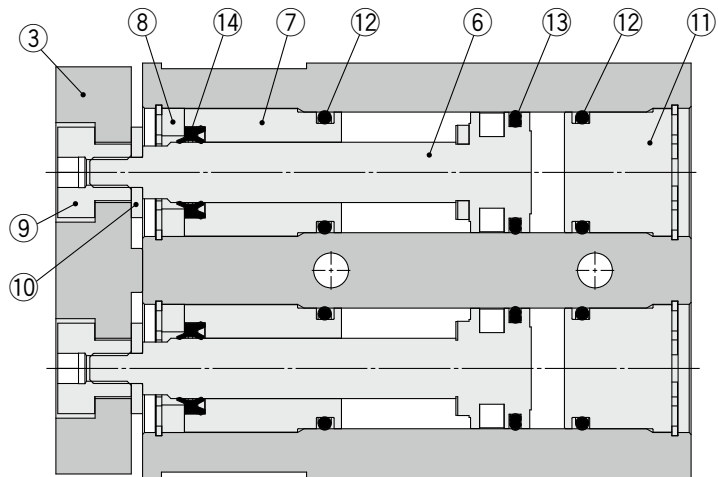
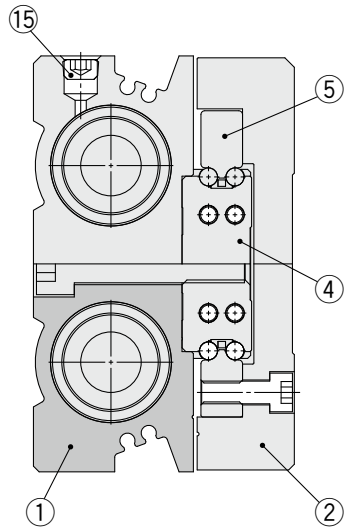

Component Parts

No.	Description
1	Body
2	Table
3	End plate
4	Guide block
5	Guide rail
6	Piston assembly
7	Rod cover
8	Seal support
9	Floating bushing A
10	Floating bushing B
11	Head cap
12	O-ring
13	Piston seal
14	Rod seal
15	Hexagon socket head taper plug

Replacement Parts

Description	Kit no.	Contents
Seal kit	MXQ32-PS	Set of nos. above 12, 13, 14
Plug kit	MXQ-PLG	Set of nos. above 15

Grease Pack Part No.

Applied unit	Grease pack part no.
Guide unit	GR-S-010 (10 g)
	GR-S-020 (20 g)
Cylinder unit	GR-L-005 (5 g)
	GR-L-010 (10 g)

MXQ32-X2600 Auto Switch Mounting

Auto Switch Proper Mounting Position (Detection at stroke end)

* Adjust the auto switch after confirming the operating conditions in the actual setting.

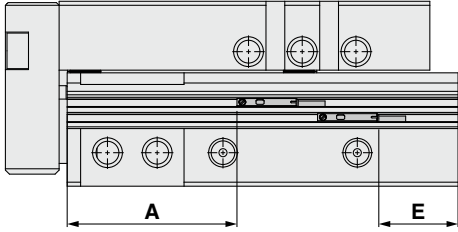

[mm]

Auto switch model	A stroke									E stroke								
	10	20	30	40	50	75	100	125	150	10	20	30	40	50	75	100	125	150
D-M9□/M9□W	76.5	66.5	56.5	66.5	56.5	56.5	56.5	56.5	56.5	36.2	36.2	36.2	26.2	26.2	45.2	45.2	82.2	79.2
D-M9□V/M9□WV	76.5	66.5	56.5	66.5	56.5	56.5	56.5	56.5	56.5	39.2	39.2	39.2	29.2	29.2	48.2	48.2	85.2	82.2
D-M9□A	76.5	66.5	56.5	66.5	56.5	56.5	56.5	56.5	56.5	35	35	35	25	25	44	44	81	78
D-M9□AV	76.5	66.5	56.5	66.5	56.5	56.5	56.5	56.5	56.5	37	37	37	27	27	46	46	83	80
D-A9□/A9□V	72.5	62.5	52.5	62.5	52.5	52.5	52.5	52.5	52.5	41 (38.5)	41 (38.5)	41 (38.5)	31 (28.5)	31 (28.5)	50 (47.5)	50 (47.5)	87 (84.5)	84 (84.5)

* (): Denotes the values of D-A90 and A93

Auto Switch Mounting

⚠ Caution

■ Auto switch mounting direction

If the lead wire is positioned like the drawing on the left, the auto switch may malfunction. Mount the lead wire like the drawing on the right.

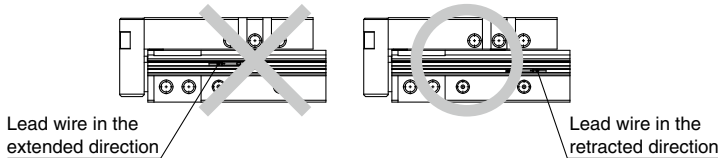

■ Auto switch mounting tool

When tightening the auto switch mounting screw (included with the auto switch), use a watchmaker's screwdriver with a handle diameter of about 5 to 6 mm.

■ Tightening torque

Auto Switch Mounting Screw Tightening Torque [N·m]

Auto switch model	Tightening torque
D-M9□(V) D-M9□W(V) D-A9□(V)	0.05 to 0.15
D-M9□A(V)	0.05 to 0.10

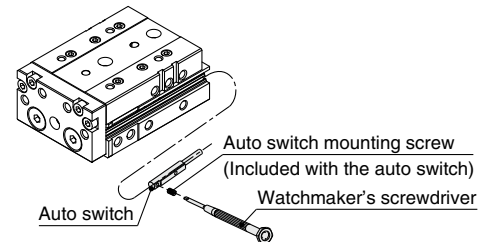

Operating Range

[mm]

Auto switch model	Operating range
D-M9□(V) D-M9□W(V) D-M9□A(V)	5
D-A9□/A9□V	9.5

* Values which include hysteresis are for reference purposes only. They are not a guarantee (assuming approximately ±30% dispersion) and may change substantially depending on the ambient environment.

⚠ Caution

Allow a space of 3 mm or more if a standard type and symmetric type are used side by side. Otherwise, the auto switches may malfunction.

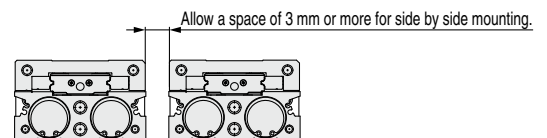

Other than the applicable auto switches listed in "How to Order," the following auto switches are also mountable.

* Normally closed (NC = b contact) solid state auto switches (D-M9□E(V)) and solid state auto switch (D-F8) are also available. For details, refer to the Web Catalog.

MXQ32-X2600

Made to Order

Please contact SMC for detailed dimensions, specifications, and lead times.



1 Long Adjustment Bolt (10 mm longer adjustment range) Symbol **-X11**

Rubber stopper: The stroke adjustment range has been increased by 10 mm compared with the standard product by making the adjustment bolt longer.

* Refer to the dimensions for the rubber stopper adjustment range and dimensions.

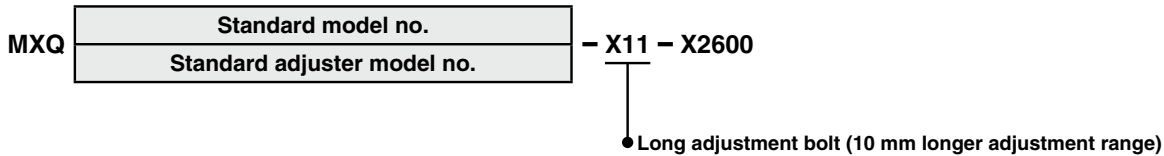

* "-X11" is not available for the shock absorber type.
* When using rubber stoppers, "-X11" applies to both the extension and retraction stroke ends.

2 Long Adjustment Bolt (20 mm longer adjustment range) Symbol **-X12**

Rubber stopper: The stroke adjustment range has been increased by 20 mm compared with the standard product by making the adjustment bolt longer.

* Refer to the dimensions for the rubber stopper adjustment range and dimensions.

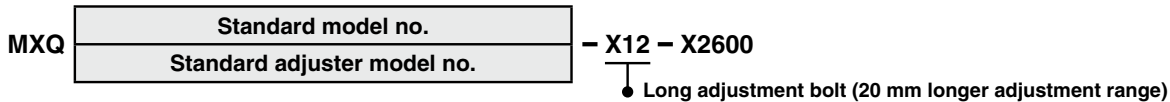

* "-X12" is not available for the shock absorber type.
* When using rubber stoppers, "-X12" applies to both the extension and retraction stroke ends.
* The "-X12" rubber stopper is not available for the 10 mm standard stroke type.

3 Without Built-in Auto Switch Magnet Symbol **-X33**

This product does not have a magnet for an auto switch.
It is suitable for applications where magnetic force is not acceptable.

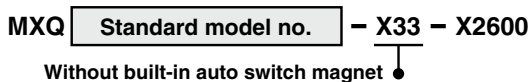

Specifications

Bore size [mm]	32
Auto switch	Not mountable

* Dimensions and specifications other than the above are the same as the standard type.

4 Anti-corrosive Guide Unit Symbol **-X42**

The guide rail and guide block are given anti-corrosive treatment.

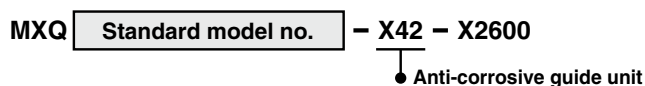

Specifications

Bore size [mm]	32
Surface treatment	Special anti-corrosive treatment*1

*1 The special anti-corrosive treatment makes the guide rail and the guide block black.

* Dimensions and specifications other than the above are the same as the standard type.

5 Anti-corrosive Guide Unit + Long Adjustment Bolt Symbol **-X42A, -X42B**

The guide rail and guide block are given anti-corrosive treatment.

Rubber stopper: The stroke adjustment range has been increased compared with the standard product by making the adjustment bolt longer.

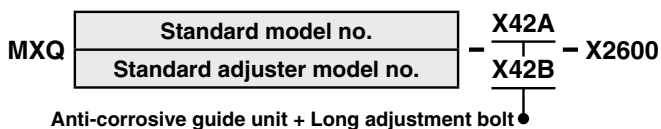

Specifications

Symbol	-X42A	-X42B
Bore size [mm]	32	
Surface treatment	Special anti-corrosive treatment*1	
Long adjustment bolt (Adjustment range)	10 mm longer	20 mm longer

*1 The special anti-corrosive treatment makes the guide rail and the guide block black.

* Dimensions and specifications other than the above are the same as the standard type.

* Refer to the dimensions for the rubber stopper adjustment range and dimensions.
* "-X42A" and "-X42B" are not available for the shock absorber type.
* When using rubber stoppers, "-X42A" and "-X42B" apply to both the extension and retraction stroke ends.
* The "-X42B" rubber stopper is not available for the 10 mm standard stroke type.



MXQ32-X2600

Specific Product Precautions

Be sure to read this before handling the products. For safety instructions, actuator precautions, and auto switch precautions, refer to the “Handling Precautions for SMC Products” and the “Operation Manual” on the SMC website: <https://www.smcworld.com>

Mounting

⚠ Caution

1. The positioning holes on the table and on the bottom of the body do not have the same center. Use these holes during reinstallation after the table has been removed for the maintenance of an identical product.
2. When the adjuster is mounted, a moment is generated by the cylinder thrust, causing displacement of the table end at stop. The displacement amount may vary depending on the supply pressure, mounting orientation, or model.

Operating Environment

⚠ Caution

1. Martensitic stainless steel is used for the guide rail, and high carbon chromium steel (high carbon chromium bearing steel) is used for the guide block. However, the anti-corrosiveness of these steels is inferior to that of austenitic stainless steel. In particular, rust may be generated in environments where water droplets are likely to adhere due to condensation, etc.
2. Use caution for the anti-corrosiveness of the linear guide section.
In particular, rust may be generated in environments where water droplets are likely to adhere due to condensation, etc.

Other

⚠ Warning

1. Do not put your hands or fingers between the table and bracket.

Never put hands or fingers in the gap between the table and bracket when retracted. Doing so will result in injury.

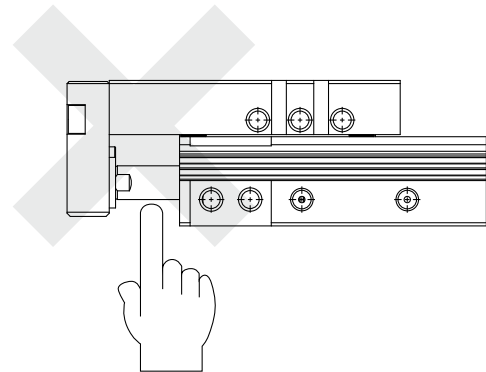

2. Be aware that smoking cigarettes, etc., after your hands have come into contact with the grease used in the cylinder section of this product can create a gas that is hazardous to humans.

⚠ Caution

1. Do not disassemble or modify the product.
2. Performance stability

The piston speed in the specification table shows the average speed. The actual speed of this product may vary slightly during the stroke depending on changes in the load resistance or pressure fluctuations.

 **Safety Instructions** Be sure to read the "Handling Precautions for SMC Products" (M-E03-3) and "Operation Manual" before use.

SMC Corporation

Akihabara UDX 15F,
4-14-1, Sotokanda, Chiyoda-ku, Tokyo 101-0021, JAPAN
Phone: 03-5207-8249 Fax: 03-5298-5362
<https://www.smcworld.com>
© 2023 SMC Corporation All Rights Reserved

Specifications are subject to change without prior notice
and any obligation on the part of the manufacturer.

D-G