

# Compact Position Sensor New



## Detects the stroke position of compact actuators such as air grippers



**Repeatability**

**0.1 mm**

Refer to the Specific Product Precautions (page 9).

- Compact sensor head and separate Teach unit
- Same shape as the D-M9□ solid state auto switch

### Analog output

- Voltage output (0 to 10 V, 1 to 5 V)
- Current output (4 to 20 mA)

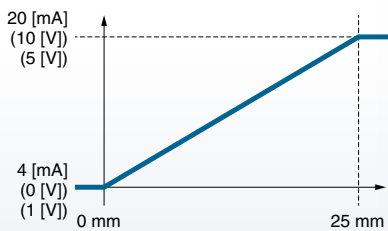

### Switch output

- Set points (ON/OFF positions)
- Normal / Reversed output
- 4 measurement modes
- PNP / NPN output
- 2 outputs (The second output is only for IO-Link.)

### IO-Link compatible

- ON/OFF signals (8 outputs) and position measurement values are transmitted periodically using a single communication line
- Imports the device information and parameter settings using digital communication

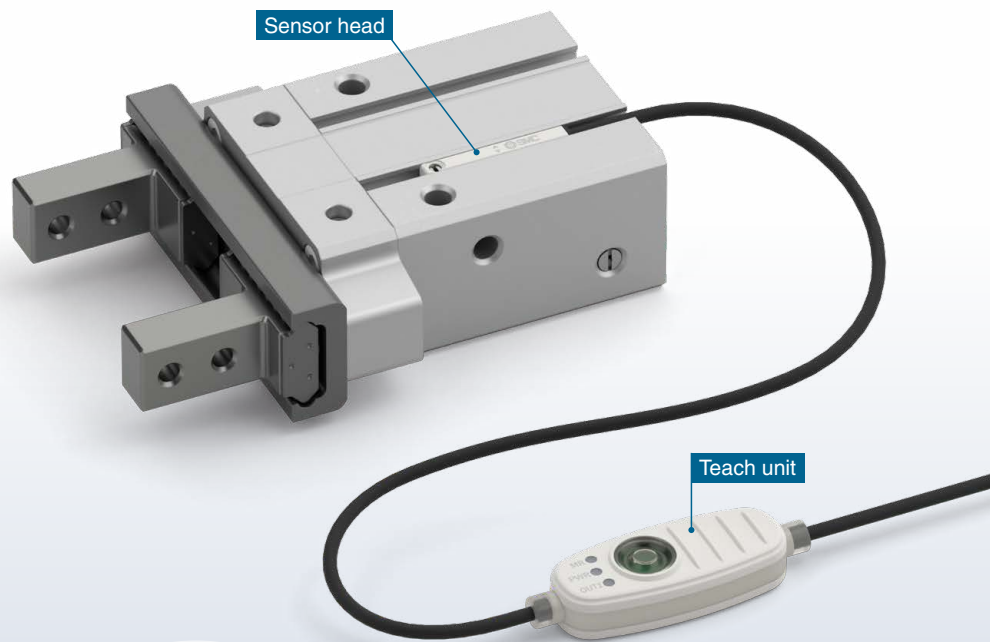

Measurement range: 25 mm



## D-MPG Series

Lineup

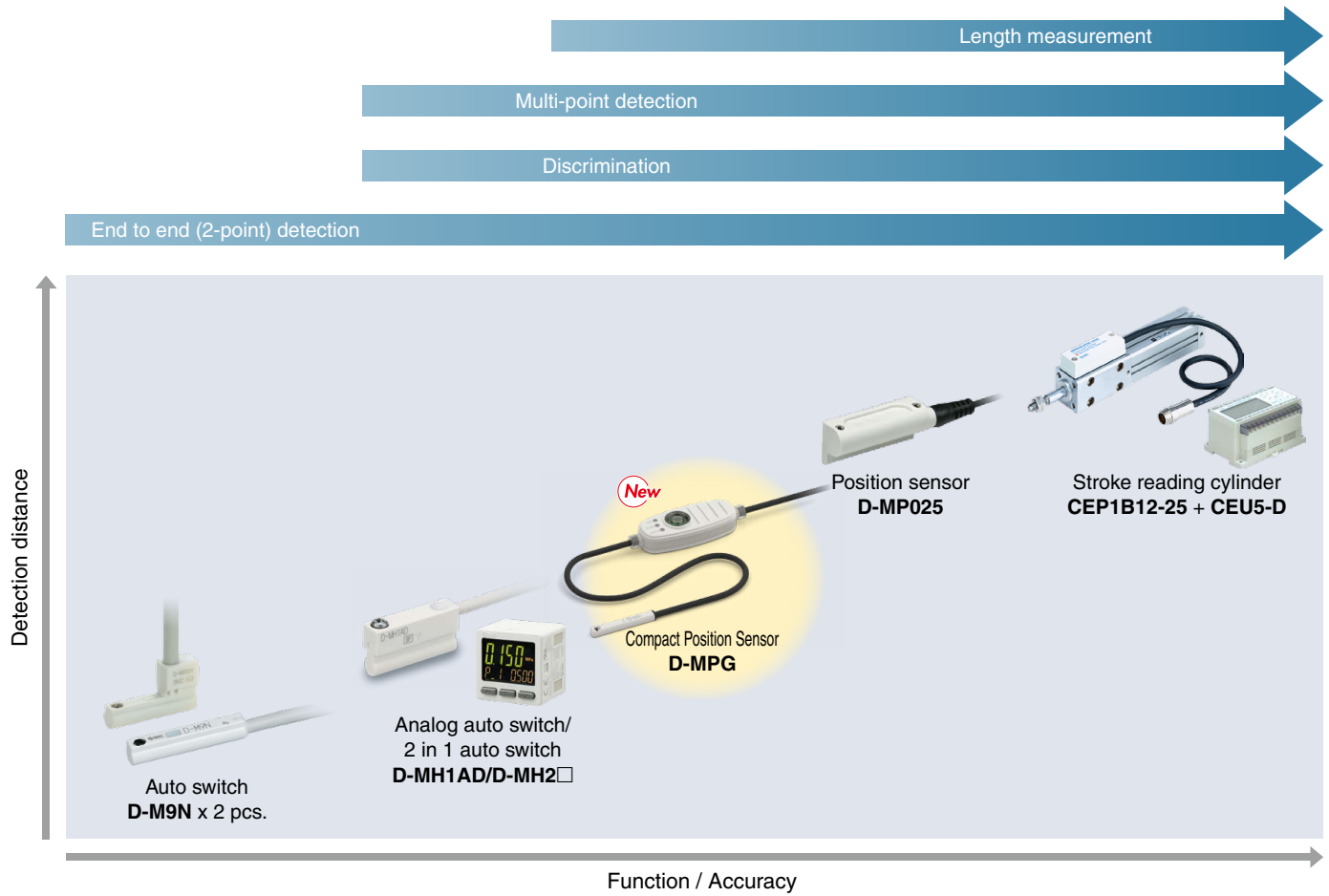

Can be mounted horizontally or vertically

Can be mounted from either direction on the cylinder auto switch mounting groove

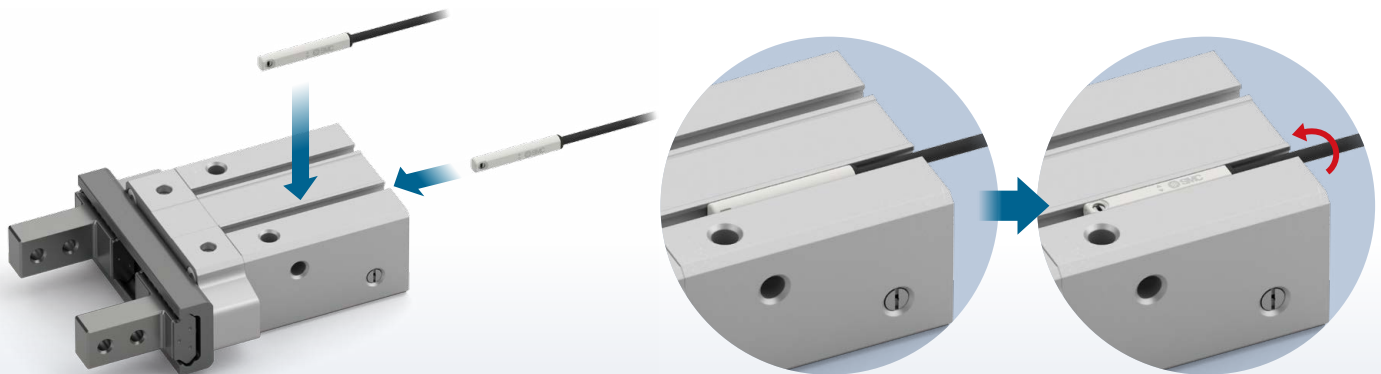

\* After inserting the compact position sensor into the mounting groove, rotate it until the mounting screw surface is facing up.

## Analog output function

- The measurement range can be changed. (After changing the measurement range, it can be reset to the default setting.)
- It is possible to select between analog voltage output (0 to 10 V, 1 to 5 V) and analog current output (4 to 20 mA).
- Analog output can be reversed.

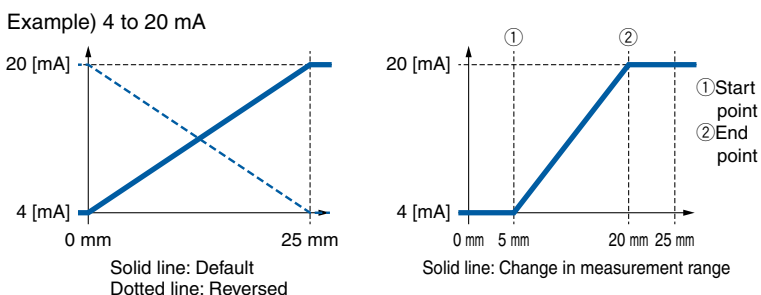

## Operation display

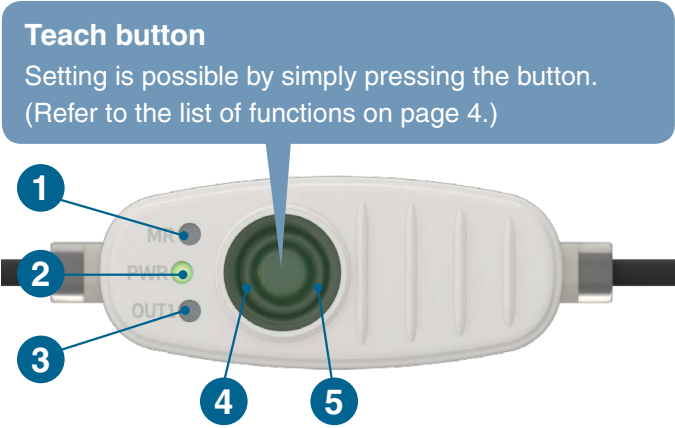

The analog output mode, switch output mode, set point, and stroke range can be set.

Indicator light position	Light indication	Indicator light	Mode
1	ON		Within the measurement range
	OFF		Outside of the measurement range
2	ON		Power ON
	Flashing		IO-Link connection
3	ON		Switch output High, PNP: ON, NPN: OFF
	OFF		Switch output Low, PNP: OFF, NPN: ON
4	ON		Analog current output
5	ON		Analog voltage output

## Lead wire connection

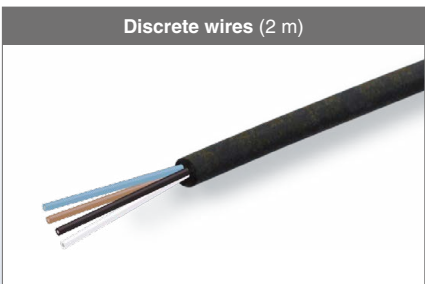

4 switch modes can be selected for the switch output.

**1 Single-point Mode** The output switches when passing through set point 1.

Normal output

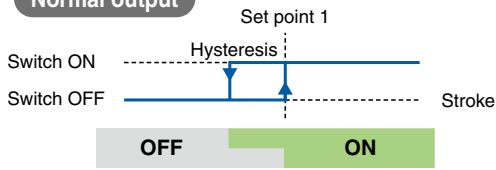

Reversed output

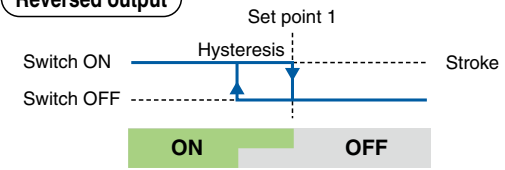

**2 Auto Switch Mode** Set point 1 is at the center of the operating range. The default operating range is 2 mm, but it can be changed to 1, 2, 3, 4, or 5 mm using the teach button. (The operating range can be changed to up to 10 mm for the IO-Link type).

Normal output

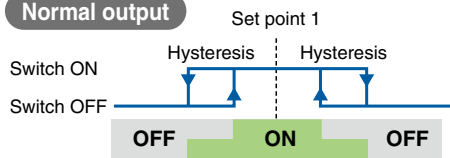

Reversed output

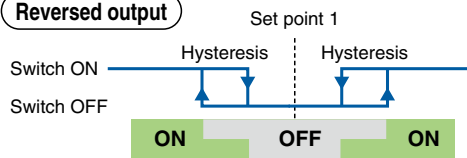

**3 Window Mode** The operating range can be changed by setting set points 1 and 2.

Normal output

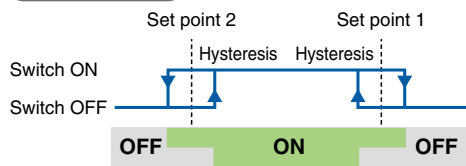

Reversed output

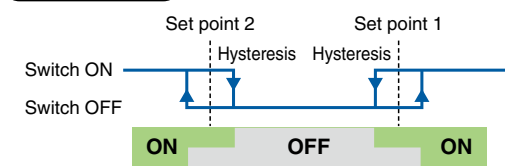

**4 2-Point Mode** Setting is only available in IO-Link mode. Setting of set points 1 and 2 can change the ON and OFF positions.

Normal output

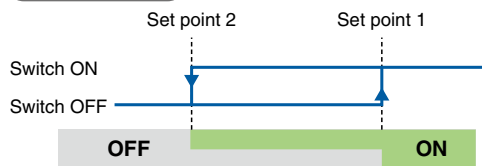

Reversed output

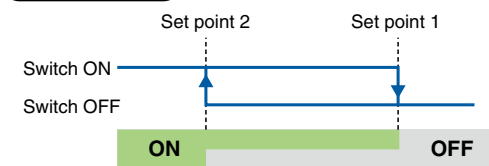

Application example

Alignment and selection of randomly arranged parts  
For identification of workpieces with different dimensions

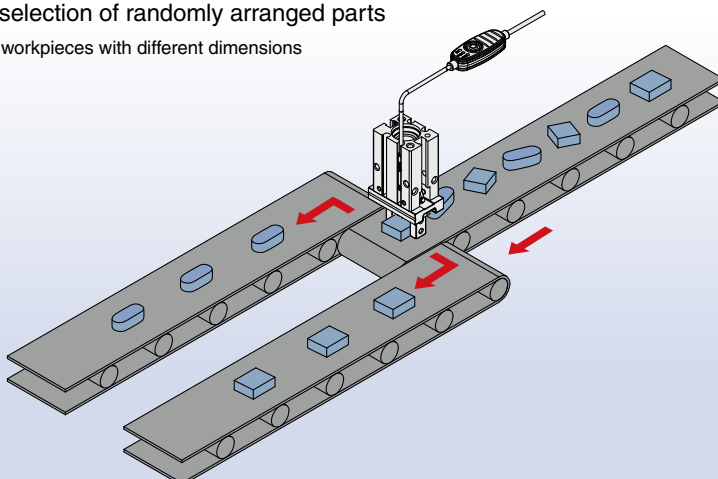

**IO-Link compatible**

Visualize operation status and equipment condition, and enable remote monitoring and operation via communication

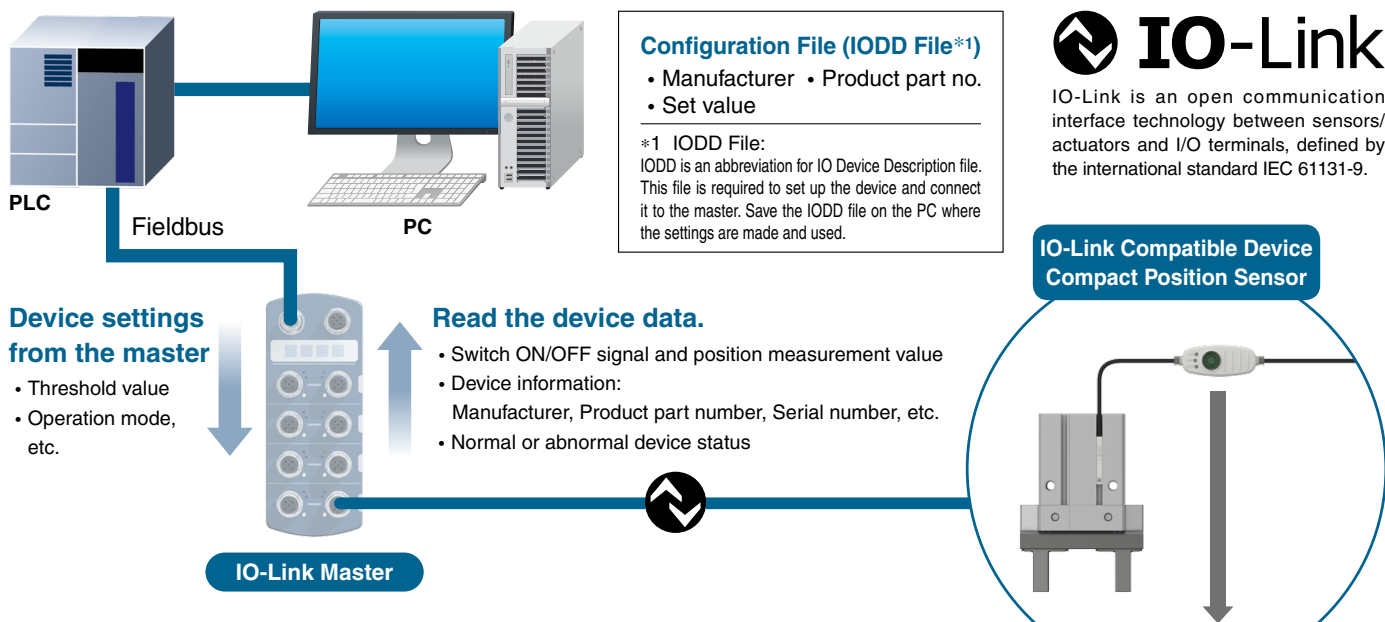

**Compact position sensor IO-Link specifications**

IO-Link version: V1.1  
 Communication speed: 230.4 kbps (COM3)  
 Shortest data update cycle: 1 ms



**Process Data**

Bit offset	31	30	29	28	27	26	25	24	23	22	21	20	19	18	17	16
Item	Position measurement value (PD)															

Bit offset	15	14	13	12	11	10	9	8	7	6	5	4	3	2	1	0
Item	Scale (-5)								OUT8	OUT7	OUT6	OUT5	OUT4	OUT3	OUT2	OUT1

Single-point mode, auto switch mode, window mode, 2-point mode, and normal/reversed output can be individually set at any position for each output (OUT1 to OUT8). "Scale" means 1LSB of PD is 0.01 mm.

**List of Functions**

Function	Teach button setting	IO-Link setting	IO-Link monitoring
Measurement range change	●	●	—
Measurement range reset	●	●	—
Analog output mode change	●	●	—
Reverse analog output	●	●	—
Single-point mode setting	●	●	—
Auto switch mode setting	●	●	—
Window mode setting	●	●	—
2-point mode setting	—	●	—
Switch point reset	—	●	—
Reverse switch output	—	●	—

Function	Teach button setting	IO-Link setting	IO-Link monitoring
Hysteresis setting	—	●	—
Switch output mode reset	●	●	—
Factory reset mode	●	●	—
Calibration*1	●	●	—
Cycle time	—	—	●
Average operation speed	—	—	●
Number of cycles	—	—	●
Piston travel distance (accumulated)	—	—	●
Stop time (Start, End)	—	—	●

\*1 Calibration is required if the product stops operating normally, such as when affected by strong magnetic fields. Calibration must be performed with the product removed from the actuator, away from magnetic fields. Do not perform calibration if the product is operating normally.

CONTENTS	
Specifications .....	p. 5
Weight .....	p. 5
How to Order .....	p. 5
Internal Circuit and Wiring .....	p. 6
Dimensions .....	p. 6
Compact Position Sensor Mounting .....	p. 7
Specific Product Precautions .....	p. 9

# Compact Position Sensor

## D-MPG Series

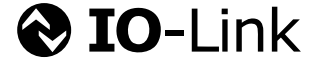

### Specifications

Model	D-MPG□	
Measurement range*1	25 mm ±1 (Default)	
Power supply voltage	13 to 30 VDC, Ripple (p-p) 10% or less (with power supply polarity protection)	
Current consumption	38 mA or less (When no load is applied)	
Repeatability*2	0.1 mm (Ambient temperature: 25°C)	
Resolution	0.01 mm	
Linearity	±0.6 mm (Ambient temperature: 25°C, Measurement range: 25 mm) ±1.5 mm (Ambient temperature: 25°C, Measurement range: 35 mm)	
Switch output	NPN or PNP (Push-pull)	
Max. load current	40 mA	
Internal voltage drop	1 V or less	
Leakage current	0.1 mA or less	
Short-circuit protection	Yes	
Analog current output*3	Output current: 4 to 20 mA (Default)	
Min. load resistance	400 Ω	
Analog voltage output*3	Output voltage: 0 to 10 V, 1 to 5 V	
Min. load resistance	2 kΩ	
Indicator light	MR (Orange), PWR (Green), OUT1 (Orange), CURRENT (Blue), VOLTAGE (Green)	
Lead wire	PUR 4 cores Sensor head: ø2.2, Teach unit: ø2.6 0.08 mm <sup>2</sup>	
Standards	CE/UKCA marking, UL (CSA)	
Impact resistance	300 m/s <sup>2</sup>	
Insulation resistance	50 MΩ or more (500 VDC measured via megohmmeter)	
Withstand voltage	1000 VAC for 1 minute	
Ambient temperature	-10 to 60°C (When using an analog current: -10 to 50°C)	
Enclosure	IP67 (IEC 60529)	
IO-Link	Version	V1.1
	Communication speed	COM3 (230.4 kbps)
	Process data size	Input: 4 bytes, Output: 0 bytes
	Min. cycle time	1 ms
	Device ID	243 hex
Vendor ID	83 hex	

\*1 The measurement range can be changed to up to 35 mm, but the product will be more susceptible to external disturbances.

\*2 This is the repeatability due to the movement of the magnet from one direction.

\*3 It is possible to select between analog voltage (0 to 10 V), analog voltage (1 to 5 V), and analog current (4 to 20 mA).

### Teach Unit Lead Wire Specifications

Model	D-MPG□
Sheath	Outside diameter [mm]: ø2.6
Insulator	Number of cores: 4 (Brown/Blue/Black/White)
	Outside diameter [mm]: ø0.57
Conductor	Effective area [mm <sup>2</sup> ]: 0.08
Min. bending radius [mm] (Reference value)	13

### Weight

Model	Weight [g]
D-MPGA□	28
D-MPGB□	17
D-MPGC□	23

### How to Order

D-MPG **A** **1**

Teach unit lead wire

Sensor head lead wire

Symbol	Specifications
A	Discrete wires, 2.0 m
B	M8 4-pin, 0.3 m
C	M12 4-pin, 0.3 m

1	100 mm
2	300 mm

## Internal Circuit and Wiring

### SIO mode

NPN output

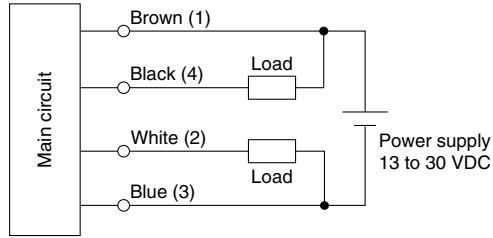

PNP output

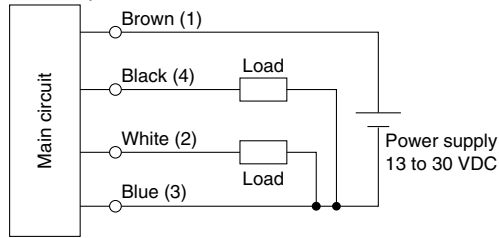

### IO-Link mode

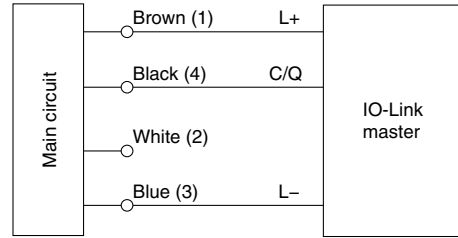

Connector pin numbers are shown in parentheses.

Analog output (white) is disabled when the IO-Link mode is selected.

Wiring		Description
Connector pin number	Wire color	
1	Brown	Power supply DC(+)
2	White	Analog current output/ Analog voltage output/ Switch output*1
3	Blue	Power supply DC(-)
4	Black	Switch output/IO-Link

\*1 When used as a switch output, wire it in the same manner as the black wire. Switch outputs can only be configured for IO-Link.

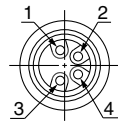

M8 connector pin assignment

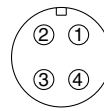

M12 connector pin assignment

## Dimensions

### D-MPGA □

Discrete wires, 2.0 m

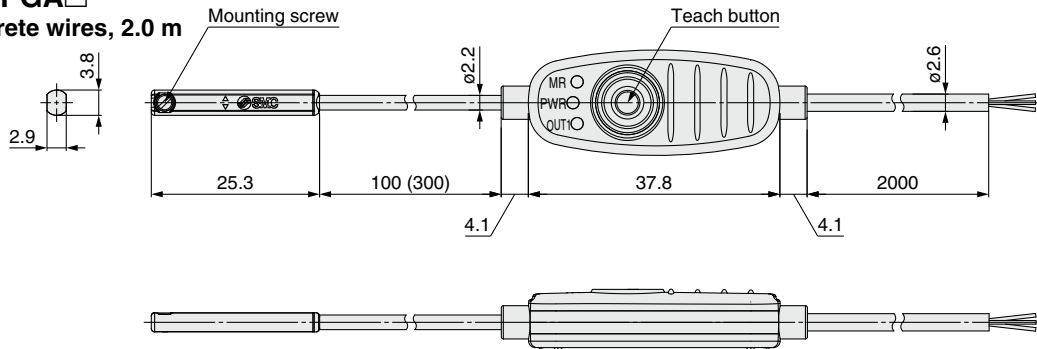

### D-MPGB □

M8 4-pin, 0.3 m

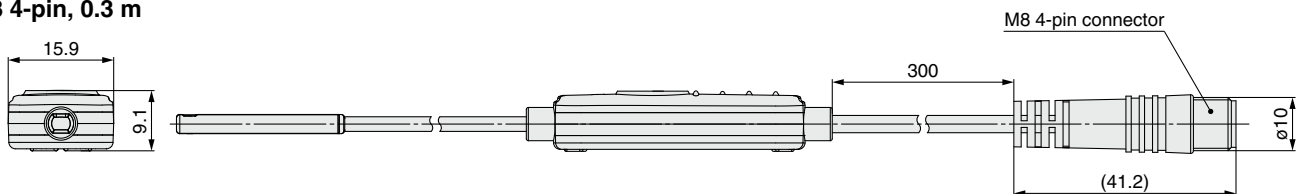

### D-MPGC □

M12 4-pin, 0.3 m

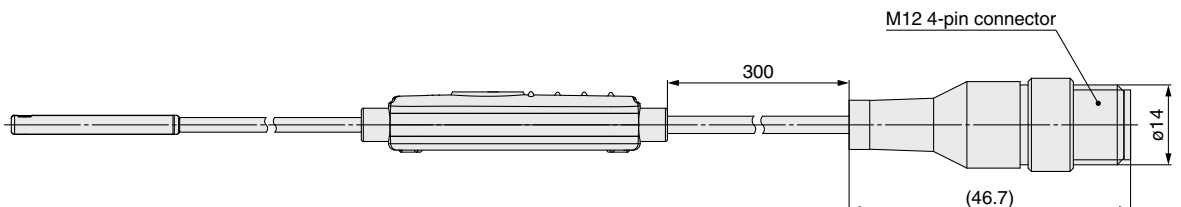











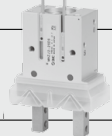
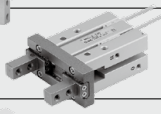

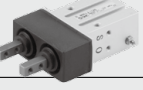

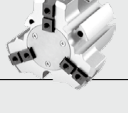
# D-MPG Series

# Compact Position Sensor Mounting

## Applicable Actuators

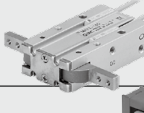
The compact position sensor cannot be ordered with the cylinder model number. It must be ordered separately. Refer to page 5 for the compact position sensor model number.

Applicable actuator	Series	6	10	12	16	20	25	32	40	50	63	80	100
Parallel Air Gripper	MHZ2 	●	●*1		●	●	●	●	●				
Parallel Air Gripper Long Stroke	MHZL2 		●*1		●	●	●						
Parallel Air Gripper With Dust Cover	MHZJ2 				●	●	●						
Compact Parallel Air Gripper	JMHZ2 			●	●	●							
Wedge Cam driven Slide type Air Gripper	MHK2 			●	●	●	●						
Wedge Cam driven Slide type Air Gripper - Long Stroke	MHKL2 			●	●	●	●						
Parallel Air Gripper 2-Finger	MHS2 				●	●	●	●*1	●*1	●*1	●*1		
Parallel Air Gripper 3-Finger	MHS3 				●	●	●	●*1	●*1	●*1	●*1	●*1	●*1
Parallel Air Gripper 3-Finger - Long Stroke	MHSL3 				●	●	●	●*1	●*1	●*1	●*1	●*1	●*1
Parallel Air Gripper 3-Finger with Dust Cover	MHSJ3 				●	●	●	●	●	●	●	●	
Parallel Air Gripper 3-Finger - Through-hole Type	MHSH3 				●	●	●	●	●	●	●	●	
Parallel Air Gripper 4-Finger	MHS4 				●	●	●	●*1	●*1	●*1	●*1		
Angular Air Gripper Standard	MHC2 	●	●*1		●*1	●*1	●*1						
Toggle Air Gripper	MHT2 								●	●	●		
180° Angular Air Gripper Cam Type	MHY2 		●		●	●	●						
180° Angular Air Gripper Rack & Pinion Type	MHW2 					●*1	●*1	●*1	●*1	●*1			

\*1 Order the BMG2-012 compact position sensor mounting bracket separately.

\* Due to the structure of the air gripper, the linearity specifications may not be satisfied.



## Mounting

### Direct mounting type

#### Horizontal

When fixing the compact position sensor, insert it into the auto switch mounting groove of the air gripper from the direction shown in the diagram below, and after setting the mounting position, use a small flat-blade screwdriver to tighten the compact position sensor mounting screw.

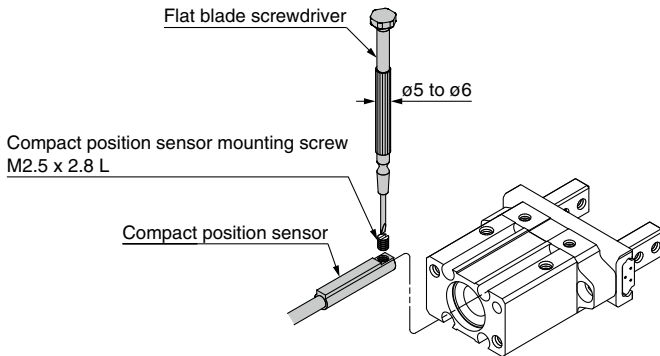

\* When tightening the compact position sensor mounting screw, use a screwdriver with a handle diameter of 5 to 6 mm. The tightening torque should be 0.05 to 0.1 N·m.

#### Vertical

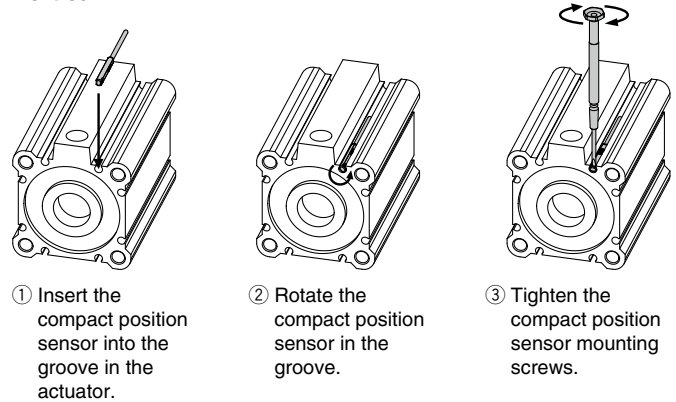

### How to Mount and Move the Compact Position Sensor

1. Insert the compact position sensor mounting bracket into the auto switch mounting groove of the air gripper as shown below and set it in the required mounting position for the position sensor.
2. Insert the compact position sensor into the compact position sensor mounting bracket installation groove.
3. After checking the detection position, secure the compact position sensor by tightening the set screw (M2.5) attached to the compact position sensor.
4. When changing the detection position, follow the steps described in 2.

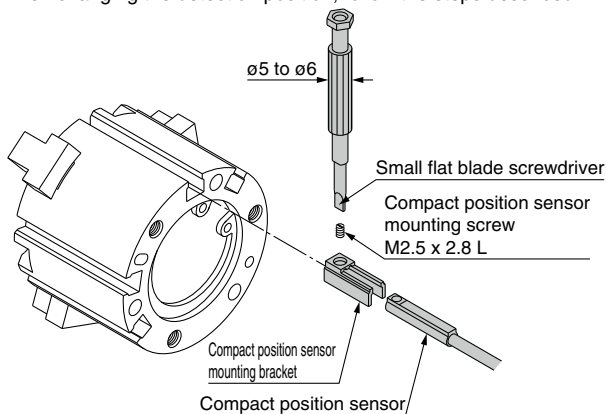

#### Compact Position Sensor Mounting Bracket/Part No.

Compact position sensor part no.	Compact position sensor mounting bracket part no.
D-MPG□	BMG2-012

\* When tightening the compact position sensor mounting screw, use a screwdriver with a handle diameter of 5 to 6 mm. The tightening torque should be 0.05 to 0.1 N·m.

## Position Sensor Mounting Position

### Position Sensor Correct Mounting Position (B dimension)

Model	6	10	12	16	20	25	32	40	50	63	80	100
MHZ2	■	2		2	4.5	7	10	14				
MHZL2		2		2	4	5						
MHZJ2	■	■		1	3	6						
JMHZ2			■	1	4							
MHK2			2	1	5	6						
MHKL2			3.5	4	7.5	8.5						
MHS2				2	2	2	3	4	8	9.5		
MHS3				2	2	2	3	4	8	9.5	15	22
MHSL3				1	2	4	6	8	11.5	14.5		
MHSJ3				0.5	0.5	1	2	3	6.5	9	10.5	
MHSH3				0.5	0.5	1	2	3	6.5	9	10.5	
MHS4				2	2	2	3	4	8	9.5		
MHC2	■	1		2	2	2						
MHT2								10	16	18.5		
MHY2		6		7	12	17.5						
MHW2					2.5	4	10	14.5				

- \* Adjust the position sensor after checking the operating conditions in the actual installation.
- \* Only models capable of full stroke detection are listed.
- \* For ■, insert the sensor all the way into the actuator groove. The sensor housing may protrude from the end surface of the actuator.

### Recommended mounting position

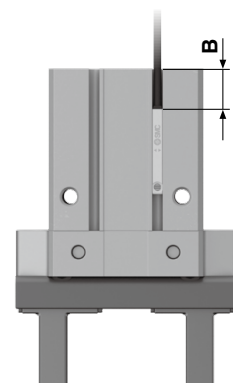



## D-MPG Series

# Compact Position Sensor / Specific Product Precautions

Be sure to read this before handling the products. Refer to the back cover for safety instructions. For actuator and auto switch precautions, refer to the “Handling Precautions for SMC Products” and the “Operation Manual” on the SMC website: <https://www.smcworld.com>

### Design / Selection

#### Caution

##### 1. Detectable position limitations

When the position is to be measured over the full stroke of the cylinder, use a cylinder with a stroke 5 mm shorter than the sensor range.

Use a D-MP position sensor or stroke reading cylinder when the full stroke cannot be detected by the compact position sensor.

##### 2. Output operation of the compact position sensor is not stable for 150 ms after power is turned ON.

In the output operation immediately after power is turned ON, the input device (PLC, relay, etc.) may determine that the ON position is an OFF output or the OFF position is an ON output. Please set the equipment so that input determination after power is turned ON is disabled for 150 ms.

##### 3. Install rotation prevention to the actuator piston rod.

Use a guide or select an SMC product with a rotation prevention function.

The accuracy may decrease without rotation prevention.

With some cylinders, the magnet may rotate even if the piston rod does not rotate. The magnet inside some cylinders with a guide may rotate. Please contact SMC for details.

##### 4. If power is turned ON while the magnet is outside of the measurement range, the analog output will indicate the lower limit value. The switch output will indicate a low logic level.

**(The analog current is 4 mA, analog voltage is 0 V, switch output is ON for NPN output and OFF for PNP output).**

The Analog output and switch output will operate normally after operating the cylinder through its full stroke at least once.

##### 5. Accuracy may decrease under the following operating conditions.

Accuracy may decrease if the sensor is not warmed up for 10 to 15 mins, when there is play (due to mechanical factors, floating joints, etc.), there is external disturbance, magnetic materials (iron, screws), due to the mounting position (geometric field), due to the ambient temperature, or in an environment affected by magnetic forces. It is recommended that non-magnetic materials are used for surrounding parts such as screws (Especially when the sensor and mounting screws are in close proximity, such as with the CDQ2).

### Operating Environment

#### Caution

##### 1. Do not use in welding environments or in areas where magnetic fields are generated.

This may cause the compact position sensor to malfunction or lose accuracy.

If used in a strong magnetic field environment (18 mT), the sensor will not function normally and calibration will be required.

### Maintenance

#### Warning

##### 1. The compact position sensor may malfunction unexpectedly, making it impossible to confirm safety. Therefore, perform regular maintenance or inspections.

### Mounting / Adjustment

##### 1. Check the actual operating conditions and adjust the mounting position of the compact position sensor accordingly.

Depending on the installation environment, the cylinder/actuator may not operate even when installed in the correct position. Even when set at the middle of the stroke, check the operating conditions and make adjustments accordingly.

If it does not operate correctly, it may be improved by restarting the power supply or by operating the piston for several strokes.

##### 2. When the power is turned ON again, the magnetic parameters may not be stored (EEPROM) completely, and the repeatability may not satisfy the specifications.

In this case, repeat 10 to 20 strokes and reset/adjust the product, then power ON for at least 15 minutes.

### Wiring

##### 1. Do not disconnect the cable between the sensor and teach unit of the compact position sensor.

Even when the sensor head and teach unit are reconnected, a contact resistance is produced, causing the compact position sensor to malfunction. Additionally, the sensor head and teach unit are paired and will not operate correctly in different combinations.

## Safety Instructions

These safety instructions are intended to prevent hazardous situations and/or equipment damage. These instructions indicate the level of potential hazard with the labels of “**Caution**,” “**Warning**” or “**Danger**.” They are all important notes for safety and must be followed in addition to International Standards (ISO/IEC)\*1), and other safety regulations.

 **Danger :** **Danger** indicates a hazard with a high level of risk which, if not avoided, will result in death or serious injury.

 **Warning:** **Warning** indicates a hazard with a medium level of risk which, if not avoided, could result in death or serious injury.

 **Caution:** **Caution** indicates a hazard with a low level of risk which, if not avoided, could result in minor or moderate injury.

\*1) ISO 4414: Pneumatic fluid power - General rules and safety requirements for systems and their components  
ISO 4413: Hydraulic fluid power - General rules and safety requirements for systems and their components  
IEC 60204-1: Safety of machinery - Electrical equipment of machines - Part 1: General requirements  
ISO 10218-1: Robots and robotic devices - Safety requirements for industrial robots - Part 1: Robots etc.

### Warning

#### 1. The compatibility of the product is the responsibility of the person who designs the equipment or decides its specifications.

Since the product specified here is used under various operating conditions, its compatibility with specific equipment must be decided by the person who designs the equipment or decides its specifications based on necessary analysis and test results. The expected performance and safety assurance of the equipment will be the responsibility of the person who has determined its compatibility with the product. This person should also continuously review all specifications of the product referring to its latest catalog information, with a view to giving due consideration to any possibility of equipment failure when configuring the equipment.

#### 2. Only personnel with appropriate training should operate machinery and equipment.

The product specified here may become unsafe if handled incorrectly. The assembly, operation and maintenance of machines or equipment including our products must be performed by an operator who is appropriately trained and experienced.

#### 3. Do not service or attempt to remove product and machinery/equipment until safety is confirmed.

1. The inspection and maintenance of machinery/equipment should only be performed after measures to prevent falling or runaway of the driven objects have been confirmed.
2. When the product is to be removed, confirm that the safety measures as mentioned above are implemented and the power from any appropriate source is cut, and read and understand the specific product precautions of all relevant products carefully.
3. Before machinery/equipment is restarted, take measures to prevent unexpected operation and malfunction.

#### 4. SMC products cannot be used beyond their specifications. They are not developed, designed, and manufactured to be used under the following conditions or environments. Use under such conditions or environments is not allowed.

1. Conditions and environments outside of the given specifications, or use outdoors or in a place exposed to direct sunlight.
2. Use for nuclear power, railways, aviation, space equipment, ships, vehicles, military application, equipment affecting human life, body, and property, combustion equipment, entertainment equipment, emergency shut-off circuits, press clutches, brake circuits, safety equipment, etc., and use for applications that do not conform to standard specifications such as catalogs and operation manuals.
3. Use for interlock circuits, except for use with double interlock such as installing a mechanical protection function in case of failure. Please periodically inspect the product to confirm that the product is operating properly.

### Caution

**SMC develops, designs, and manufactures products to be used for automatic control equipment, and provides them for peaceful use in manufacturing industries.**

**Use in non-manufacturing industries is not allowed.**

Products SMC manufactures and sells cannot be used for the purpose of transactions or certification specified in the Measurement Act of each country. The new Measurement Act prohibits use of any unit other than SI units in Japan.

### Limited warranty and Disclaimer/ Compliance Requirements

The product used is subject to the following “Limited warranty and Disclaimer” and “Compliance Requirements”.

Read and accept them before using the product.

#### Limited warranty and Disclaimer

1. The warranty period of the product is 1 year in service or 1.5 years after the product is delivered, whichever is first.\*2)  
Also, the product may have specified durability, running distance or replacement parts. Please consult your nearest sales branch.
2. For any failure or damage reported within the warranty period which is clearly our responsibility, a replacement product or necessary parts will be provided.  
This limited warranty applies only to our product independently, and not to any other damage incurred due to the failure of the product.
3. Prior to using SMC products, please read and understand the warranty terms and disclaimers noted in the specified catalog for the particular products.

\*2) **Suction cups (Vacuum pads) are excluded from this 1 year warranty.**

A suction cup (vacuum pad) is a consumable part, so it is warranted for a year after it is delivered.

Also, even within the warranty period, the wear of a product due to the use of the suction cup (vacuum pad) or failure due to the deterioration of rubber material are not allowed by the limited warranty.

#### Compliance Requirements

1. The use of SMC products with production equipment for the manufacture of weapons of mass destruction (WMD) or any other weapon is strictly prohibited.
2. The exports of SMC products or technology from one country to another are governed by the relevant security laws and regulations of the countries involved in the transaction. Prior to the shipment of a SMC product to another country, assure that all local rules governing that export are known and followed.

## Safety Instructions

Be sure to read the “Handling Precautions for SMC Products” (M-E03-3) and “Operation Manual” before use.