

Heatless Air Dryer

ID Series

Heatless ID series is best when dry air with a low dew point is needed.

Supply dry air with a low dew point below -30°C .

Compact and lightweight without heater and electric control board.

Possible to check the outlet dew point with the indicator.

(Self-regenerative type allows for easy maintenance.)



Model

| Specifications | | Model | ID20□ | ID30□ | ID40□ | ID60□ |
|----------------------------|--|---|-------|------------|-------|----------|
| Operating range (Note 1) | Fluid | Compressed air | | | | |
| | Inlet air temperature $^{\circ}\text{C}$ | 5 to 50 (No water droplets) | | | | |
| | Inlet air pressure MPa | 0.3 to 1.0 | | 0.3 to 0.9 | | |
| | Ambient temperature $^{\circ}\text{C}$ | 2 to 50 | | | | |
| | Outlet air flow rate L/min (ANR) (Note 2) | 80 | 155 | 330 | 780 | |
| Rating (Note 4) | Recycled air flow rate L/min (ANR) (Note 3) | 20 | 37 | 85 | 195 | |
| | Inlet air flow rate L/min (ANR) | 100 | 192 | 415 | 975 | |
| | Inlet air pressure MPa | 0.7 | | | | |
| | Inlet air temperature $^{\circ}\text{C}$ | Standard 35 Option Z 20 | | | | |
| | Outlet air atmospheric pressure dew point $^{\circ}\text{C}$ | Standard -30 Option Z -50 (Note 5) | | | | |
| Electrical characteristics | Power supply voltage | Refer to How to Order. | | | | |
| | Power consumption W | 30 | | | | |
| Installation features | | Indoor | | | | |
| Port size | | 1/4 | | 1/2 | | 3/4 |
| Weight kg | | 7 | | 8.5 | | 18.5, 25 |

Note 1) The operating range does not guarantee use at the rated outlet air flow rate.

Note 2) Refers to the air flow rate under standard conditions (ANR) [20°C , atmospheric pressure, and 65% relative humidity]

Note 3) The recycled air flow rate includes the indicator purge air flow rate of 2 L/min (ANR) (when the inlet air pressure is 0.7 MPa).

Note 4) If the operating conditions differ from the rated values, select according to the flow rate characteristics and the dew point chart.

Note 5) For Option "Z," install a refrigerated air dryer on the inlet side.

Replacement Parts

| Model | | ID20□ | ID30□ | ID40□ | ID60□ |
|------------------------|----------|----------|---------|----------|---------|
| Adsorbent set (Note 6) | Standard | ID-200S | ID-300S | ID-400S | ID-600S |
| | Option Z | ID-200Z | ID-300Z | ID-400Z | ID-600Z |
| Bracket (Note 7) | | ID-S0058 | | ID-S0059 | |
| Indicator set | | ID-DPM8 | | | |

Note 6) A set of adsorbent and a filter element for 1 air dryer (2 adsorption tubes) as well as O-rings

Note 7) For 1 air dryer (Set of 2)

How to Order

ID 20 0 - 02 □

Size

| |
|----|
| 20 |
| 30 |
| 40 |
| 60 |

Symbol



Power supply voltage

| Symbol | Description |
|--------|--|
| 0 | Single phase 100 VAC (50 Hz) 100, 110 VAC (60 Hz) |
| 1 | Single phase 110 VAC (50 Hz) |
| 5 | Single phase 200 VAC (50 Hz) 200, 220 VAC (60 Hz) |
| 6 | Single phase 220 VAC (50 Hz) |

Thread type

| Symbol | Type |
|--------|------|
| Nll | Rc |
| F | G |
| N | NPT |

Option

| Symbol | Description |
|--------|--|
| Nll | — |
| B | Bracket |
| Z | Atmospheric pressure dew point -50°C |

Port size

| Symbol | Size | Applicable size | | | |
|--------|------|-----------------|----|----|----|
| | | 20 | 30 | 40 | 60 |
| 02 | 1/4 | ● | — | — | — |
| 04 | 1/2 | — | ● | ● | — |
| 06 | 3/4 | — | — | — | ● |

Working Principle

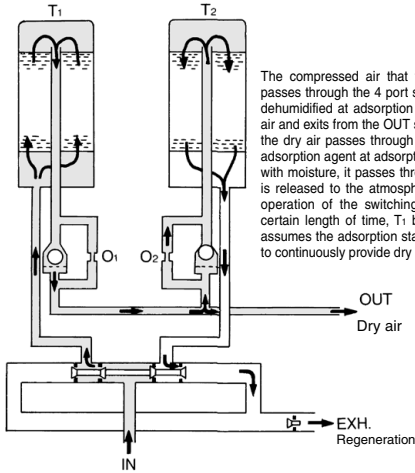

Flow rate characteristics

Inlet air pressure: 0.7 MPa

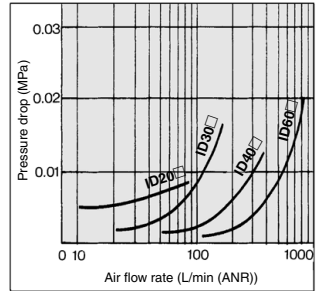

Recycled Flow Rate

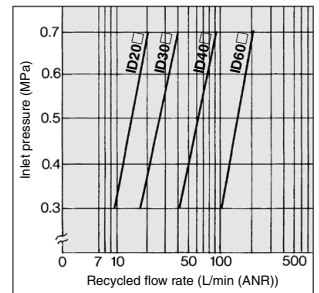

Operating System Diagram/Time Chart/Electric Circuit Diagram

Operating system diagram

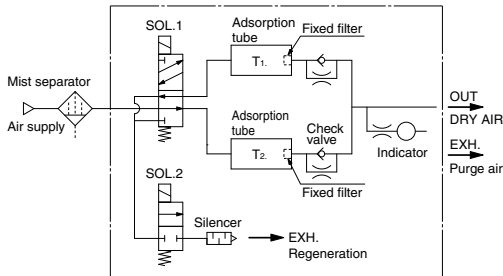

Dew Point

Condition: Air flow/Rating

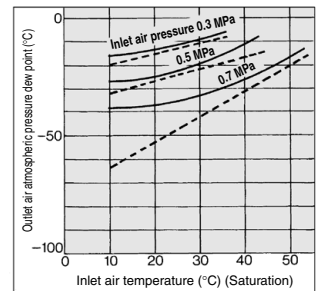

Time chart

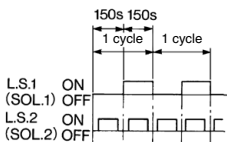

Electric circuit

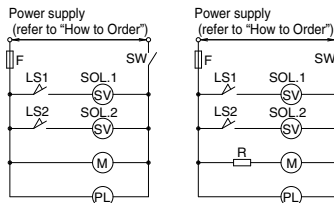

For ID00, ID01

For ID05, ID06

| Symbol | Description |
|--------|-----------------------|
| SOL.1 | 4 port solenoid valve |
| SOL.2 | 4 port solenoid valve |
| F | Fuse |
| SW | Snap switch |

| Symbol | Description |
|--------|--------------|
| PL | Light |
| LS1,2 | Micro switch |
| M | Timing motor |
| R | Resistor |

- HAA
- HAW
- AT
- IDF
- IDU
- IDF
- IFS
- IDFA
- IDFB
- IDH
- ID
- IDG
- IDK
- AMG
- AFF
- AM
- AMD
- AMH
- AME
- AMF
- ZFC
- SF
- SFD
- LLB
- AD
- GD

Dimensions

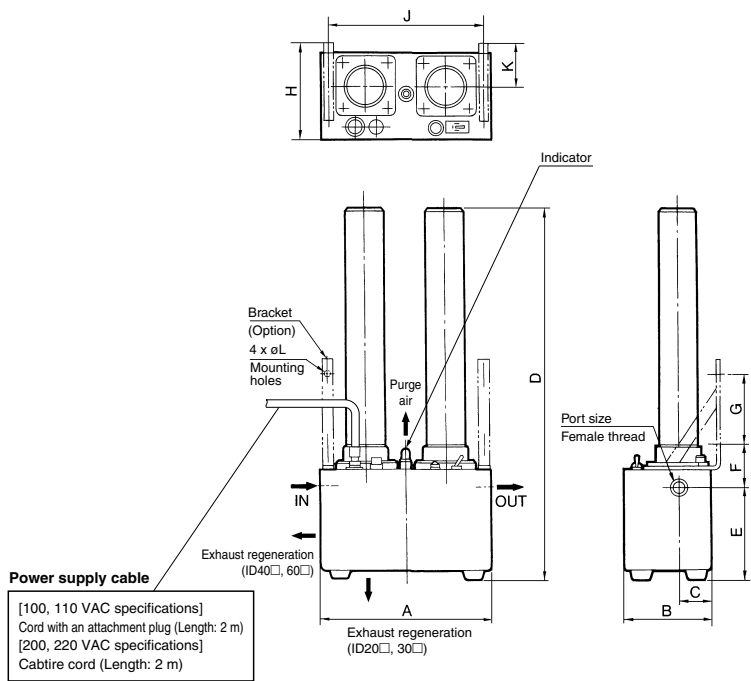

| Model | Port size Nominal size (B) | A | B | C | D | E | Mounting dimension | | | | | |
|-------|-------------------------------|-----|-----|----|-----|-------|--------------------|----|-------|-----|------|----------|
| | | | | | | | F | G | H | J | K | ϕL |
| ID20□ | 1/4 | 240 | 120 | 45 | 520 | 128.5 | 59.5 | 95 | 134.5 | 222 | 59.5 | 9 |
| ID30□ | 1/2 | 240 | 120 | 45 | 615 | 128.5 | 59.5 | 95 | 134.5 | 222 | 59.5 | 9 |
| ID40□ | 1/2 | 320 | 170 | 75 | 850 | 243.5 | 66.5 | 95 | 183 | 302 | 88 | 9 |
| ID60□ | 3/4 | 320 | 170 | 75 | 961 | 243.5 | 66.5 | 95 | 183 | 302 | 88 | 9 |

(mm)



ID Series

Specific Product Precautions

Be sure to read this before handling the products. Refer to back page 50 for Safety Instructions and pages 6 to 8 for Air Preparation Equipment Precautions.

Caution on Design

⚠ Caution

1. Install this air dryer on a pneumatic line that provides a supply capacity that exceeds the required outlet air flow rate and reactivated air flow rate.
If the pneumatic line cannot provide the supply capacity indicated, the required outlet air flow rate and pressure cannot be obtained.
2. Make sure to install a mist separator on the inlet side.
If foreign matter such as oil mist or dust is present in the compressed air, the capillary tissue of the adsorption agent becomes blocked. This will substantially reduce the adsorption capacity and at the same time, shorten the life of the adsorption agent.
3. Due to a pressure fluctuation that occurs during the switching of the adsorption cylinders, the small particles of the adsorption agent could splash to the outlet side.
Install a mist separator or a micro mist separator on the outlet side according to the application.
4. When installing a regulator, install it on the outlet side of the heatless air dryer.
If it is installed on the inlet side and used when the pneumatic pressure is low, the air dryer's dehumidifying capacity cannot be put into full play. (For details, refer to the performance line graph in this section.)
5. For Option "Z" (Atmospheric pressure dew point: -50°C), install a refrigerated air dryer on the inlet side. Although Option "Z" can be used without installing a refrigerated air dryer, it will only be able to obtain an atmospheric pressure dew point of approx. -30°C, the same as that of the standard model.

Piping

⚠ Caution

1. Make sure to provide a bypass pipe in case the flow of air cannot be stopped during maintenance, such as when replacing the adsorption agent.
2. Install the dryer horizontally.
3. Do not allow the weight of piping to lie directly on air dryer.
4. Do not connect a tube smaller than the port size to the inlet side. In particular, when using a resin tube, make sure that the size would not be smaller than the port size.
(Example: If ID60□ is connected to a ø12 tube, air supply may not be sufficient and it may cause malfunction due to the unstable operation of the check valve.)
5. Be sure to use piping and fittings made from fluoropolymer or a metal such as stainless steel for the heatless air dryer outlet side piping.
Use of piping and fittings made from any other materials may result in a rise in the dew point at the end of the piping due to moisture absorption.

Operating Environment

⚠ Caution

The air that has been used for reactivating the adsorption agent and the air that has passed through the indicator are discharged externally from the heatless air dryer. Therefore, use the dryer in an area where the discharge will not be a problem.

Operation

⚠ Caution

Turn ON the power after the air dryer has been pressurized. If the power is turned ON before it is pressurized (particularly when the pressure is low), the check valve will not operate properly, possibly creating an abnormally large reactivated air flow rate.

Maintenance

⚠ Caution

1. It is possible to check the outlet air atmospheric pressure dew point by checking the color of the indicator. If the outlet air atmospheric pressure dew point cannot be obtained within the operating range, replace the adsorbent.
Also keep in mind that the recommended replacement period of the adsorbent is after approx. 1 year of use.

| Outlet air atmospheric pressure dew point | Color of indicator (Guide) |
|---|----------------------------|
| -30°C or less | Orange |
| -18°C | Slightly cloudy orange |
| 5°C | Dark green |

Conditions/Inlet air pressure 0.7 MPa, Inlet air temperature 30°C
Please use the adsorbent set (refer to page 134 for "Replacement Parts") when replacing the adsorbent.

In addition, if the indicator turns black or brown, it may mean that oil or some other gas component other than air has adhered to the indicator. In such a case, it is recommended that the indicator and adsorbent be replaced. (Refer to page 134 for replacement parts.)

2. Replace the element of the mist separator, installed on the inlet side, on a regular basis. (Refer to the instruction manual of the mist separator for details such as the replacement interval and procedures.)
3. The indicator color and dew point temperature (atmospheric pressure) are to be used as a guide. If an accurate value is required, use a dew point meter.
4. If oil mist adheres to the indicator silica gel, it may turn black or brown. If the color has changed, the indicator can no longer be used and must be replaced. In addition, the adsorbent and the element of the mist separator installed on the inlet side must also be replaced.

HAA
HAW
AT
IDF
IDU
IDF
IFS
IDFA
IDFB
IDH
ID
IDG
IDK
AMG
AFF
AM
AMD
AMH
AME
AMF
ZFC
SF
SFD
LLB
AD□
GD