

S Couplers

KK130 Series

Energy saving by pressure loss reduction

C factor increased by **34%** (Thread R1/4 type Compared to the current model*)

Plug insertion force reduced by **22% (20 N)** (Compared to the current model* at 0.5 MPa)

Lightweight reduced by **14% (12 g)** (Compared to the current model*)

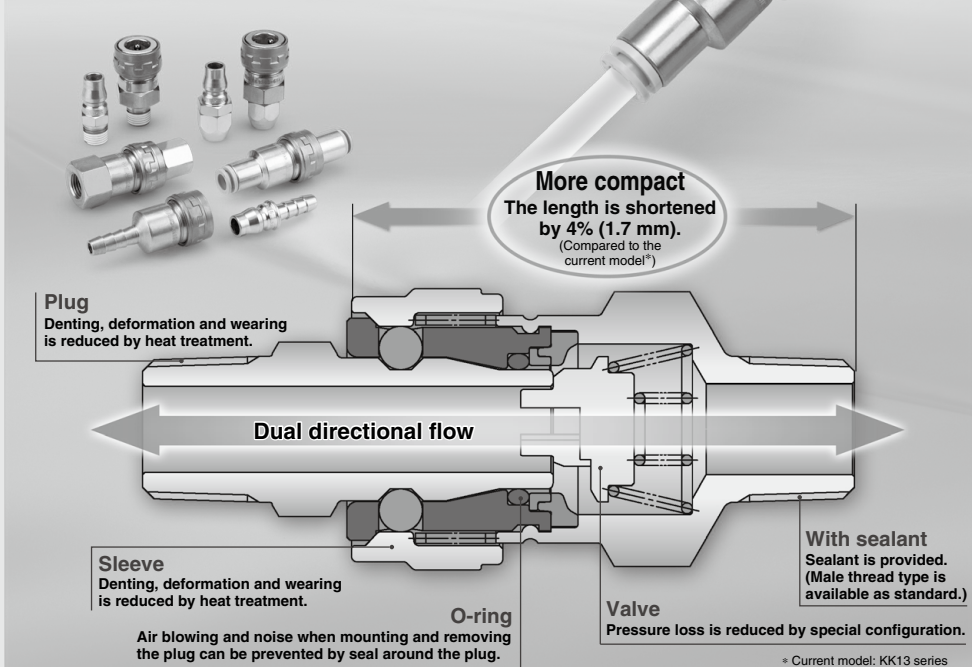

One-touch fitting provided type is standardized.



Metric size: $\phi 6$, $\phi 8$, $\phi 10$, $\phi 12$
Inch size: $\phi 1/4$ ", $\phi 5/16$ ", $\phi 3/8$ ", $\phi 1/2$ "

With lock mechanism (Semi-standard)

Removal by unexpected impact can be prevented. Locked and released position can be maintained by the detent on the sleeve.

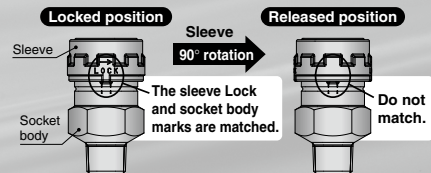

KQ2
KQB2
KS
KX
KM
KF
M
H/DL
L/LL
KC
KK
KK130
DM
KDM
KB
KR
KA
KQG2
KG
KFG2
MS
KKA
KP
LQ
MQR
T
IDK

Energy saving and cost reduction

Since pressure loss is smaller than the current product (KK13 series), even if inlet pressure is reduced, equivalent outlet pressure and flow rate can be achieved when it is used for air blow. It is possible to reduce the cost with lower air and energy consumption of compressors.

Inlet pressure and compressor electric power cost against operating flow rate (per coupler)

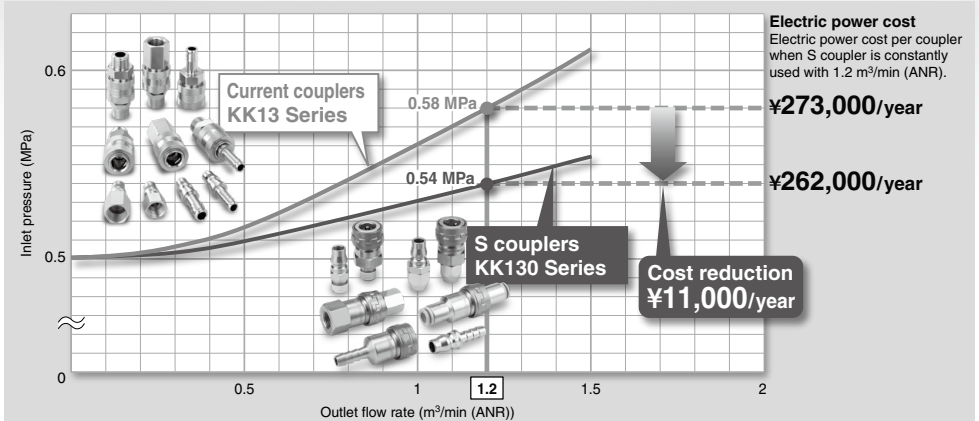

[Calculation conditions]

Operating pressure at the outlet: 0.5 MPa
Compressor efficiency: 0.7
Electric power cost: 15 yen/kWh
Annual operating time: 2500 hours

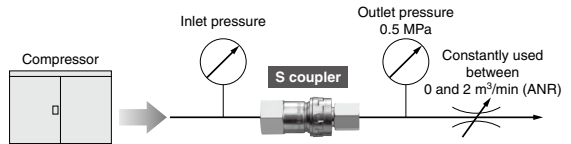

Cost reduction effect by using S couplers in a factory

It is possible to achieve a large cost reduction when looking at the effect on a factory scale.

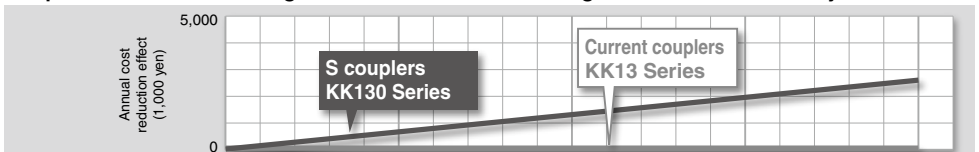

Quantity of S couplers used in a factory	(pcs.)	500	1,000	1,500	2,000
Air consumption of whole factory	(m ³ /hr (ANR))	3,600	7,200	10,800	14,400
Compressor capacity of whole factory	(kWh)	650	1,300	1,950	2,600

Note) The relationship between the total compressor capacity, air consumption and quantity of S couplers is shown as a general guideline.

[Calculation conditions]

50% of the total air consumed in the factory passes through the S coupler, and 4 S couplers are used at the end of the line.
Operating pressure at the outlet: 0.5 MPa
Air consumption of one line at end: 1.2 m³/min (ANR)
Air consumption time: 20% of annual operating time of 2500 hours
Compressor efficiency: 0.7
Electric power cost: 15 yen/kWh
Compressor capacity: 8 m³/kWh

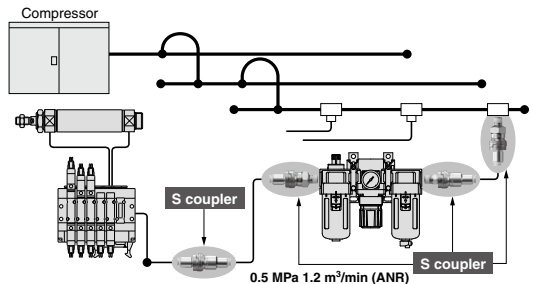

KK130 Series Variations



Plug (P)

Male thread type

	Port size	Model
	R1/8	KK130P-01MS
R1/4	-02MS	
R3/8	-03MS	
R1/2	-04MS	
NPT1/8	-N01MS	
NPT1/4	-N02MS	
NPT3/8	-N03MS	
NPT1/2	-N04MS	

Female thread type

	Port size	Model
	Rc1/8	KK130P-01F
Rc1/4	-02F	
Rc3/8	-03F	
Rc1/2	-04F	
NPT1/8	-N01F	
NPT1/4	-N02F	
NPT3/8	-N03F	
NPT1/2	-N04F	

Barb fitting type (for rubber hose)

	Hose nominal	Model
	6 (1/4")	KK130P-07B
8 (1/4")	-09B	
9 (3/8")	-11B	
12 (1/2")	-13B	

* The figures in () indicate the internal diameter of the applicable hose.

Nut fitting type (for fiber reinforced urethane hose)

	Applicable hose I.D./O.D.	Model
	5/8	KK130P-50N
6/9	-60N	
6.5/10	-65N	
8/12	-80N	
8.5/12.5	-85N	
11/16	-110N	

One-touch fitting type

	Applicable tube O.D.	Model
	Metric size mm	6
8		-08H
10		-10H
12		-12H
Inch size	1/4"	-07H
	5/16"	-09H
	3/8"	-11H
	1/2"	-13H

Refer to pages 227 and 228 for specific product precautions.



Socket (S)

Male thread type

	Port size	Model*
	R1/8	KK130S-01MS
R1/4	-02MS	
R3/8	-03MS	
R1/2	-04MS	
NPT1/8	-N01MS	
NPT1/4	-N02MS	
NPT3/8	-N03MS	
NPT1/2	-N04MS	

* Refer to the how to order on page 234 for the sleeve lock mechanism provided type.

Female thread type

	Port size	Model*
	Rc1/8	KK130S-01F
Rc1/4	-02F	
Rc3/8	-03F	
Rc1/2	-04F	
NPT1/8	-N01F	
NPT1/4	-N02F	
NPT3/8	-N03F	
NPT1/2	-N04F	

* Refer to the how to order on page 234 for the sleeve lock mechanism provided type.

Barb fitting type (for rubber hose)

	Hose nominal	Model*
	6 (1/4")	KK130S-07B
8 (1/4")	-09B	
9 (3/8")	-11B	
12 (1/2")	-13B	

* Refer to the how to order on page 234 for the sleeve lock mechanism provided type.

* The figures in () indicate the internal diameter of the applicable hose.

Nut fitting type (for fiber reinforced urethane hose)

	Applicable hose I.D./O.D.	Model*
	5/8	KK130S-50N
6/9	-60N	
6.5/10	-65N	
8/12	-80N	
8.5/12.5	-85N	
11/16	-110N	

* Refer to the how to order on page 234 for the sleeve lock mechanism provided type.

One-touch fitting type

	Applicable tube O.D.	Model*
	Metric size mm	6
8		-08H
10		-10H
12		-12H
Inch size	1/4"	-07H
	5/16"	-09H
	3/8"	-11H
	1/2"	-13H

* Refer to the how to order on page 234 for the sleeve lock mechanism provided type.

QK2

QKB2

KS
KX

KM

KF

M

H/DL
L/LL

KC

KK

KK130

DM

KDM

KB

KR

KA

QKG2

KG

KFG2

MS

KKA

KP

LQ

MQR

T

IDK

S Couplers

KK130 Series



Symbol

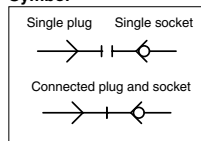

Specifications

Fluid	Air ^{Note)}
Operating pressure range	0 to 1.5 MPa
	One-touch fitting type: 0 to 1.0 MPa
Proof pressure	2.0 MPa
Ambient and fluid temperature	-20 to 80°C (No freezing)
	One-touch fitting type: -5 to 60°C (No freezing)
Plating	Sleeve: Electroless nickel plated Other external metal parts: Zinc chromated
Sealant	Male thread with sealant

Note) Cannot be used for water.

Performance

Plug and socket connection	Sleeve slide detachable type
Check valve	Socket: Built-in check valve
Flow direction	Dual directional
Sleeve lock mechanism	Manual locking type (with detent) Semi-standard

How to Order

KK130 P-02 MS

130 series

Socket/Plug

Symbol	Type
P	Plug
S	Socket
L	Semi-standard Socket (With sleeve lock mechanism)

Connection type

Symbol	Type
MS	Male thread (With sealant)
F	Female thread
B	With barb fitting
N	With nut fitting
H	With One-touch fitting

Port size variations

Male/Female thread type

Symbol	Thread size
01	R, Rc1/8
02	R, Rc1/4
03	R, Rc3/8
04	R, Rc1/2
N01	NPT1/8
N02	NPT1/4
N03	NPT3/8
N04	NPT1/2

Barb fitting type

Symbol	Hose nominal
07	6 (1/4")
09	8 (1/4")
11	9 (3/8")
13	12 (1/2")

* The figures in () indicate the internal diameter of the applicable hose.

Nut fitting type

Symbol	Applicable hose I.D./O.D. mm
50	5/8
60	6/9
65	6.5/10
80	8/12
85	8.5/12.5
110	11/16

One-touch fitting type

Symbol	Applicable tube O.D. mm	
06	ø6	Metric size
08	ø8	
10	ø10	
12	ø12	
07	ø1/4"	Inch size
09	ø5/16"	
11	ø3/8"	
13	ø1/2"	

For details on port size variation and connection type combinations for each model, refer to the charts on the Dimensions page.

Flow Rate Characteristics [Representative Value]

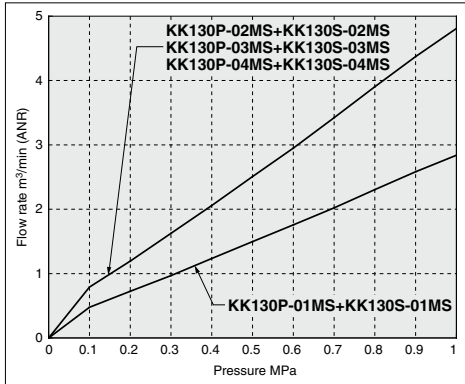

* This flow rate characteristic test method complies with JIS B 8390 (Pneumatic fluid power – Components using compressible fluids – Determination of flow rate characteristics)
 * The figures are representative values when the same type of plug and socket are connected.

Connection type			Sonic conductance C [dm ³ /(s·bar)]	Critical pressure ratio b	Flow coefficient Cv	Effective area S [mm ²]
Type	Symbol	Connection				
Male thread	-01MS	R1/8	4.2	0.4	1.2	21
	-02MS	R1/4	7.0	0.4	1.9	35
	-03MS	R3/8	7.0	0.5	2.1	35
	-04MS	R1/2	7.0	0.5	2.1	35
Female thread	-01F	Rc1/8	6.0	0.5	1.8	30
	-02F	Rc1/4	7.0	0.5	2.1	35
	-03F	Rc3/8	7.0	0.5	2.1	35
	-04F	Rc1/2	7.0	0.5	2.1	35
With barb fitting	-07B	6 (1/4")	2.0	0.4	0.5	10
	-09B	8 (1/4")	3.0	0.4	0.8	15
	-11B	10 (3/8")	6.0	0.5	1.8	30
	-13B	12 (1/2")	7.0	0.5	2.1	35
With nut fitting	-50N	5/8	2.0	0.4	0.5	10
	-60N	6/9	3.5	0.4	1.0	18
	-65N	6.5/10	4.2	0.4	1.2	21
	-80N	8/12	7.0	0.4	1.9	35
With One-touch fitting	-85N	8.5/12.5	7.0	0.4	1.9	35
	-110N	11/16	7.0	0.5	2.1	35
	-06H	ø6	2.0	0.4	0.5	10
	-08H	ø8	4.4	0.5	1.3	22
	-10H	ø10	7.0	0.5	1.8	35
	-12H	ø12	7.0	0.5	2.1	35

Construction

<With One-touch fitting>

<With One-touch fitting>

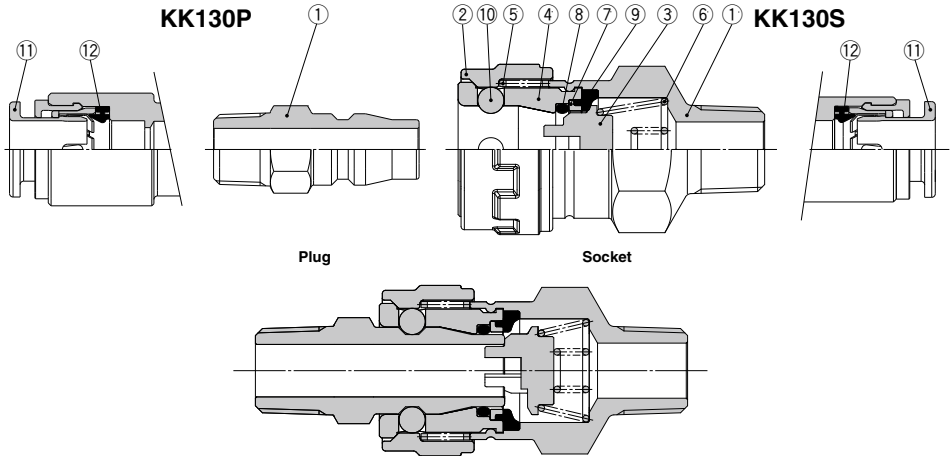

Figure: Connected plug and socket

Plug

No.	Description	Material	Note
1	Plug	Structural steel	Zinc chromated
11	Cassette	—	
12	Seal	NBR	

Socket

No.	Description	Material	Note
1	Socket body	Structural steel	Zinc chromated
2	Sleeve	Steel wire	Electroless nickel plated
3	Valve	Steel wire	Zinc chromated
4	Main body	Steel wire	Zinc chromated
5	Sleeve spring	Stainless steel	
6	Valve spring	Stainless steel	
7	Holder	Steel band	Zinc chromated
8	Plug O-ring	NBR	
9	Seal	NBR	
10	Steel ball	SUJ	
11	Cassette	—	
12	Seal	NBR	

KK130 Series

Dimensions

Plug (KK130P)

Socket (KK130S, L)

Male thread type

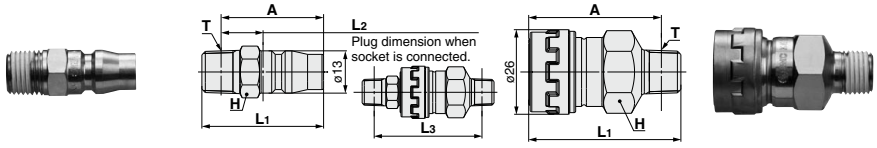

Model	T Connection male thread	H Width across flats	L1	L2	A ⁻¹	Min. hole size	Weight g	When connected Full length L3
KK130P-01MS	R1/8	14	34.0	11.1	30.0	6.0	18	51.1
-02MS	R1/4	14	38.0	13.1	32.0	8.0	22	53.9
-03MS	R3/8	19	39.0	13.6	32.5	8.0	37	53.3
-04MS	R1/2	22	43.0	16.1	35.0	8.0	52	55.9
KK130P-N01MS	NPT1/8	14	34.0	10.1	29.0	6.0	18	49.4
-N02MS	NPT1/4	14	38.0	11.6	30.5	8.0	22	51.5
-N03MS	NPT3/8	19	39.0	12.6	31.5	8.0	37	51.7
-N04MS	NPT1/2	22	43.0	14.1	33.0	8.0	52	52.3

*1 Reference dimension after installation

Model	T Connection male thread	H Width across flats	L1	A ⁻¹	Min. hole size	Weight g
KK130S(L)-01MS	R1/8	22	44.0	40.0	6.0	73
-02MS	R1/4	22	46.8	40.8	8.5	74
-03MS	R3/8	22	46.2	39.7	8.5	82
-04MS	R1/2	22	47.8	39.8	14.0	83
KK130S(L)-N01MS	NPT1/8	22	44.3	39.3	6.0	73
-N02MS	NPT1/4	22	47.4	39.9	8.5	74
-N03MS	NPT3/8	22	46.6	39.1	8.5	82
-N04MS	NPT1/2	22	48.2	38.2	14.0	83

*1 Reference dimension after installation

Female thread type

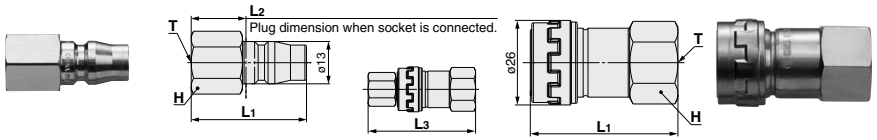

Model	T Connection male thread	H Width across flats	L1	L2	Min. hole size	Weight g	When connected Full length L3
KK130P-01F	Rc1/8	14	30.0	11.1	8.0	18	53.0
-02F	Rc1/4	17	36.0	17.1	8.0	28	62.5
-03F	Rc3/8	21	37.0	18.1	8.0	38	66.5
-04F	Rc1/2	27	42.0	23.1	8.0	73	76.0
KK130P-N01F	NPT1/8	14	30.0	11.1	8.0	18	53.0
-N02F	NPT1/4	17	36.0	17.1	8.0	28	62.5
-N03F	NPT3/8	21	37.0	18.1	8.0	38	66.5
-N04F	NPT1/2	27	42.0	23.1	8.0	73	76.0

Model	T Connection male thread	H Width across flats	L1	Min. hole size	Weight g
KK130S(L)-01F	Rc1/8	22	41.9	8.0	90
-02F	Rc1/4	22	45.4	11.0	92
-03F	Rc3/8	22	48.4	11.0	91
-04F	Rc1/2	27	52.9	14.0	117
KK130S(L)-N01F	NPT1/8	22	41.9	8.0	90
-N02F	NPT1/4	22	45.4	11.0	92
-N03F	NPT3/8	22	48.4	11.0	91
-N04F	NPT1/2	27	52.9	14.0	117

Barb fitting type (for rubber hose)

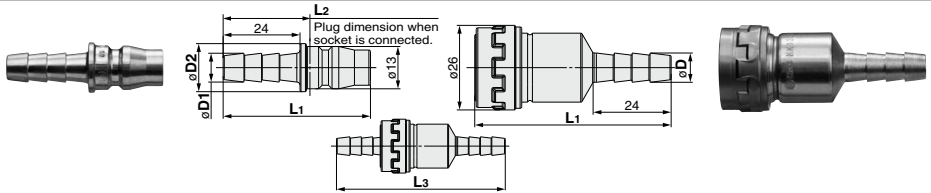

Model	Hose nominal	øD1	øD2	L1	L2	Min. hole size	Weight g	When connected Full length L3
KK130P-07B	6 (1/4")	7.2	14.0	46.0	27.1	4.5	16	88.0
-09B	8 (1/4")	9.0	15.0	46.0	27.1	5.0	19	87.5
-11B	9 (3/8")	11.3	16.0	46.0	27.1	8.0	19	87.0
-13B	12 (1/2")	15.0	18.0	46.0	27.1	8.0	33	86.0

* The figures in () indicate the internal diameter of the applicable hose.

Model	Hose nominal	øD1	L1	Min. hole size	Weight g
KK130S(L)-07B	6 (1/4")	7.2	60.9	4.5	70
-09B	8 (1/4")	9.0	60.4	5.0	72
-11B	9 (3/8")	11.3	59.9	7.7	73
-13B	12 (1/2")	15.0	58.9	9.0	81

* The figures in () indicate the internal diameter of the applicable hose.

Plug (KK130P)

Socket (KK130S, L)

Nut fitting type (for fiber reinforced urethane hose)

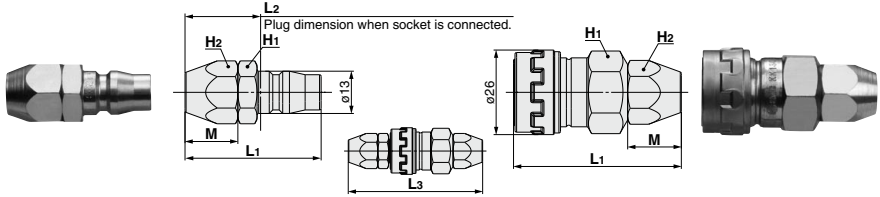

Model	Applicable hose I.D./O.D.	H1	H2	L1	L2	M	Min. hole size	Weight g	When connected Full length L3
KK130P-50N	5/8	14	14	39.7	20.8	13.7	4.5	27	70.4
-60N	6/9	17	17	42.4	23.5	16.4	5.5	42	75.1
-65N	6.5/10	17	17	42.5	23.6	16.5	6.0	39	75.2
-80N	8/12	19	19	43.4	24.5	17.4	8.0	46	77.1
-85N	8.5/12.5	19	19	43.4	24.5	17.4	8.0	48	77.1
-110N	11/16	24	24	49.1	30.2	20.1	8.0	86	82.8

Model	Applicable hose I.D./O.D.	H1	H2	L1	M	Min. hole size	Weight g
KK130S(L)-50N	5/8	22	14	49.6	13.7	4.5	85
-60N	6/9	22	17	51.6	16.4	5.5	95
-65N	6.5/10	22	17	51.6	16.5	6.0	92
-80N	8/12	22	19	52.6	17.4	8.0	97
-85N	8.5/12.5	22	19	52.6	17.4	8.0	101
-110N	11/16	24	24	52.6	20.1	10.0	119

One-touch fitting type

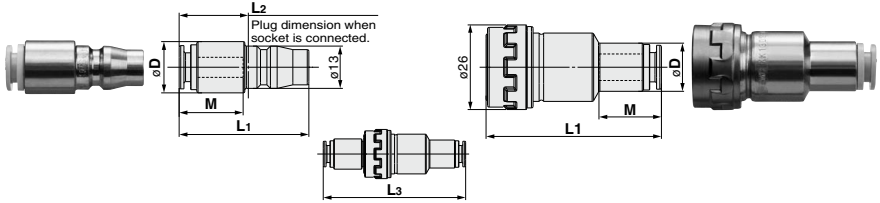

Model	Applicable tube O.D. mm	D	L1	L2	M	Min. hole size	Weight g	When connected Full length L3
KK130P-06H	6	15.0	39.9	21.0	16.7	4.5	24	73.3
-08H	8	16.0	39.9	21.0	18.6	6.0	24	74.3
-10H	10	18.0	40.4	21.5	20.7	8.0	24	76.8
-12H	12	20.0	42.7	23.8	21.7	8.0	29	79.1
-07H	1/4"	15.0	39.9	21.0	16.7	4.5	24	73.3
-09H	5/16"	16.0	39.9	21.0	18.6	6.0	24	74.3
-11H	3/8"	18.0	40.4	21.5	20.7	7.0	25	76.8
-13H	1/2"	20.0	42.7	23.8	21.7	8.0	27	79.1

Model	Applicable tube O.D. mm	D	L1	M	Min. hole size	Weight g
KK130S(L)-06H	6	13.0	52.3	16.7	4.5	72
-08H	8	14.8	53.3	18.6	6.0	74
-10H	10	17.8	55.3	20.7	9.0	77
-12H	12	20.0	55.3	21.7	9.0	80
-07H	1/4"	13.0	52.3	16.7	4.5	72
-09H	5/16"	14.8	53.3	18.6	6.0	74
-11H	3/8"	17.6	55.3	20.7	7.0	79
-13H	1/2"	20.0	55.3	21.7	9.0	78

- QK2
- QKB2
- KS
- KX
- KM
- KF
- M
- H/DL
- L/LL
- KC
- KK
- KK130
- DM
- KDM
- KB
- KR
- KA
- KQ62
- KG
- KFG2
- MS
- KKA
- KP
- LQ
- MQR
- T
- IDK

KK130 Series

How to Operate

Mounting

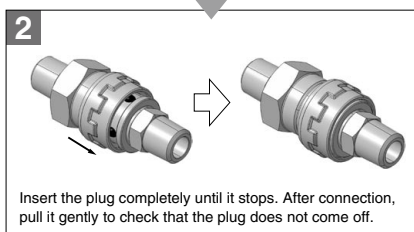
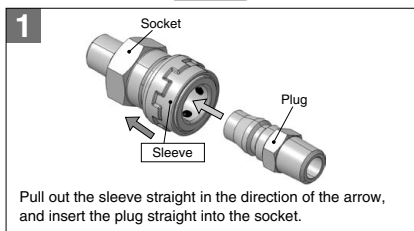

Releasing

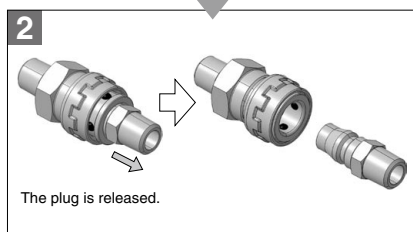
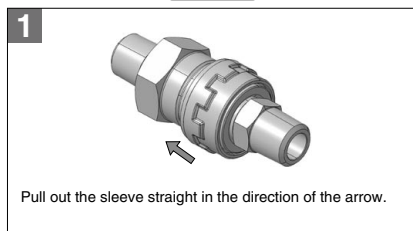

With sleeve lock mechanism (Semi-standard)

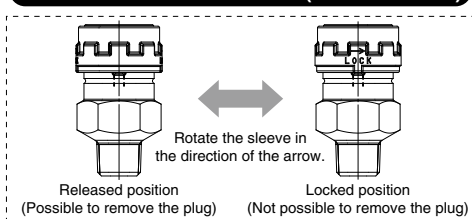

Note) Do not apply pressure when rotating the sleeve. If it is pressurized during rotation, the detent of the locked and released positions may become unclear due to the pressure. In addition, operate the product in accordance with the arrows on the sleeve surface. Failure to do so may result in problems with the attaching and detaching of the mechanism.

Mounting

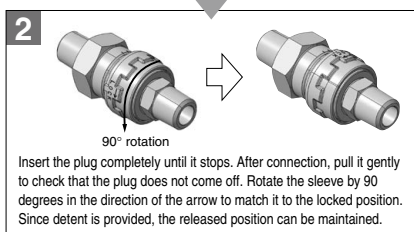
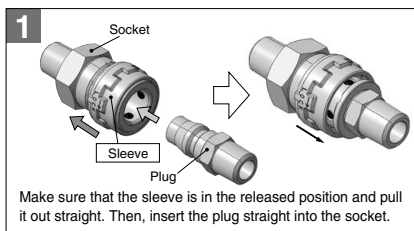

Releasing

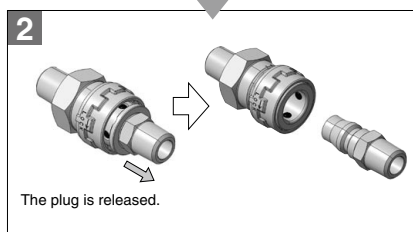
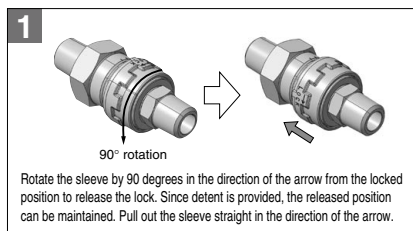

KQ2
KQB2
KS KX
KM
KF
M
H/DL L/LL
KC
KK
KK130
DM
KDM
KB
KR
KA
KQG2
KG
KFG2
MS
KKA
KP
LQ
MQR
T
IDK

KQ2
KQB2
KS KX
KM
KF
M
H/DL L/LL
KC
KK
KK130
DM
KDM
KB
KR
KA
KQG2
KG
KFG2
MS
KKA
KP
LQ
MQR
T
IDK

KQ2
KQB2
KS KX
KM
KF
M
H/DL L/LL
KC
KK
KK130
DM
KDM
KB
KR
KA
KQG2
KG
KFG2
MS
KKA
KP
LQ
MQR
T
IDK