

Speed Exhaust Controller

ASV Series

Size: M3, M5, 1/8, 1/4, 3/8



How to Order

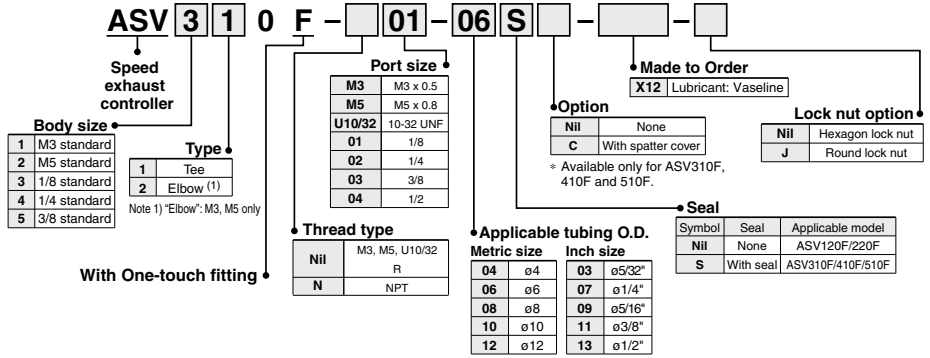

Integration of a quick exhaust valve and an exhaust restrictor permits high-speed cylinder operation.

- The flow rate is approximately twice. (In comparison with control by speed controller)
Applicable model: ASV310F, ASV410F, ASV510F
- Silencer and One-touch fittings are installed.
- Flame resistant resin body as standard. (UL standard V-0)
Applicable model: ASV310F, ASV410F, ASV510F
- Brass parts are all electroless nickel plated.

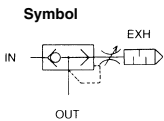

Made to Order



Lubricant: Vaseline

X12

Ex.) ASV120F-M3-04-X12

Note) Only for ASV120F and ASV220F
1068

Model

Model	Port size	Applicable tubing O.D. (mm)										Sonic conductance dm ³ /(s·bar)		Critical pressure ratio			
		4	6	8	10	12	5/32	1/4	5/16	3/8	1/2	IN→OUT	OUT→EXH	IN→OUT	OUT→EXH		
ASV120F-M3	M3 x 0.5	●												0.06	0.06	0.15	
ASV220F-M5	M5 x 0.8	●	●											0.26	0.26		
ASV310F-01	R 1/8		●	●										1.4	1.6		
ASV310F-02	R 1/4		●	●										1.4	1.6	0.35	
ASV410F-01	R 1/8		●	●										2.7	2.8		
ASV410F-02	R 1/4		●	●										2.7	2.8		
ASV410F-03	R 3/8		●	●										2.7	2.8		
ASV510F-02	R 1/4		●	●	●									4.6	5.4		
ASV510F-03	R 3/8		●	●	●									5.4	5.8		
ASV510F-04	R 1/2		●	●	●									5.4	5.8	0.25	
ASV220F-U10/32	10-32 UNF					●	●							0.26	0.26		
ASV310F-N01	NPT 1/8							●	●					1.4	1.6	0.35	
ASV310F-N02	NPT 1/4							●	●					1.4	1.6		
ASV410F-N01	NPT 1/8							●	●					2.7	2.8		
ASV410F-N02	NPT 1/4							●	●					2.7	2.8		
ASV410F-N03	NPT 3/8							●	●					2.7	2.8		
ASV510F-N02	NPT 1/4							●	●	●				4.6	5.4		
ASV510F-N03	NPT 3/8							●	●	●				5.4	5.8		
ASV510F-N04	NPT 1/2							●	●	●				5.4	5.8		

Specifications

Series	ASV120F	ASV220F	ASV310F/410F	ASV510F
Fluid	Air			
Proof pressure	1.5 MPa			
Max. operating pressure	1 MPa			
Min. operating pressure	0.1 MPa			
Ambient and fluid temperature	-5 to 60°C (No freezing)			
Applicable tubing material (Note)	Nylon, Soft nylon, Polyurethane			
Option	Round lock nut		With spatter cover, Round lock nut	

Note) Use caution regarding the max. operating pressure when soft nylon or polyurethane tubing is used. (Refer to pages 678 and 682 for details.)



Needle Valve/Flow Rate Characteristics

Note) The flow rate characteristics are representative values.

ASV120F
OUT-Exhaust Flow

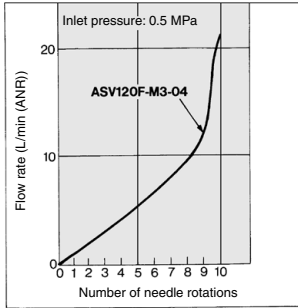

ASV310F
IN-OUT Flow

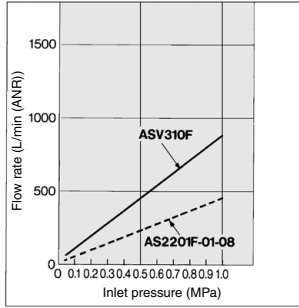

OUT-Exhaust Flow

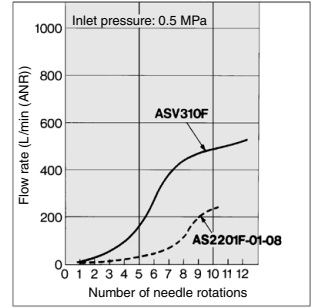

ASV220F
OUT-Exhaust Flow

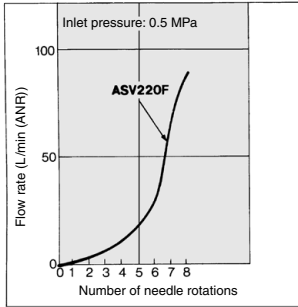

ASV410F
IN-OUT Flow

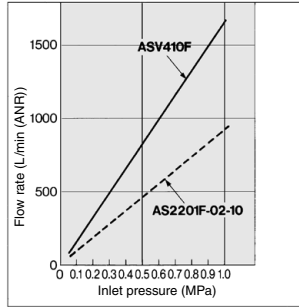

OUT-Exhaust Flow

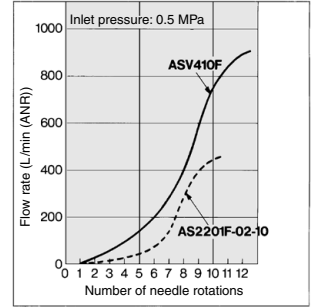

ASV510F

IN-OUT Flow

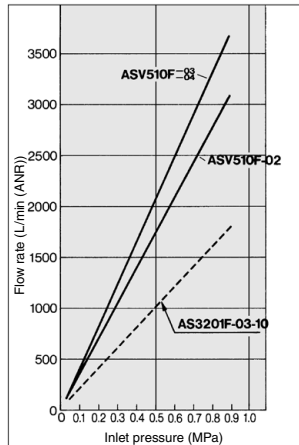

OUT-Exhaust Flow

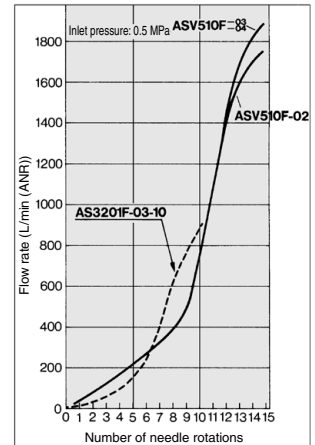

ASV Series

Construction

ASV120F/220F

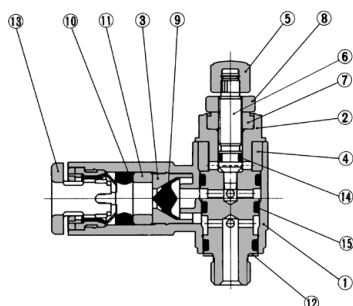

ASV310F/410F/510F

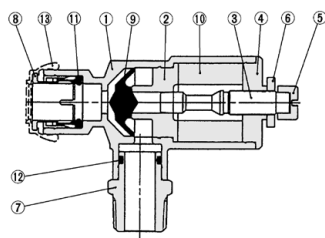

Component Parts

No.	Description	Material	Note
1	Body A	PBT	
2	Body B	Brass ⁽¹⁾	Electroless nickel plated
3	Seat ring	Brass	Electroless nickel plated
4	Silencer	PVA sponge	
5	Handle	PBT	M3 type: Electroless nickel plated brass
6	Needle	Brass	Electroless nickel plated
7	Needle guide	Brass	Electroless nickel plated
8	Lock nut	Steel ⁽³⁾	Zinc chromated ⁽²⁾
9	Valve	HNBR	
10	Seal	NBR	
11	Spacer	POM	
12	Gasket	Stainless steel/NBR	M3 port : PVC
13	Cassette	—	
14	O-ring	NBR	
15	O-ring	NBR	

Note 1) M3 type is made of stainless steel.

Note 2) The round lock nut is electroless nickel plated.

Note 3) The round lock nut is made of brass.

Component Parts

No.	Description	Material	Note
1	Body A	PBT	UL94V-0
2	Seat ring	Aluminum alloy	Chromate plated
3	Needle	Aluminum alloy	Electroless nickel plated
4	Needle guide	Aluminum alloy	Electroless nickel plated
5	Handle	Brass	Electroless nickel plated
6	Lock nut	Steel ⁽²⁾	Zinc chromated ⁽¹⁾
7	Needle guide	Brass	Electroless nickel plated
8	Cassette	—	
9	Valve	Urethane rubber	
10	Silencer	PVA sponge	
11	Seal	NBR	
12	O-ring	NBR	
13	Cover	Flame proof CR	UL94V-0

Note 1) The round lock nut is electroless nickel plated.

Note 2) The round lock nut is made of brass. However,

note that only the ASV310F and ASV410F use steel.

Circuit

Circuit of speed exhaust controller

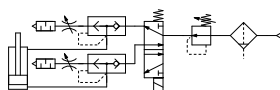

Controlled by speed controller

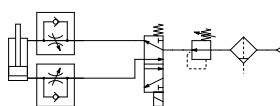

⚠ Specific Product Precautions

Be sure to read this before handling the products.
Refer to page 11 for safety instructions and pages 19 to 22 for flow control equipment precautions.

Design/Selection

⚠ Caution

- In the following cases, insufficient exhaust or vibration may cause noise.
 - With residual pressure or back pressure on the IN side.
 - When the differential pressure between the IN and OUT sides is smaller than the minimum operating pressure.
 - When the effective area of the IN side piping of ASV, or the solenoid valve, is smaller than ASV.
- As the speed exhaust valve ASV220F series has a sonic conduction that is smaller than that of the speed controller AS1201F series, the cylinder speed may not become fast depending on the piping conditions. So, carefully check this point when using the product.
- In the case of applications where the IN side is constantly pressurized, there is a risk of exhaust failure.

Compared to the state where the IN side is open to the atmosphere (no pressurization), the differential pressure that operate the valve become larger, which may cause exhaust failure.

Dimensions

ASV120F/220F

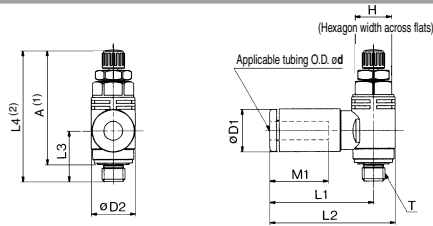

Metric Size

Model	Applicable tubing O.D. ød	T	H	D1	D2	L1	L2	L3	L4		A*		M1	Weight (g)
									Max.	Min.	Max.	Min.		
ASV120F-M3-04	4	M3 x 0.5	5.5	9.3	7.2	21.4	25	9.8	28.6	26.1	25.8	23.3	12.7	5
ASV220F-M5-04	4	M5 x 0.8	8	9.3	9.6	22.8	27.6	11.1	31.4	28.6	27.7	24.9	12.7	8
ASV220F-M5-06	6	M5 x 0.8	8	11.6	9.6	23.6	28.4	11.1	31.4	28.6	27.7	24.9	13.5	9

Note 1) Reference dimensions of M thread after installation. Note 2) L4: Reference dimensions

Inch Size

Model	Applicable tubing O.D. ød	T	H	D1	D2	L1	L2	L3	L4		A*		M1	Weight (g)
									Max.	Min.	Max.	Min.		
ASV220F-U10/32-03	5/32"	10-32UNF	8	9.3	9.6	22.8	27.6	11.1	31.4	28.6	27.7	24.9	12.7	8
ASV220F-U10/32-07	1/4"	10-32UNF	8	12	9.6	23.6	28.4	11.1	31.4	28.6	27.7	24.9	13.7	9

Note 1) Reference "U10/32" thread dimensions after installation.

Note 2) L4: Reference dimensions

ASV310F/410F/510F

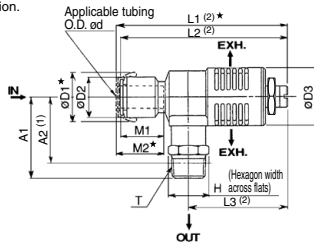

Metric Size

Model	Applicable tubing O.D. ød	T	H	D1	D2	D3	L1*		L2		L3		A1 (2)	A2	M1	M2*	Weight (g)
							Max.	Min.	Max.	Min.	Max.	Min.					
ASV310F-01-06S	6	R1/8	10	16.8	12.8	17.6	71.9	65.9	69.9	63.9	45.8	39.8	26.5	23.4	17	19	22
ASV310F-01-08S	8						73.8	67.8	71.8	65.8							
ASV310F-02-06S	6						71.9	65.9	69.9	63.9							
ASV310F-02-08S	8	R1/4	14	19.3	15.2	17.6	73.8	67.8	71.8	65.8	45.8	39.8	30.9	25.4	19	21	31
ASV410F-01-08S	8						83.1	75.6	81.1	73.6							
ASV410F-01-10S	10						85.2	77.7	83.2	75.7							
ASV410F-02-08S	8	R1/4	14	19.3	15.2	24	83.1	75.6	81.1	73.6	52.8	45.3	29.8	26.7	19	21	31
ASV410F-02-10S	10						85.2	77.7	83.2	75.7							
ASV410F-03-08S	8						83.1	75.6	81.1	73.6							
ASV410F-03-10S	10	R3/8	17	23.3	18.5	24	85.2	77.7	83.2	75.7	52.8	45.3	35.6	30.4	21	23	49
ASV510F-02-10S	10						88.2	82.2	86.2	80.2							
ASV510F-02-12S	12						89.8	83.8	87.8	81.8							
ASV510F-03-10S	10	R1/4	17	23.3	18.5	30	88.2	82.2	86.2	80.2	53.6	47.6	39.3	33.8	22	24	74
ASV510F-03-12S	12						89.8	83.8	87.8	81.8							
ASV510F-04-10S	10						88.2	82.2	86.2	80.2							
ASV510F-04-12S	12	R1/2	22	23.3	18.5	30	89.8	83.8	87.8	81.8	53.6	47.6	44.9	37.6	22	24	100
ASV510F-04-12S	12						89.8	83.8	87.8	81.8							

* Dimension with cover Note 1) Reference dimension of "R" thread after installation. Note 2) L1, L2, L3: Reference dimensions

Inch Size

Model	Applicable tubing O.D. ød	T	H	D1*	D2	D3	L1*		L2		L3		A1 (2)	A1 (1)	M1	M2*	Weight (g)
							Max.	Min.	Max.	Min.	Max.	Min.					
ASV310F-N01-07	1/4"	NPT1/8	12.7	17.2	13.2	17.6	73	67	71	65	45.8	39.8	26.5	23.4	16.8	18.8	22
ASV310F-N01-09	5/16"						73.8	67.8	71.8	65.8							
ASV310F-N02-07	1/4"						73	67	71	65							
ASV310F-N02-09	5/16"	NPT1/4	14.3	19.3	15.2	17.6	73.8	67.8	71.8	65.8	45.8	39.8	30.9	25.4	19	21	31
ASV410F-N01-09	5/16"						83.1	75.6	81.1	73.6							
ASV410F-N01-11	3/16"						85.2	77.7	83.2	75.7							
ASV410F-N02-09	5/16"	NPT1/8	12.7	19.3	15.2	24.4	83.1	75.6	81.1	73.6	52.8	45.3	29.8	26.7	19	21	31
ASV410F-N02-11	3/16"						85.2	77.7	83.2	75.7							
ASV410F-N03-09	5/16"						83.1	75.6	81.1	73.6							
ASV410F-N03-11	3/16"	NPT3/8	17.5	19.3	15.2	24.4	85.2	77.7	83.2	75.7	52.8	45.3	35.6	30.4	21	23	63
ASV510F-N02-11	3/16"						88.2	82.2	86.2	80.2							
ASV510F-N02-13	1/2"						89.8	83.8	87.8	81.8							
ASV510F-N03-11	3/16"	NPT1/4	17.5	23.3	18.5	30	88.2	82.2	86.2	80.2	53.6	47.6	39.3	33.8	21	23	69
ASV510F-N03-13	1/2"						89.8	83.8	87.8	81.8							
ASV510F-N04-11	3/16"						88.2	82.2	86.2	80.2							
ASV510F-N04-13	1/2"	NPT1/2	22.2	23.3	18.5	30	89.8	83.8	87.8	81.8	53.6	47.6	44.9	37.6	21	23	95
ASV510F-N04-13	1/2"						89.8	83.8	87.8	81.8							

* Dimension with cover Note 1) Reference dimension of "NPT" thread after installation. Note 2) L1, L2, L3: Reference dimensions