

Check Valve

	Series	Page
Check Valve	AP64	P.786

Vacuum Generator

	Series	Page
Vacuum Generator	AP7 & 70	P.788
Vacuum Generator Module	AP71	P.790
Vacuum Generator Module	AP72	P.792

Flow Switch

	Series	Page
Flow Switch	AP74	P.794
Flow Switch (For high flow)	AP74B	P.796

Check Valve, Vacuum Generator and Flow Switch/ Specific Product Precautions		P.798
--	--	-------

- AP**
- SL**
- AZ**
- AK**
- BP**

Check Valve

AP64 Series

- Simple design with free of springs and poppets
- Reseals with minimal back pressure
- Low cracking pressure



RoHS

How to Order

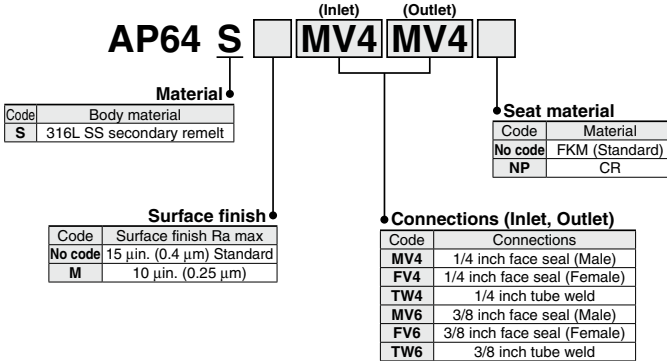

Specifications

Operating Parameters		AP64
Gas		Select compatible materials of construction for the gas
Inlet pressure		Vacuum to 3500 psig (24.1 MPa)
Cracking pressure *1)		3 psi (0.023 MPa) differential *2)
Maximum back pressure		3500 psig (24.1 MPa)
Proof pressure		1.5 times the maximum operating pressure
Burst pressure		3 times the maximum operating pressure
Ambient and operating temperature		-10 to 71°C (No freezing) *3)
Cv		0.4 max
Leak rate	Inboard leakage	2 x 10 ⁻¹¹ Pa·m ³ /s
	Outboard leakage	2 x 10 ⁻¹¹ Pa·m ³ /s *4)
Surface finish		Ra max 15 µin. (0.4 µm) Option: 10 µin. (0.25 µm)
Connections		Face seal, Tube weld
Internal volume		0.122 in. ³ (2 cm ³)
Weight		0.02 kg *5)

*1) Cracking pressure is a nominal value which may vary depending on the application and operating conditions.

*2) 6 psi (0.04 MPa) differential for CR seat.

*3) Max. 50°C for CR seat.

*4) Tested with inlet pressure 500 psig (3.5 MPa).

*5) Weight, including individual boxed weight, may vary depending on connections or options.

Wetted Parts Material

Wetted Parts	S
Body	316L SS secondary remelt
Surface finish	Electropolish + Passivation
Seal	FKM (Option: CR)

Construction

AP64

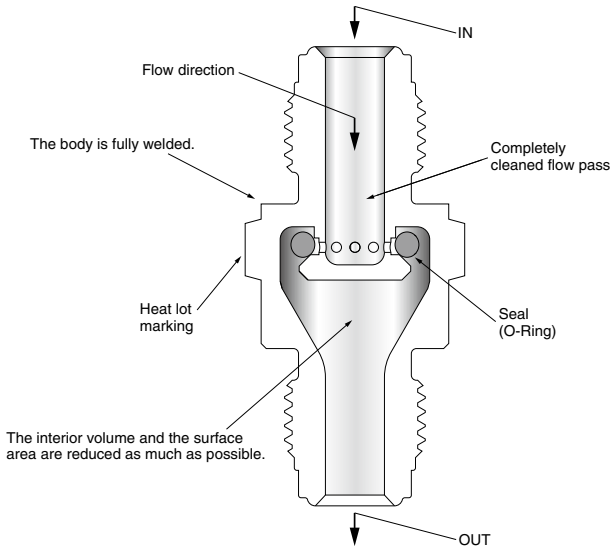

- AP
- SL
- AZ
- AK
- BP

Dimensions

inch (mm)

AP64

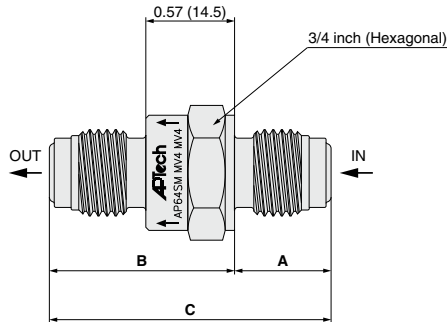

Connections		A		B		C	
Inlet	Outlet	inch	(mm)	inch	(mm)	inch	(mm)
MV4	MV4	0.62	(15.7)	1.19	(30.2)	1.81	(46.0)
MV4	FV4			1.50	(38.1)	2.12	(53.8)
FV4	FV4	0.93	(23.6)	1.50	(38.1)	2.43	(61.7)
FV4	MV4			1.19	(30.2)	2.12	(53.8)
TW4	TW4	0.34	(8.6)	0.91	(23.1)	1.25	(31.8)
MV6	MV6	1.83	(46.5)	2.40	(61.0)	4.23	(107.4)
MV6	FV6						
FV6	MV6						
FV6	FV6						
TW6	TW6	0.34	(8.6)	0.91	(23.1)	1.25	(31.8)

Vacuum Generator

AP7 & 70 Series

- Max. vacuum pressure: -26 in.Hg (-88 kPa)
- AP70 series
 - Compact
 - Fine vacuum efficiency
- AP7 series
 - All connections available with all ports

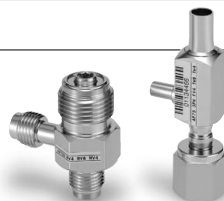

ROHS

How to Order

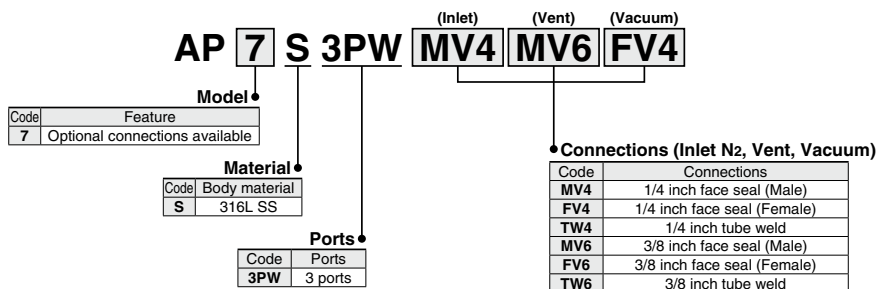
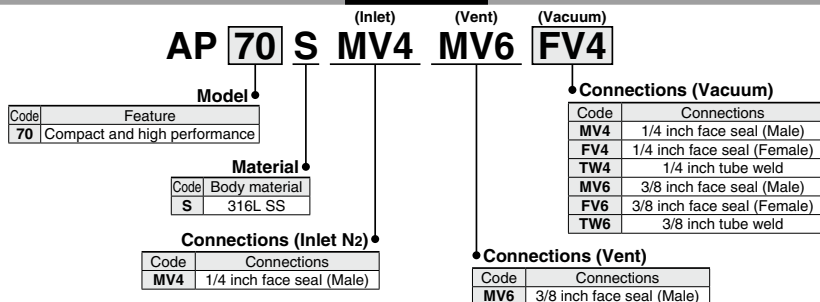

Specifications

Operating Parameters		AP7	AP70
Gas (Inlet N2 port)		N ₂	
Gas (Vacuum port)		Select compatible materials of construction for the gas	
N ₂ Inlet pressure		70 to 110 psig (0.48 to 0.76 MPa)	
Vacuum port maximum pressure		3500 psig (24.1 MPa)	
Proof pressure (Vacuum)		1.5 times the maximum operating pressure	
Burst pressure (Vacuum)		3 times the maximum operating pressure	
Maximum vacuum pressure		-26 in.Hg (-88 kPa) *1)	
Ambient and operating temperature		-40 to 71 °C	
Connections	Inlet	Face seal, Tube weld	1/4 inch face seal (Male)
	Vent	Face seal, Tube weld	3/8 inch face seal (Male)
	Vacuum	Face seal, Tube weld	
Weight		0.11 kg *2)	0.13 kg *2)

*1) At inlet pressure 80 psig (0.55 MPa) and flow rate 60 slpm.

*2) Weight, including individual boxed weight, may vary depending on connections or options.

Wetted Parts Material

Wetted Parts	S
Body	316L SS

Dimensions

inch (mm)

AP7

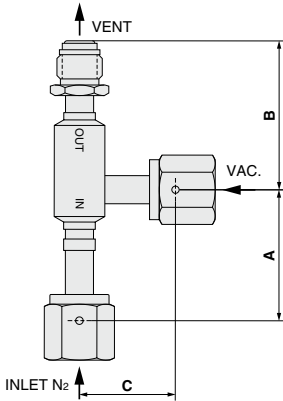

Connections (Inlet)	A	
	inch	(mm)
MV4	1.62	(41.1)
FV4	1.25	(31.8)
MV6	2.13	(54.1)
FV6	2.13	(54.1)
TW6	1.25	(31.8)

Connections (Vent)	B	
	inch	(mm)
MV4	1.83	(46.5)
FV4	1.46	(37.1)
MV6	2.34	(59.4)
FV6	2.34	(59.4)
TW6	1.46	(37.1)

Connections (Vacuum)	C	
	inch	(mm)
MV4	1.18	(30.0)
FV4	0.81	(20.6)
MV6	1.69	(42.9)
FV6	1.69	(42.9)
TW6	0.81	(20.6)

AP70

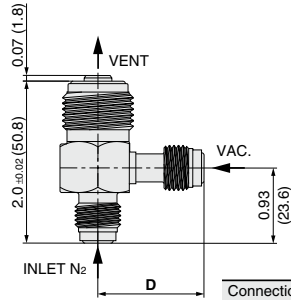

Connections (Vacuum)	D	
	inch	(mm)
MV4	1.31	(33.3)
FV4	0.97	(24.6)
MV6	1.85	(47.0)
FV6	1.85	(47.0)
TW6	0.97	(24.6)

Exhaust Characteristics

AP7

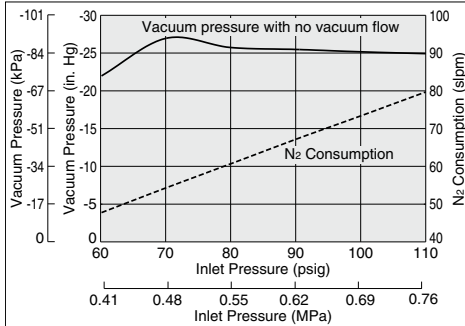

AP70

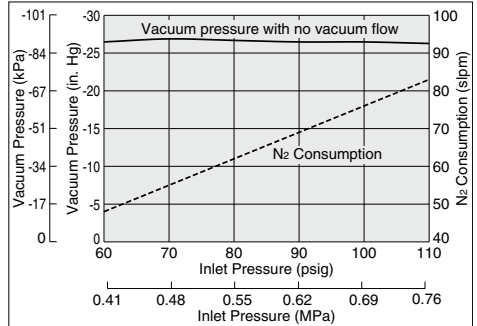

Flow Rate Characteristics

AP7

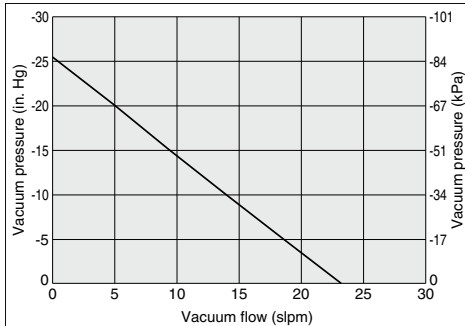

AP70

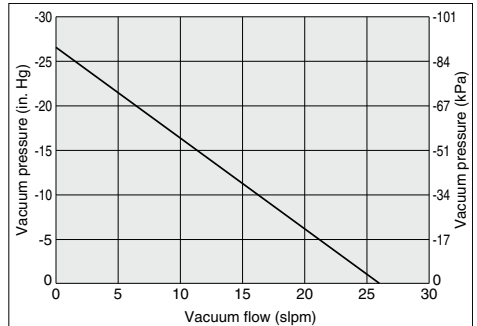

Note) slpm, N₂: The volumetric flow rate under normal conditions (0°C, 1 atm) when N₂ gas is flowing.

AP71 Series

- Unique compact design by integrating vacuum generator, air operated valve and check valve
- Max. vacuum pressure: -26 in.Hg (-88 kPa)
- Integrate N.C. air operated valve
- Constant bleed option to maintain inert vent line



ROHS

How to Order

(Inlet) (Vent) (Vacuum)

AP71 S MV4 FV6 TW4 []

Material

Code	Body material
S	316L SS

Connections (Inlet N₂ port, Vent, Vacuum)

Code	Connections	Inlet	Vent	Vacuum
MV4	1/4 inch face seal (Male)	●	●	●
FV4	1/4 inch face seal (Female)		●	●
TW4	1/4 inch tube weld			●
MV6	3/8 inch face seal (Male)		●	
FV6	3/8 inch face seal (Female)		●	
TW6	3/8 inch tube weld		●	

Bleed options

Code	Bleed options
No code	No bleed option (Standard)
CB005	2.5 slpm
CB009	5 slpm
CB013	8 slpm
CB023	15 slpm

Specifications

Operating Parameters		AP71
Gas (Inlet N ₂ port)		N ₂
Gas (Vacuum)		Select compatible materials of construction for the gas
N ₂ Inlet pressure		70 to 110 psig (0.48 to 0.76 MPa)
Vacuum port maximum pressure		3500 psig (24.1 MPa)
Proof pressure (Vacuum)		1.5 times the maximum operating pressure
Burst pressure (Vacuum)		3 times the maximum operating pressure
Maximum vacuum pressure		-26 in.Hg (-88 kPa) *1)
Ambient and operating temperature		-10 to 71°C
Cracking pressure (Check valve)		3 psid (0.023 MPa)*2)
Air operated	Status	Normally closed (N.C.)
	Actuation pressure	60 to 110 psig (0.4 to 0.76 MPa)
	Actuation port	M5 thread
Connections	Inlet	1/4 inch face seal (Male)
	Vent	1/4, 3/8 inch face seal, 3/8 inch tube weld
	Vacuum	1/4 inch face seal, Tube weld
Weight		0.14 kg *3)

*1) At inlet pressure 80 psig (0.55 MPa) and flow rate 60 slpm.

*2) Cracking pressure is a nominal value which may vary depending on the application and operating conditions.

*3) Weight, including individual boxed weight, may vary depending on connections or options.

Option

Bleed

Bleed option provides constant low flow of N₂ to maintain inert atmosphere in vent line.

Following 4 options are available:

Option	Bleed *
CB005	1 to 2.5 slpm
CB009	2 to 5 slpm
CB013	5 to 8 slpm
CB023	10 to 15 slpm

* At 80 psig (0.55 MPa) N₂ gas.

Wetted Parts Material

Wetted Parts	AP71
Body	316L SS
Poppet	303 SS
Piston	303 SS
Spring	302 SS
Check valve seat	FKM

Construction

AP71

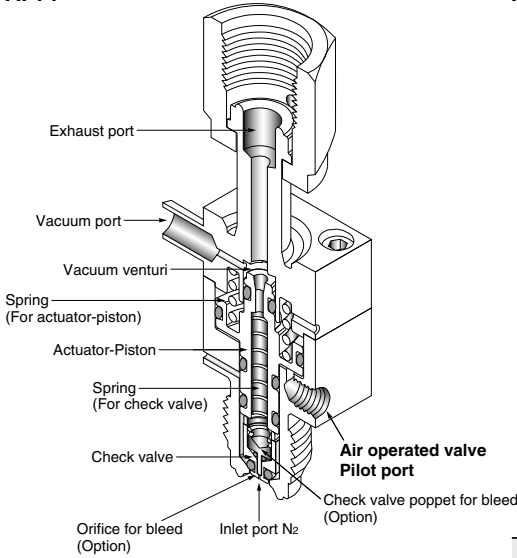

Dimensions

inch (mm)

AP71

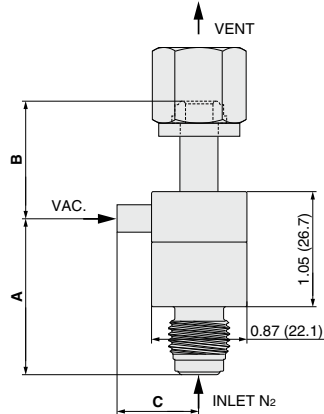

Connections (Inlet)	A	
	inch	(mm)
MV4	1.43	(36.3)

Connections (Vacuum)	C	
	inch	(mm)
MV4	1.39	(35.3)
FV4		
TW4	0.75	(19.1)

Connections (Vent)	B	
	inch	(mm)
MV4	1.07	(27.2)
FV4		
MV6	1.64	(41.7)
FV6		
TW6	0.96	(24.4)

Exhaust Characteristics

AP71

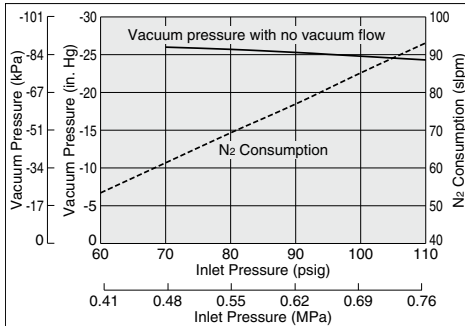

Flow Rate Characteristics

AP71

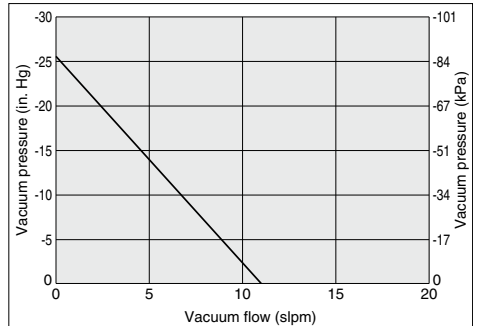

Note) slpm, N₂: The volumetric flow rate under normal conditions (0°C, 1 atm) when N₂ gas is flowing.

AP
SL
AZ
AK
BP

AP72 Series

- Unique compact design by integrating vacuum generator, diaphragm valve and check valve
- Max. vacuum pressure: -26 in.Hg (-88 kPa)
- Air operated or manually operated type is available as diaphragm valve
- Constant bleed option to maintain inert vent line

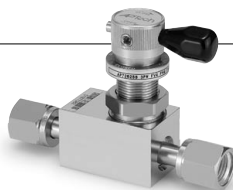

ROHS

How to Order

AP72 **625** **S** **3PW** **MV4** **FV6** **TW4**

(Inlet) (Vent) (Vacuum^③) (Vacuum^④)

Material

Code	Body material
S	316L SS

Ports (Refer to the porting configuration)

Code	Ports
3PW	3 ports
3PWA	3 ports (Angle type)
4PW	4 ports

Model

Code	Actuation	Knob
540	Air operated	—
550		—
600		Multi turn round knob
625	Manual operated	1/4 turn lever knob
650		1/4 turn round knob with open/close indication window

Bleed options

Code	Bleed options
No code	No bleed option (Standard)
CB009	5 slpm
CB013	8 slpm
CB023	15 slpm

Diaphragm valve seat material

Code	Material
No code	PCTFE (Standard)
VS	Polyimide

Connections (Inlet N2 port, Vent, Vacuum^③, Vacuum^④)

Code	Connections	Inlet	Vent	Vacuum ^③	Vacuum ^④
MV4	1/4 inch face seal (Male)	●	●	●	●
FV4	1/4 inch face seal (Female)	●	●	●	●
TW4	1/4 inch tube weld			●	●
MV6	3/8 inch face seal (Male)		●		
FV6	3/8 inch face seal (Female)		●		
TW6	3/8 inch tube weld		●		

* Specify the piping connection method for vacuum side ④ only when port "4PW" is selected.

Porting Configuration

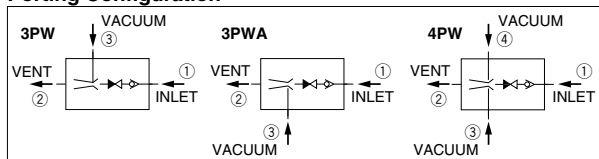

Specifications

Operating Parameters	AP72540	AP72550	AP72600	AP72625	AP72650
Gas (Inlet N2 port)	N ₂				
Gas (Vacuum)	Select compatible materials of construction for the gas				
N ₂ Inlet pressure	70 to 110 psig (0.48 to 0.76 MPa)				
Vacuum port maximum pressure	3000 psig (20.7 MPa)				
Proof pressure (Vacuum)	1.5 times the maximum operating pressure				
Burst pressure (Vacuum)	3 times the maximum operating pressure				
Maximum vacuum pressure	-26 in.Hg (-88 kPa) *1)				
Ambient and operating temperature	-10 to 71°C				
Cracking pressure (Check valve)	3 psid (0.023 MPa) *2)				
Leak rate	Inboard leakage				
	2 x 10 ⁻¹¹ Pa·m ³ /s				
Across the seat leak	Outboard leakage				
	2 x 10 ⁻¹⁰ Pa·m ³ /s *3)				
Connections	Inlet				
	Vent				
	Vacuum				
Weight	1/4, 3/8 inch face seal, 3/8 inch tube weld				
	1/4 inch face seal, 1/4 inch tube weld				
	0.82 kg *4)				

*1) At inlet pressure 80 psig (0.55 MPa) and flow rate 60 slpm.

*2) Cracking pressure is a nominal value which may vary depending on the application and operating conditions.

*3) Tested with Helium gas inlet pressure 250 psig (1.7 MPa), 125 psig (0.9 MPa) for AP72540

*4) Weight, including individual boxed weight, may vary depending on connections or options.

Air operated type

Model	AP72540	AP72550
Status	Normally closed (N.C.)	
Actuation pressure	70 to 110 psig (0.48 to 0.76 MPa)	
Actuation port connection	NPT 1/8 inch	10-32 UNF thread
Actuation port location	Top	Side

Manually operated type

Model	AP72600	AP72625	AP72650
Knob	Multi turn round knob	1/4 turn lever knob	1/4 turn round knob with open/close indication window

Option

Bleed

Provides constant low flow of N₂ to maintain inert atmosphere in vent line.

Following 3 options are available:

Option	Bleed *
CB009	2 to 5 slpm
CB013	5 to 8 slpm
CB023	10 to 15 slpm

* At 80 psig (0.55 MPa) N₂ gas.

Material

Material	S
Body	316L SS
Surface finish	Electropolish + Passivation
Diaphragm	Ni-Co alloy
Diaphragm valve seat	PCTFE (Option: Polyimide)
Check valve seat	FKM

Dimensions

inch (mm)

AP72

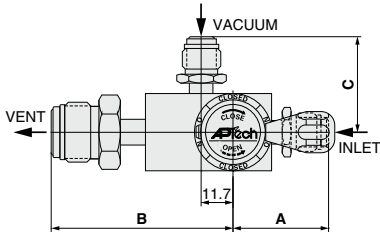

Top view

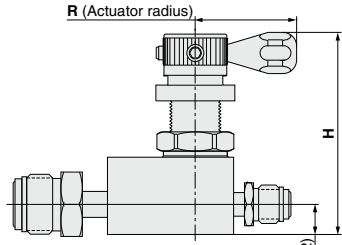

Side view

Model	R		H		Connections (Inlet)		A	
	inch	(mm)	inch	(mm)		inch	(mm)	
AP72540	0.73	(18.5)	3.49	(88.6)	MV4	1.39	(35.3)	
AP72550	0.69	(17.4)	3.28	(83.3)	FV4			
AP72600	1.06	(26.9)	3.00	(67.1)				
AP72625	1.48	(37.6)	2.94	(74.7)				
AP72650	0.94	(23.9)	3.02	(76.7)				

Connections (Vent)	B		Connections (Vacuum)	C	
	inch	(mm)		inch	(mm)
MV4	2.11	(53.6)	MV4	1.39	(35.3)
FV4			FV4		
MV6	2.65	(67.3)	TW4	1.06	(26.9)
FV6					
TW6	2.05	(52.0)			

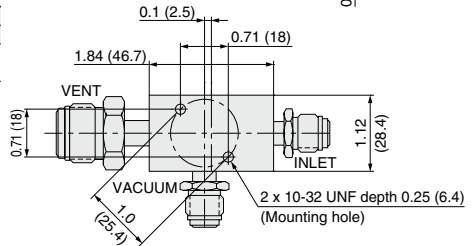

Bottom view

Exhaust Characteristics

AP72

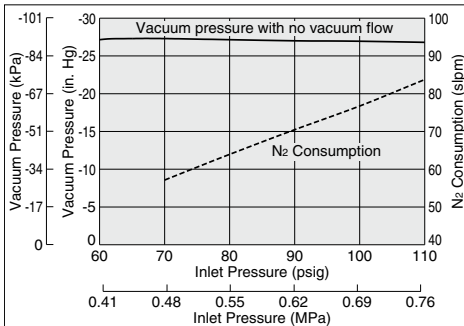

Flow Rate Characteristics

AP72

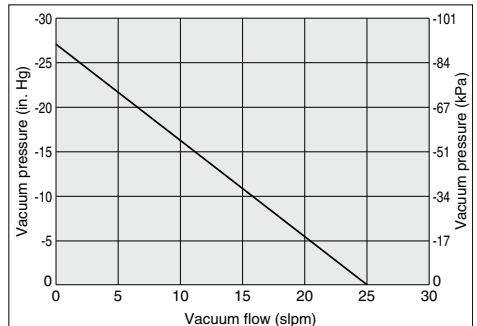

Note) slpm, N₂: The volumetric flow rate under normal conditions (0°C, 1 atm) when N₂ gas is flowing.

AP

SL

AZ

AK

BP

Flow Switch

AP74 Series

- 6 flow trip points available, from 2 to 100 slpm
- Body material: 316L SS secondary remelt
- High pressure Max. 3500 psig (24.1 MPa)
- Detect excess flow by N.C. or N.O. contact output with non-wetted reed switch tripped by float with encapsulated magnet (SPDT, 3 wire / 2 position)



ROHS

How to Order

AP74 **100** S (Inlet) (Outlet) **MV4** **MV4**

Size

Code	Flow trip reference points *1)
002	2 slpm
005	5 slpm
010	10 slpm
025	25 slpm
050	50 slpm
100	100 slpm

*1) To obtain the nominal trip point in process gases other than nitrogen or pressures other than 100 psig (0.69 MPa), please refer to the Precaution of Selection (P.797).

• Connections (Inlet, Outlet)

Code	Connections
MV4	1/4 inch face seal (Male)
FV4	1/4 inch face seal (Female)
TW4	1/4 inch tube weld

• Surface finish

Code	Surface finish Ra max
No code	15 μm. (0.4 μm) Standard
M	10 μm. (0.25 μm)

• Material

Code	Body material
S	316L SS secondary remelt

Specifications

Operating Parameters		AP74002	AP74005	AP74010	AP74025	AP74050	AP74100
Gas		Select compatible materials of construction for the gas					
Source pressure		Vacuum to 3500 psig (24.1 MPa)					
Flow trip reference points *1) *2)		2 slpm	5 slpm	10 slpm	25 slpm	50 slpm	100 slpm
Accuracy		±10% of trip point or 0.5 slpm, whichever is greater					
Installation orientation		Inlet port at the bottom (Vertical within 8°)					
Pressure drop at trip point		0.5 psi (0.0034 MPa) differential *3)					
Proof pressure		1.5 times the maximum operating pressure					
Burst pressure		3 times the maximum operating pressure					
Ambient and operating temperature		-23 to 80°C (No freezing)					
Leak rate	Inboard leakage	2 x 10 ⁻¹¹ Pa·m ³ /s					
	Outboard leakage	2 x 10 ⁻¹¹ Pa·m ³ /s *4)					
Surface finish		Ra max 15 μm. (0.4 μm) Option: 10 μm. (0.25 μm)					
Connections		Face seal, Tube weld					
Reed switch	Type	SPDT (3 wire / 2 position)					
	Power	30 VDC (3 W max)					
	Switching current	0.2 A max					
	Carrying current	0.5 A max					
	Initial contact resistance	0.1 Ω or less					
Cable	Wire gauge	AWG24 (PVC jacket)					
	Cable length	10 ft. (3 m)					
	Lead color	Blue: common Brown: normally closed Black: normally open					
Internal volume		0.12 in ³ (1.9 cm ³)					
Weight		0.11 kg *5)					

*1) Trip point varies slightly with temperature change, ±2% over the specified operating range.

*2) At N₂ gas 100 psig (0.69 MPa). To obtain the nominal trip point in process gases other than nitrogen or pressures other than 100 psig (0.69 MPa), please refer to the Precaution on Selection (P.797).

*3) Pressure drop at trip point.

*4) Tested with Helium gas inlet pressure 500 psig (3.5 MPa).

*5) Weight, including individual boxed weight, may vary depending on connections or options.

Wetted Parts Material

Wetted Parts	S
Body	316L SS secondary remelt
Surface finish	Electropolish + Passivation
Float	316L SS

Dimensions

inch (mm)

AP74

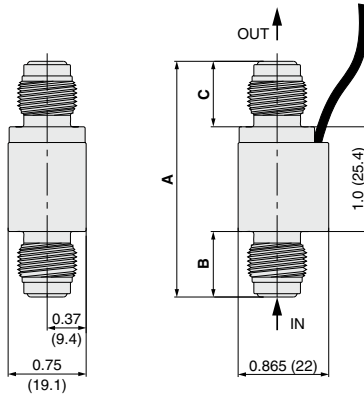

Connections		A		B		C	
Inlet	Outlet	inch	(mm)	inch	(mm)	inch	(mm)
MV4	MV4	2.25	(57.2)	0.625	(15.9)	0.625	(15.9)
FV4	FV4	3.99	(101.4)	1.495	(38.0)	1.495	(38.0)
TW4	TW4	2.25	(57.2)			0.625	(15.9)
MV4	FV4	3.12	(79.3)	0.625	(15.9)	1.495	(38.0)
MV4	TW4	2.25	(57.2)				
FV4	MV4	3.12	(79.3)	1.495	(38.0)	0.625	(15.9)
FV4	TW4						
TW4	MV4	2.25	(57.2)	0.625	(15.9)		
TW4	FV4	3.12	(79.3)			1.495	(38.0)

- AP**
- SL**
- AZ**
- AK**
- BP**

Flow Switch

For high flow

AP74B Series

- Bypass design suitable for high flow (BSGS) application
- 7 flow trip points available, from 225 to 2600 slpm
- Horizontal or vertical installation orientation is available
- Main line 1/2 inch or 3/4 inch size available



RoHS

How to Order

AP74B **V** **500** **S** **M** **FV8** **MV8**

Installation orientation

Code	Orientation
H	Horizontal
V	Vertical

Size

Code	Flow trip reference points *1)
225	225 slpm
350	350 slpm
500	500 slpm
950	950 slpm
1100	1100 slpm
1650	1650 slpm
2600	2600 slpm

*1) As N₂ gas 100 psig (0.69 MPa). To obtain the nominal trip point in process gases other than nitrogen or pressures other than 100 psig (0.69 MPa), please refer to the Precaution on Selection (P.797).

Surface finish

Code	Surface finish Ra max
M	10 μin. (0.25 μm)

Material

Code	Body material
S	316L SS

Connections

Code	Connections (Inlet, Outlet)	Size						
		225	350	500	950	1100	1650	2600
MV8	1/2 inch face seal (Male)	●	●	●	●			
FV8	1/2 inch face seal (Female)	●	●	●	●			
TW8	1/2 inch tube weld	●	●	●	●			
MV12	3/4 inch face seal (Male) *2)					●	●	●
FV12	3/4 inch face seal (Female) *2)					●	●	●
TW12	3/4 inch tube weld					●	●	●

*2) Prepare a suitable mating fitting with a rated pressure.

Installation Orientation

AP74BH Horizontal

AP74BV Vertical

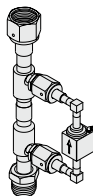
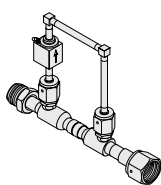

Specifications

Operating parameters		AP74B□225	AP74B□350	AP74B□500	AP74B□950	AP74B□1100	AP74B□1650	AP74B□2600
Gas		Select compatible materials of construction for the gas						
Source pressure		Vacuum to 3500 psig (24.1 MPa)			Vacuum to 3000 psig (20.7 MPa)			
Flow trip reference points *1) *2)		225 slpm	350 slpm	500 slpm	950 slpm	1100 slpm	1650 slpm	2600 slpm
Accuracy		±20% of trip point						
Proof pressure		1.5 times the maximum operating pressure						
Burst pressure		3 times the maximum operating pressure						
Ambient and operating temperature		-23 to 80°C (No freezing)						
Leak rate	Inboard leakage	2 x 10 ⁻¹¹ Pa·m ³ /s						
	Outboard leakage	2 x 10 ⁻¹¹ Pa·m ³ /s						
Surface finish		Ra max 10 μin. (0.25 μm)						
Connections		1/2 inch face seal, Tube weld			3/4 inch face seal, Tube weld			
Pressure drop at trip point		0.5 psi (0.0034 MPa) differential *3)						
Reed switch	Type	SPDT, 3 wire / 2 position						
	Power	30 VDC (3 W max)						
	Switching current	0.2 A max						
	Carrying current	0.5 A max						
Cable	Initial contact resistance	0.1 Ω max						
	Wire gauge	AWG24 (PVC jacket)						
	Cable length	10 ft. (3 m)						
Lead color		Blue: common						
		Brown: normally closed						
		Black: normally open						
Weight		0.56 kg *4)						

*1) Trip point varies slightly with temperature change, ±2% over the specified operating range.

*2) At N₂ gas 100 psig (0.69 MPa). To obtain the nominal trip point in process gases other than nitrogen or pressures other than 100 psig (0.69 MPa), please refer to the Precautions on Selection (P.797).

*3) Pressure drop at trip point

*4) Weight, including individual boxed weight, may vary depending on connections or options.

Wetted Parts Material

Wetted Parts	S
Body	316L SS
Surface finish	Electropolish + Passivation
Float	316L SS
Metal gasket	Nickel 200

Dimensions

inch (mm)

AP74B

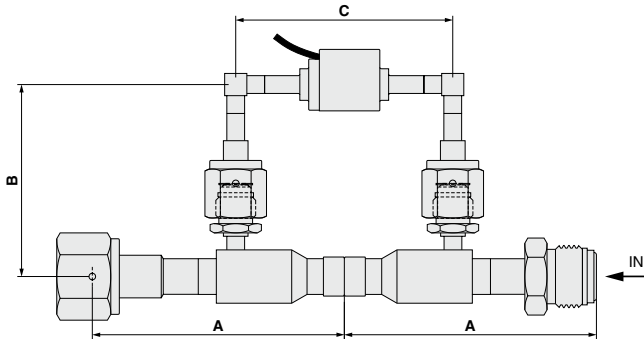

Connections	A		B				C	
	inch	(mm)	Horizontal		Vertical		inch	(mm)
MV8	3.55	(90.2)	4.55	(115.6)	2.70	(68.6)	3.05	(77.5)
FV8								
TW8	2.59	(65.8)	5.44	(138.2)	3.59	(91.2)		
MV12	5.51	(140.0)						
FV12	5.51	(140.0)	5.44	(138.2)	3.59	(91.2)		
TW12								

AP
SL
AZ
AK
BP

⚠ Precaution on Selection

Nominal flow trip reference points are at 100 psig (0.69 MPa) of N₂ gas. In order to obtain the nominal trip point for operating pressure, other than 100 psig (0.69 MPa), and for gas, other than N₂, calculate the correction factors (F_p, F_g) with the following formula and then, multiply both factors.

1. Change in operating pressure

$$F_p = \sqrt{\frac{OP}{114.7}}$$

$$\left(F_p = \sqrt{\frac{OP_{MPa}}{0.79}} \right)$$

OP: Operating pressure (abs) psia
(OP_{MPa}: Operating pressure (abs) MPa abs)

2. Change in gas type

$$F_g = \sqrt{\frac{28}{MW}}$$

MW: Molecular weight of the gas

E.g) Nominal trip point when gas type is hydrogen gas (molecular weight: 2) and operating pressure is 0.5 MPa:

1. Calculation of F_p

$$F_p = \sqrt{\frac{(0.5 + 0.1)}{0.79}} = 0.871$$

2. Calculation of F_g

$$F_g = \sqrt{\frac{28}{2}} = 3.742$$

When using the flow switch, whose nominal trip point is 10 slpm (AP74010S□), under these conditions, its nominal trip point will be 32.6 slpm (10 (slpm) x 0.871 x 3.742 = 32.6 (slpm)).



Process Gas Equipment/Check Valve Specific Product Precautions

Be sure to read this before handling the products.

Refer to back page 50 for Safety Instructions and pages 633 and 634 for Process Gas Equipment Precautions.

Selection

Warning

1. Confirm the specifications.

This product is used in gas delivery systems to prevent reverse gas flow. This product can only supply gas from inlet to outlet side. When selecting the product, confirm the operating conditions, such as type of gas, operating pressure, flow rate, operating temperature etc., and use within the operating range specified in the catalog. The product may not be suitable for use with specific gases and applications/environments. Check the compatibility of the product materials with the process gas. Confirm the compatibility of the product materials with the process gas in the catalog selection guide. Design the equipment and select the product by understanding the characteristics of gas.

Mounting

Caution

1. Confirm the mounting direction of the product.

An arrow is indicated on the product. The arrow points in the direction flow are allowed from the inlet side towards the outlet side.

Maintenance

Warning

1. AP64 check valves cannot be repaired.

AP Tech AP64 check valves are welded shut and internal problems usually cannot be repaired.

Operation

Caution

1. Do not use the check valve as shutoff valve.

Do not rely on a check valve exclusively to absolutely prevent any reverse flow, especially when the pressure differential is small. For situations where it is known the downstream pressure will exceed the upstream pressure, use a diaphragm valve to positively shut off reverse flow.



Process Gas Equipment/Vacuum Generator Specific Product Precautions

Be sure to read this before handling the products.

Refer to back page 50 for Safety Instructions and pages 633 and 634 for Process Gas Equipment Precautions.

Selection

Warning

1. Confirm the specifications.

This product is used in gas delivery systems to assist in purging of piping systems. When selecting the product, confirm the operating conditions, such as type of process gas being vented, nitrogen supply pressure and flow rate, vent line back pressure generated by the nitrogen supply flow rate, actuation pressure, operating temperature etc., and use within the operating range specified in the catalog. The product may not be suitable for use with specific gases and applications/ environments. Check the compatibility of the product materials with the process gas. Confirm the compatibility of the product with the process gas in the catalog selection guide. Design the equipment and select the product by understanding the characteristics of gas.

Mounting

Caution

1. Confirm the mounting direction of the product.

Inlet port is labeled with "IN" mark and outlet port is labeled with "OUT" mark. Alternatively, the nitrogen flow direction may be indicated with an arrow instead of "IN" and "OUT" marks. Inlet and outlet ports run in line with each other. The vacuum port runs perpendicular to the inlet and outlet ports. The vacuum port may be labeled with "VAC" mark. Confirm the mounting direction and install at correct direction.

2. Connect actuation pressure to the valve actuator connection.

If an air operated valve is built in the product, connect actuation pressure to the valve actuator connection. Use nitrogen or clean dry air for actuation pressure.

Maintenance

Warning

1. If a product requires repair, contact SMC.

Operation

Warning

1. Supply nitrogen to the inlet port.

2. If an air operated valve is built in the product, use nitrogen or clean dry air for actuation pressure.

3. Apply nitrogen within the specified pressure range to the inlet port in order to generate a vacuum.

When applying nitrogen to the inlet port, vacuum will be generated. If a valve is built in the product, vacuum will be generated after applying nitrogen to the inlet port and opening the built-in valve. In the case of an air operated valve, it will open when applying actuation pressure to the actuation port. In the case of a manually operated valve, it will open when the handle is rotated counterclockwise until it completely stops.

4. Shut off nitrogen supply in order to shut off vacuum.

When shutting off nitrogen supply to the inlet port, vacuum will be shut off. If a valve is built in the product, vacuum will be shut off when closing the valve. In the case of an air operated valve, it will close when venting off actuation pressure. In the case of a manually operated valve, it will close when rotating the handle clockwise until it completely stops.

5. In the case the check valve is built in the product, back flow through the inlet port will be prevented when pressure on the vacuum or vent ports exceeds the inlet port pressure.

Check valve is used for preventing back flow through the inlet port when pressure on the vacuum or vent ports exceeds the inlet port pressure, regardless of whether the built-in valve is opened or closed, and regardless of whether or not the product has a constant bleed option. However, the check valve does not prevent back flow from the outlet port through the vacuum port.

6. If the product with built-in valve is selected with constant bleed option, when supplying nitrogen pressure to the inlet port, nitrogen will bleed through a small hole to the vacuum and vent ports even when the built-in valve is closed.

AP

SL

AZ

AK

BP



Process Gas Equipment/Flow Switch Specific Product Precautions

Be sure to read this before handling the products.

Refer to back page 50 for Safety Instructions and pages 633 and 634 for Process Gas Equipment Precautions.

Selection

Warning

1. Confirm the specifications.

This product is used in gas delivery systems to signal an increase in flow above a trip point. When selecting the product, confirm the operating conditions, such as type of gas, operating pressure, flow rate, operating temperature, etc., and use within the operating range specified in the catalog. The product may not be suitable for use with specific gases and applications/environments. Check the compatibility of the product materials with the process gas. Confirm the compatibility of the product with the process gas in the catalog selection guide.

Design the equipment and select the product by understanding the characteristics of gas.

2. Confirm the flow trip reference point of the product.

Flow trip reference point is fixed. Select the product which meets the desired flow rate. Flow trip reference point, specified in the How To Order, is the trip point value with nitrogen at 0.69 MPa inlet pressure. When the products are used with other inlet pressures or gases, use the conversion formula to calculate the flow trip reference point for such application.

Mounting

Caution

1. Do not drop or bump the products.

When dropping, bumping, or applying excessive impacts to the products, it may damage inside of the product and cause malfunction.

2. Confirm the mounting direction of the products.

An arrow is indicated on the product. In the case of the AP74B series, an arrow is indicated on the bypass line. The arrow points in the forward flow direction from inlet port to outlet port.

3. Install the products vertically with the inlet port on the bottom in order to supply gases from bottom to top.

In the case of the AP74 series, install the product within 8 degrees of vertical in order to supply gas from bottom to top. In the case of the AP74B series, install the product with its arrow indicated on the bypass line within 8 degrees of vertical in order to make its arrow direction upward.

Wiring

Warning

1. Avoid bending repeatedly or stretching the lead wires.

Lead wire may break when applying bending stress repeatedly or stretching force to the lead wires.

2. Do not wire in conjunction with power lines or high voltage lines.

Wire separately from power lines and high voltage lines and avoid wiring in the same conduit with these lines. Close proximity between power lines or high voltage lines and the product may result in malfunction due to electrical noise.

Wiring

Warning

3. Confirm proper insulation of wiring.

Make sure that there is no insulation failure (contact with other circuits, insulation failure between terminal, etc.). Damage may occur due to excessive current applied to the product.

4. Connect wires properly.

Use brown and blue wires for normally closed contact installation.

Use black and blue wires for normally open contact installation.

5. Do not connect wiring while product is energized.

6. Make sure to connect a load before energizing the product.

Energizing the product without connecting a load (load short-circuit) can create excessive current and damage the switch.

7. Confirm operation of the product by supplying nitrogen after installation and wiring.

Confirm the product trips when supplying nitrogen above the flow trip reference point and that it resets when the flow is shut off.

Operating Environment

Warning

1. Do not use in an area, where a magnetic field is generated. It may cause malfunction.

Maintenance

Warning

1. AP Tech flow switches cannot be repaired.

AP Tech flow switches are welded shut and internal problems usually cannot be repaired.

Operation

Warning

1. Initial pressurization of system lines can cause a temporary flow surge that trips the flow switch.

Confirm flow switch resets once system lines are filled with gas. If it does not reset after system lines are filled, stop supplying gas and check for leakage of the system.